

A Survey Paper on Microelectro Mechanical Beam Filters and Design of Clamped-Free Beam Resonator

B.Ravi Kumar¹, K.Yuvaraj², S.Md.Yousuf³

Assistant Professor, Department of ECE, S V College of Engineering, Tirupati, A.P, India^{1,2,3}

ABSTRACT: The need for different applications leads to various kinds of filter designs and numerous scaling techniques are used. This paper illustrates the basic principle of working of Microelectromechanical resonator which is fundamental part of filter. This resonator can be used in oscillator and filter. This paper also includes the results from the simulation of clamped free beam resonator in COMSOL multiphysics.

KEYWORDS: Beam resonator. MEMS resonator, filter, eigen frequency, Comsol

I. INTRODUCTION

For communication system, it is important to process the signals. Surface acoustic wave device, electromechanical resonators and filters are important signal processing elements. From past decade, there has been tremendous progress for developing new types of microelectromechanical resonators. For these microelectromechanical resonators to find ubiquitous application, it is important that their quality factors and Q values of the system to be maximized. Micromechanical devices are currently one of the key components in communication applications. Transceiver architecture needed Band-pass filters with narrow-bandwidth and low insertion loss. As the compatibility with IC technologies is high and having the small size, MEMS filters can be used as direct on chip replacements. Today, how to develop micromechanical filter with new material and low cost fabrication process is topic of debate. The great advantage of MEMS architecture is driving the research and application of filters.

In this paper, the working of Clamped free beam resonator is studied. When both ends are free then it is known as free free beam resonator and when cantilever like structure is used then it is known as clamped free beam resonator.

II. RELATED WORK

Free free beam flexural mode can have many application and uses. [1] Shows the working of FF beam for the frequency 30 MHz to 90 MHz. Resonators are coupled with the torsional mode support spring. However anchor length kept as quarter of wavelength of impedance. This structure allows achieving high Q for VHF frequency. Device is comprised of a free-free micromechanical beam supported at its flexural node points by four torsional beams. Electrode beneath it is for providing excitation. Torsional support beams strategically designed with quarter wavelength dimension to affect an impedance transformation which isolate FF beam from anchors. Height of dimple is kept such that dc bias voltage can be applied between electrode and resonator. Initial gaps and dimple depth are varied to get frequency from 30-90 MHz.

Working of electrostatically coupled micromechanical beam filter is shown in [2]. High order narrow bandwidth filter is discussed. To eliminate the need of mechanical coupling, electrostatic coupling approach is used. Low frequency single crystal silicon coupled filter have been implemented. Quality factor achieved as 6800 and center frequency is calculated as 170 KHz. Between closely spaced resonators, electrostatic force causes coupling result in high order system. This eliminates the need of any physical coupling. No. of resonator separated with small gaps.

International Journal of Innovative Research in Science, Engineering and Technology

(An ISO 3297: 2007 Certified Organization)

Vol. 3, Issue 1, January 2014

Single silicon is used with transducer gap of 1-3 micrometer. The filter is comprised of two 15micrometer thick, 5 micrometer wide, 500 micrometer long clamped-clamped beam resonators with a 2.8 micrometer wide coupling gap in between them.

Coupling of two free free beam resonator working is shown in [3].It has showed that anchor losses in free free beam resonators are much lesser than that of clamped clamped beam resonators. Supporting beam is located at null vibrating point. That placement helped it for losing less energy through contact. This leads to low anchor loss. As suggested in this paper that more the contacts more will be the loss. Silicon is used to make its substrate while polysilicon is used as a material in beam construction. They found out that quality factor decreases when it operated on high frequency. Filter consisted of two free free beam resonators coupling with at least one torsional beam. At the midpoint of the resonator, electrodes are placed beneath it. In phase and out of phase frequency have the same displacements from the central frequency, two resistors equivalent to damping introduced at the input and output ends, to eliminate the ripples in the passband. Simulation results showed that instead of flexural coupling beams, torsional coupling beams can efficiently excite the in-phase as well as out-of-phase vibration modes.

As mentioned earlier was the free free beam resonator. In other approach, this paper [4] shows the working of fixed fixed beam resonator. Designing of resonator and effects of various parameters on the resonator are discussed in paper [4]. To implement high-Q oscillators, quartz crystals and surface acoustic wave are used. Minimizing the anchor losses is the main issue discussed here. The moving part of the beam is applied by a dc actuation voltage and fixed is applied by an ac signal. The variation in the capacitance is maximum when there is maximum displacement. Current is then amplified by transistor circuit. The resonator is discussed in this paper is working on 10 MHz having Length 40 micrometer, width is equal to 8 micrometer, thickness is equal to 2 micrometer. The gap in between beam and electrode were taken as 0.1 micrometer. Material chose for all these entire geometry is polysilicon. While simulation, it kept in environment of air .The dimensions of the air environment is kept as 100*100*100 micrometer. Simulation is done in COMSOL multiphysics and solid mechanics and electrostatic study is done. The pull in voltage came out to be 5.4V. Eigen value came out to be 9.097 MHz and by calculation, it is came out to be 10.69 MHz. The quality factor comes out to be 10,000.

A counter mode 40MHz RF MEMS resonator is discussed in [5]. The model discussed in the paper enables the tuning. By varying the thickness ratio of the PZT film, effects on the eigen frequency and frequency shift is discussed. The various advantages and disadvantages of the capacitive type and piezoelectric type material resonator behavior is discussed. Mainly the piezoelectric components such quartz crystal resonators are used in architecture to get high quality factor but it come along with the stipulation that exhibit the property of non integration with electronics. It may not allow the development of multiple resonators on single chip. A capacitive microresonator with single crystal silicon structure is used for getting high frequency up to few GHz where piezoelectric RF MEMS resonators are used to get low motional impedances even at high frequency. Aluminum Nitride (AlN) is a piezoelectric material is used for resonator as it is more suitable for high frequency. One disadvantage also mentioned about PZT is that it requires repetitive annealing at temperature more than 600°C. There are two main important approaches for the fabrication of contour mode resonators which are piezoelectric thin films and thin-film Piezoelectric on substrate (TPoS). Amongst them TPoS is discussed here in [5].The FE model of the rectangular contour-mode TPoS resonator is having the length 216 micrometer and width is 100 micrometer. The target frequency was kept as 40MHz.It is found that as the thickness of Si is increases the close circuit frequency also increases and it also affects the frequency shift and it lowers the frequency shift. Also the quality factor reduces as the temperature increases. There is change in the frequency when DC voltage changes from 16V to -16V.the work done in [5] also demonstrates possible tuning techniques which is used to mitigate frequency drift with respect to temperature and thickness variations.

The resonator can be used in frequency reference application as it shown in [6].A quartz crystals material is used here because of its small size and low cost and other key advantages. In this paper [6], the resonator was fabricated using polysilicon and nickel. Nickel was used as electrodeposited material. They approached to use polysilicon or single crystal silicon instead of nickel as it has low acoustic velocity. But still nickel can be used electrodeposited in thick layers. The work in this paper is done in context of motional resistances and beam which is widens near it ends. The beam is anchored from middle and beam ends displaced in opposite directions. AC biased voltage is applied to their respective electrode and DC biased voltage is applied to anchor. At input port, much of the electrical signals are converted into mechanical signals. When nickel beam is used while keeping its length 79 micrometer, then resonance frequency was found to be 28.447 MHz. For polysilicon, they get 27.08 MHz with a beam

International Journal of Innovative Research in Science, Engineering and Technology

(An ISO 3297: 2007 Certified Organization)

Vol. 3, Issue 1, January 2014

of 152 micrometer. Acoustic velocity of polysilicon was found to be almost twice of that of nickel. The motional resistance is reduced by reducing the gap between electrode and resonators. Instead of reducing gaps, increasing width can also be alternate way. The width was considered here is 27 micrometer.

To increase the power handling capacity, a new technique is used in [7], here arrays of resonator were taken in an account. A centered frequency is kept around 10.5 MHz by using the mechanism coupled array design. Second mode free free beam is used in this paper. Its quality factor is greater than 2200 and motional impedance is less than 150 K Ω . An array of 9 resonators has been studied. They found the power handling capacity is greater than that of single resonator. The main advantage they found as the large transduction area effectively reduced the dc-bias voltage by maintaining reasonable motional impedance and high power handling capacity as compare to single resonator. A tiny electrode to resonator gap preferred just for getting low motional resistances. Both the electrodes were placed beneath the resonator. The dc-bias voltage V_P together with ac small signal v_i would induce an ac electrostatic force between the resonator and its driving electrode to excite the resonator. The vibration second mode is discussed. The length of beam taken to be 75 micrometer to get 10 MHz while it is then observed that one could get 100 MHz by keeping he length up to 21.5 micrometer. Keeping electrode to resonator gap as low as possible is not allowed by foundry rule. Thus to compensate this issue, a mechanically coupled resonator array is designed which also helped to lower the motional impedances. Supporting beam kept 3 to get minimum anchor losses. Identical resonators are placed near each other to create a mechanically coupled resonator array. Total 6 anchors were used in array design to preserve enough voltage. When all the resonators operated in same phase then the resonating frequency was same as that of single resonator. But all the structure may have spurious mode thus stiff mechanical coupling half wavelength couplers are used. The resonator array behaves as a single resonator because only a single mode is selected. Increasing the no. of coupled resonators may alter the equivalent mass along with damping constant. Also it changes the stiffness. After simulating they found that the power handling capacity of arrays are more than single resonators.

A fixed fixed beam novel MEMS based resonator is discussed in paper [8]. Simulation is done on Coventor FEM simulator software. Fixed fixed beam was used as it has very low thermal expansion. Frequency response was calculated for the 152micrometer long beam and DC voltage 1.6V is applied. The study of natural frequency for fixed fixed beam structures with different lengths is done.

III. PRINCIPLE

Principle of operation of beam resonator is similar to guitar string. A particular input force is needed to a string to resonate. Its ends are stretched enough to get resonated. For a microelectromechanical resonator, it is needed to apply some voltage to beam. This is provided by the electrodes. Design approach for the electrode and beam design may vary. To get the frequency, it is necessary to study the eigen frequency value. Eigen frequency is totally depending upon the material and geometry of the structure. With respect to length related parameter, its adjustment may lead to its eigen frequency. Frequency is also depends upon scaling. It is very important to get deep knowledge about cantilever. Cantilever is one of the key factors for resonator. As we are going to discuss more about clamped free, the information about cantilever will enable us to get more knowledge. With the similarity to working of guitar, we know that we need to give mechanical force to string to get desired frequency. Same as that, here in resonator, we have to apply some actuation voltage. Filters are also doing the same work as that of guitar but at higher frequency. The material we choose for study are Poly silicon(Poly Si) and Silicon Carbide (SiC). But before that we have studied the cantilever over the material Poly Si, SiC, Aluminium and Nickel. As we needed frequency range for VHF application, Poly Si and SiC were the more efficient amongst them. Eigen frequency for aluminium and nickel were less than that Poly Si and SiC after keeping the same geometry. The cantilever has following geometry:

International Journal of Innovative Research in Science, Engineering and Technology

(An ISO 3297: 2007 Certified Organization)

Vol. 3, Issue 1, January 2014

Length=20μm; Width = 10μm; Height = 1μm

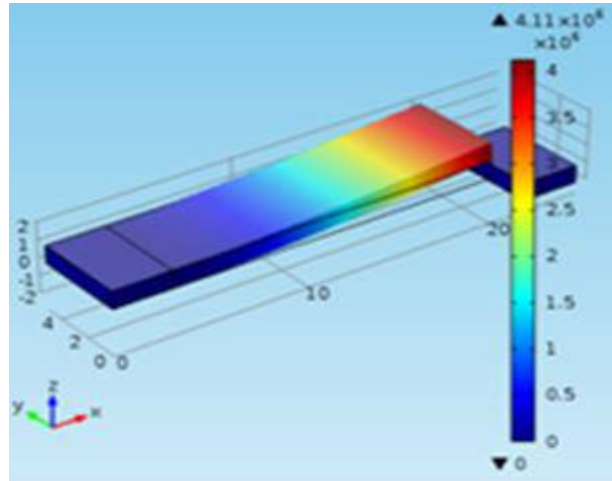

FIG 1: Cantilever

Material SiC Poly Si Ni Al

Frequency 4.83MHz 4.67MHz 2.8MHz 2.9MHz

Table 1: Eigen Frequency of Cantilever for various materials

IV. MODE ANALYSIS

The fundamental frequencies for which a beam can resonate can have different types of modes. Their Eigen frequencies are related with their modes. Mode is nothing but a shape or the different position of an anchor to be placed so that we can get different eigen values. Here for clamped free beam, we have studied the mode shape along with their eigen frequency value. The mode of beam oscillation corresponding to eigen frequency are shown in simulation for different displacement for modes. The displacement shown is prescribed in Y and Z direction. Following is the simulation done by taking in consideration of Poly Si material.

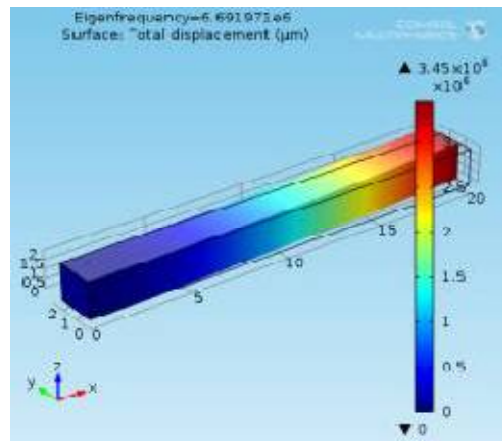

International Journal of Innovative Research in Science, Engineering and Technology

(An ISO 3297: 2007 Certified Organization)

Vol. 3, Issue 1, January 2014

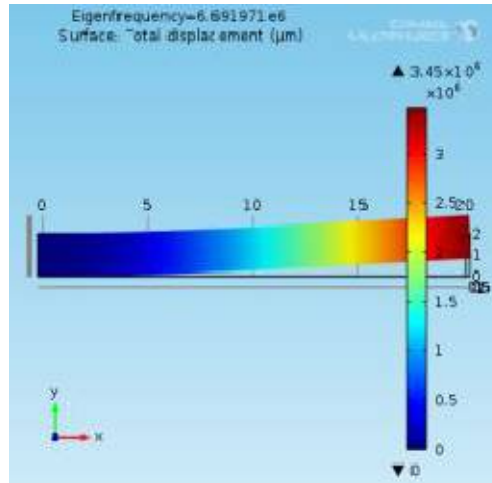

FIG. 2 : Mode 1, prescribed displacement in Y direction with $F_0=6.6919$ MHz

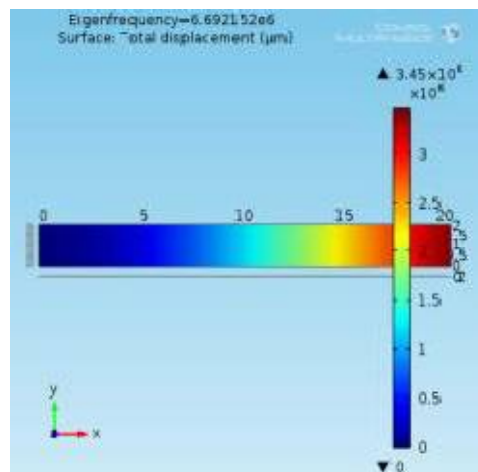
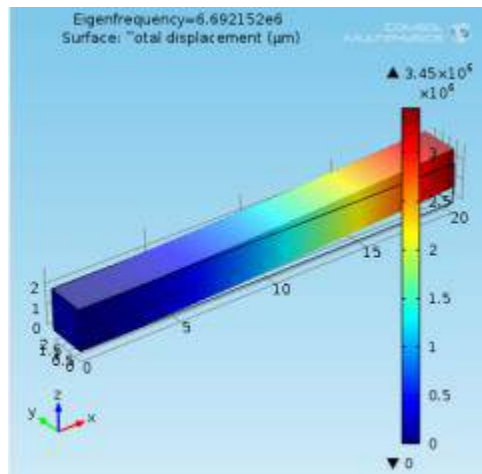

FIG 3: Mode 1, prescribed displacement in Z direction with $F_0=6.6921$ MHz

International Journal of Innovative Research in Science, Engineering and Technology

(An ISO 3297: 2007 Certified Organization)

Vol. 3, Issue 1, January 2014

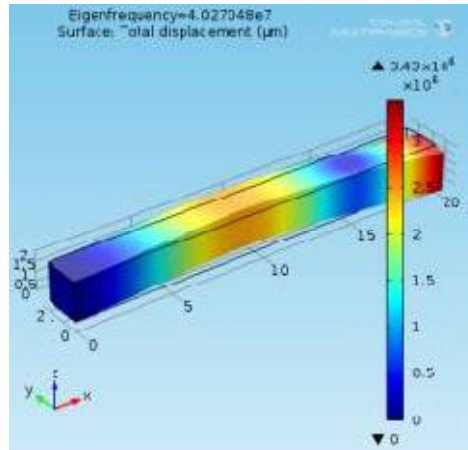

FIG 4: Mode 2, prescribed displacement in Y direction with F0=40.2704 MHz

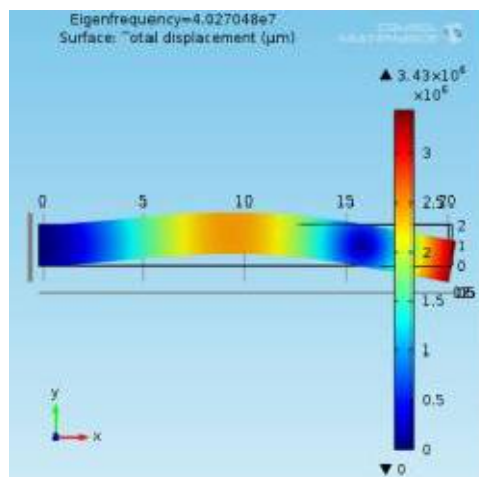

FIG 5: Mode 2, prescribed displacement in Z direction with F0=40.2641 MHz

Here preferably displacement is shown. As we can see there are certain points where displacement is zero and certain points are having displacement is maximum. Preferably this maximum displacement can be seen at the end of the beam. The eigen frequency we get from the free free beam is higher than that of clamped clamped beam. where displacement is zero, we can analyze these points by assuming anchors on it. As for clamped free resonator, it is necessary to study clamped beam. The material we used for the simulation is Poly Si. The material properties are as below.

Table 2: Material properties of Poly Si

The eigen frequency can be calculated with

the help of formula –

$$F0=0.162*(H/L^2)*(E/\rho)^{0.5}$$

For mode 2, it can be calculated as

$$F1=6.27*F0$$

$$F(n)=2.81*F1*(n-0.5)^2$$

Where H is height of the beam which 2 micrometer, L is the length of the beam which 20 micrometer. E is the young's modulus. It is $160*10^9$ Pa. ρ is the density. It is 2320 kg/m³. The calculated frequency obtained for mode 1 is

International Journal of Innovative Research in Science, Engineering and Technology

(An ISO 3297: 2007 Certified Organization)

Vol. 3, Issue 1, January 2014

6.72MHz and frequency calculated for mode 2 is 42.17 MHz. The differences in the frequency calculated and frequency obtained is about 0.4%-3%. It is due to motional resistances and losses.

V. RESONATORS

MEMS resonators are usually used in electronic devices and components thus their mechanical vibrations are needed to be converted into an electrical signal. For that, a transducer is introduced. It used to convert electrical into mechanical signals and vice versa which enables resonator to interface with electronics components. A micromechanical resonator has its own advantages. It is one of the important parts of the filter system. Resonators beam can be of different types depending upon the material used for it and the nodal points where displacement is zero. Severe types of beam construction can be used such as fixed fixed, free free or clamped free etc. Depending on that, its frequency can be verified and can be tuned to desired frequency. One such resonator is discussed in this paper. This resonator is of the “clamped free beam resonator”.

VI. CLAMPED FREE BEAM RESONATOR

Resonator structure depends upon the electrode and the beam type whether it is clamped or free at its ends. The resonator we are going to discuss is “Clamped Free Beam” resonator. As shown in the fig.6. One of its ends is clamped and other is made free. 2 electrodes are placed by which one of beam is surrounded. One of these electrodes is used as excitation electrode actuation electrode and other is sense electrode. The electrostatic voltage allows the beam to bend and beam will oscillate. The boundary conditions are given around it. Air as dielectric is added. The properties of Air are as follows.

Property	Name	Value	Unit
Relative permittivity	epsilon _r	1	1
Relative permeability	mu _r	1	1
Dynamic viscosity	mu	eta(T[1/...	Pa·s
Ratio of specific heats	gamma	1.4	1
Electrical conductivity	sigma	0[S/m]	S/m
Heat capacity at constant pres...	C _p	C _p (T[1/K...	J/(kg·K)
Density	rho	rho(pA[1...	kg/m ³

Table 3: Material properties of Air

The resonator structure can be given as:

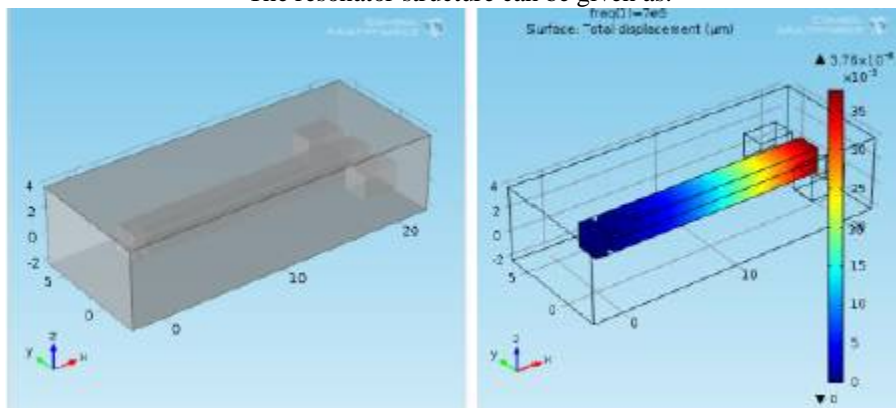

FIG 6: Clamped free resonator

International Journal of Innovative Research in Science, Engineering and Technology

(An ISO 3297: 2007 Certified Organization)

Vol. 3, Issue 1, January 2014

VI. RESULT

In clamped free resonator, the frequency obtained after simulation is 7.412 MHz. The dimension kept for the beam is $20\mu\text{m} \times 2\mu\text{m} \times 2\mu\text{m}$. along with that, electrode dimensions kept as $1\mu\text{m} \times 2\mu\text{m} \times 2\mu\text{m}$. Gap between electrode and beam is $0.5\mu\text{m}$. One can also achieve higher frequency with the help of free free beam approach.

REFERENCES

- [1] Kun Wang, Ark-Chew Wong and Clark T.-C. Nguyen "VHF Free-Free Beam High-Q Micromechanical Resonators" published in journal of microelectromechanical systems, vol. 9, no. 3, September 2000.
- [2] Pourkamali, Reza Abdolvand, Gavin K. Ho and Favrokh Ayuzi School of Electrical and Computer Engineering Georgia Institute of Technology, Atlanta "Electrostatically Coupled Micromechanical Beam Filter" published in IEEE conference on MEMS 2004.
- [3] C.J. Li and S. K. Lin Herman Sahota, Taiwan "High Q VHF Micromechanical Filters Using Free Free Beam Resonators" published in IEEE conference on Magnetics 2014.
- [4] Vivek Harshey, Amol Morankar, and Dr. R.M. Patrikar VNIT Nagpur India "MEMS Resonator for RF Applications" published in COMSOL conference, Bangalore in 2011.
- [5] Russell Farrugia, Ivan Grech, Owen Casha, Joseph Micallef and Edward Gatt, University of Malta Msida, Malta "Performance Analysis of an RF MEMS TPoS Resonator using FE Modelling" Published in 2015 Symposium on Design Test Integration and Packaging of MEMS and MOEMS.
- [6] Ritesh Ray Chaudhuri, Tarun Kanti Bhattacharyya, Indian Institute of Technology, Kharagpur Kharagpur, India "Microelectromechanical Longitudinal Beam Resonator for Frequency Reference Applications" published in 2013 26th International Conference on VLSI Design and the 12th International Conference on Embedded Systems
- [7] Ming-Huang Li, Wen-Chien Chen, and Sheng-Shian Li "Mechanically Coupled CMOS-MEMS Free-Free Beam Resonator Arrays With Enhanced Power Handling Capability" published in IEEE transactions on ultrasonics, ferroelectrics, and frequency control, vol. 59, no. 3, march 2012.
- [8] H. Goktas, and M.E. Zaghoul, The George Washington University, Washington "CMOS-MEMS Novel Resonator for Filter Tuning" published in IEEE 58th International Midwest Symposium on Circuits and Systems (MWSCAS), 2015