

# Focus On Higher Engine Durability with Optimised Mechanical Development for 2 Cyl Gasoline Engine

M Ramesh

M Tech, Department of I C Engines, Vel Tech Rangarajan Dr. Sagunthala R&D Institute of Science And Technology  
Avadi, Chennai, India

**ABSTRACT:** Customer satisfaction is one of the key factors for success of any product in the market. Typically Customers who purchases a new passenger look for the following features,

- (1) High Fuel efficiency
- (2) More life i.e High durability of the components
- (3) Less maintenance i.e less service turn around
- (4) Less NVH (Noise, Vibration and Harshness), Present day customers are more irritant to noise and vibration.

In order to achieve above features inherently, a better Product development from the design to production stage is essential. All key parameters that influence the Product performance should be focussed on the all stages of Product development. This project work will essentially discuss on the mechanical development aspect of an engine, which mainly constitutes durability and reliability of the engine.

Engine oil consumption is an important source of hydrocarbon and particulate emissions in automotive engines. Oil evaporating from the piston-ring-liner system is believed to contribute significantly to total oil consumption, especially during severe operating conditions. As a part of the effort to comply with increasingly stringent emission standards, engine manufacturers strive to work on EMS calibration strategies. This requires the advancement of the understanding of the characteristics and driving mechanisms of various applications.

This paper will discuss certain parameters of the below critical areas on a two cylinder gasoline engine,

- (1) Protection on Engine to have oil consumption
- (2) Protection on Engine to avoid overheating
- (3) Engine Calibration

## I. INTRODUCTION

### A. MECHANICAL DEVELOPMENT

Many different types of engine tests are performed within the industry, some more common than others. The six principal tests and relevant applications are listed as follows:

- a. Durability (Design Validation Test)
  - i. Steady load and speed operation
  - ii. Load cycling
  - iii. Speed cycling

- iv. Thermal shock cycling
- v. Component development
- vi. Vehicle cycle simulation
- b. Performance
  - i. Power curves
  - ii. Governor curves
  - iii. Lubrication oil consumption
  - iv. Flow measurements
  - v. Heat balance
  - vi. Emissions measurements
- c. Lubricants and Fuels
  - i. Automotive lubricants
  - ii. Marine lubricants
  - iii. Black sludge formation
  - iv. Intake valve deposits
  - v. Combustion chamber deposits
- d. Specialized Investigations and Testing
  - i. Rig testing (e.g., bearings, antifreeze, erosion)
  - ii. Simulated or environmental testing
  - iii. Photo elastic stress measurements
  - iv. Strain gauge testing
  - v. Flywheel burst testing
- e. Exhaust System Testing
  - i. Vehicle cycle simulation
  - ii. Steady state
- f. Catalyst Ageing
  - i. Vehicle cycle simulation
  - ii. Steady state
  - iii. Accelerated ageing
  - iv. Light-off efficiency tests
  - v. Sulfate release tests

Of course, there are other specific test types, but the preceding list covers the vast majority of test types that are likely to be encountered in the day-to-day testing undertaken by the research student, automotive engineer, and engine test technician.

Fully transient tests and, indeed, automatic mapping software programs are disciplines worthy of additional study. However, to glean the maximum useful repeatable data from all forms of transient testing, it is essential to have a full understanding of and experience with steady-state test types. Mathematical modeling of engine functions is an essential element in the design and development of new engine types. The accurate cross-correlation of modeled data with actual running data enables the leading manufacturers to move ahead of the opposition rapidly and to obtain clear market gains.

**B. DEFINITIONS**

The popular terms "durability" and "reliability" often are confused. Therefore, before discussing durability tests in depth, it is necessary to define the correct meaning of each term.

**Reliability**-The capability of an item to perform a prescribed task under defined conditions for a predetermined period of time.

**Durability**-The capacity of an item to reach a designed life

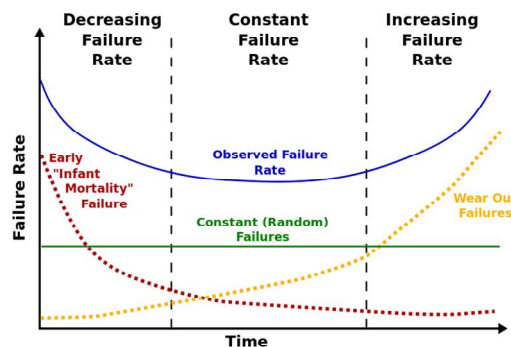

Figure Fig 1 : The Bathtub curve (Richard D. Atkins, 2009)

**C. INCREASING THE SEVERITY OF THE TEST**

Some manufacturers increase the severity of their tests by including test conditions that are more severe than those encountered in normal service. These may include overfueling, over-speed, advanced timing to increase cylinder pressure, extreme ambient conditions, and so forth. These tests are of value in reducing the time required to complete the test series, increasing the confidence level in the results when related to normal service, or a combination of both. However, the specification of such tests requires extreme care and normally can be achieved only by reference to historical data. It is a simple matter to specify tests of extreme severity that lead to early failure and therefore cannot be related to normal service. Development on this basis results in the engine being grossly over-designed for its intended application and hence is non-competitive. Early in a new engine program, at least two durability tests of 1000-hours duration should be undertaken. The objective of this work is to demonstrate that no major deficiencies are present in the design of the revised engine. Classical statistical analysis states that for tests carried out,

$$CL = 1 - R^N$$

where,

CL = confidence level

R = reliability

N = number of tests completed without failure

From this, it can be seen that to demonstrate a reliability of 90% with a confidence level of 90%, a total of 22 tests is required. For the same reliability, one test gives a confidence level of 10%, while two tests increase this level to 19%.

Therefore, it is clear that a statistical determination of reliability cannot be made from one or two tests with any reasonable degree of confidence.

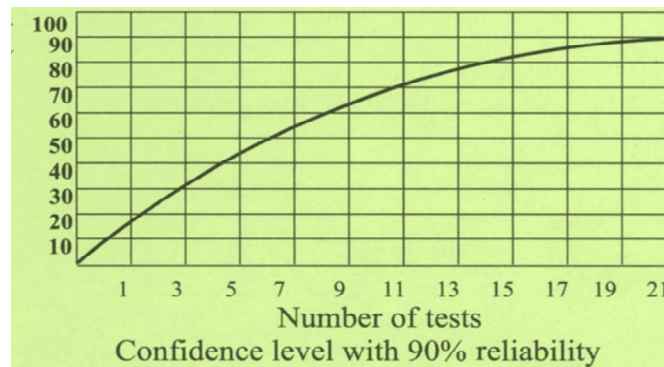

Fig 2 : Confidence with 90% reliability (Richard D. Atkins, 2009)

When specifying the duration of durability tests, three aspects must be considered:

- Verification that wear will not prevent the expected service life from being achieved
- Verification that failure due to mechanical fatigue will not occur
- Verification that failure due to thermal fatigue will not occur

## II. PROBLEM DESCRIPTION

### A. SEVERITY OF ENGINE OIL CONSUMPTION

As per European norms, consumption of Engine oil more than 0.5% that of Fuel consumption is considered as High Engine oil consumption. Indian OEMs consider consumption is high when the oil level goes below the minimum mark on the oil level dipstick. Typically, the difference in oil quantity between maximum and minimum oil level would be 600ml and average oil change interval for Indian roads is assumed at 10,000 kms which is 0.06 ml/km and any consumption above this quantity is considered as High Engine Oil Consumption. When more engine oil is consumed per km, engine would starve without lubrication, parts in contact without oil wearing out faster and seizure of components.

Factors that affect Engine Oil consumption are listed below and it is observed that engine oil can either be leaked out of the engine or burnt inside combustion chamber or oil getting sucked into the intake manifold with closed circuit for oil separation from blow-by gases.

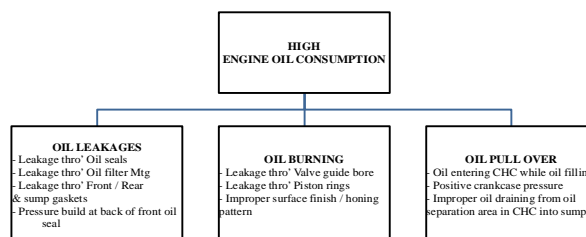

Fig 3: Causes for High engine oil consumption

## B. SEVERITY OF ENGINE OVERHEATING

The primary purpose of the engine cooling system is to remove the heat absorbed by the engine assembly as a result of the combustion process, as well as friction heat generated within the engine assembly as components move against each other at high speeds.

The peak burned gas temperature in the cylinder of an internal combustion engine is of order 2500 K. Maximum metal temperatures for the inside of the combustion chamber space are limited to much lower values by a number of considerations, and cooling for the cylinder head, cylinder, and piston must therefore be provided. These conditions lead to heat fluxes to the chamber walls that can reach as high as 10 MW/m<sup>2</sup> during the combustion period. However, during other parts of the operating cycle, the heat flux is essentially zero. The flux varies substantially with location: regions of the chamber that are contacted by rapidly moving high-temperature burned gases generally experience the highest fluxes. In regions of high heat flux, thermal stresses must be kept below levels that would cause fatigue cracking (so temperatures must be less than about 400<sup>0</sup>C for cast iron and 300<sup>0</sup>C for aluminum alloys). The gas-side surface of the cylinder wall must be kept below about 180<sup>0</sup>C to prevent deterioration of the lubricating oil film. Solving these engine heat-transfer problems is obviously a major design task. Major modes of heat transfer seen in cooling system are conduction, convection and radiation.

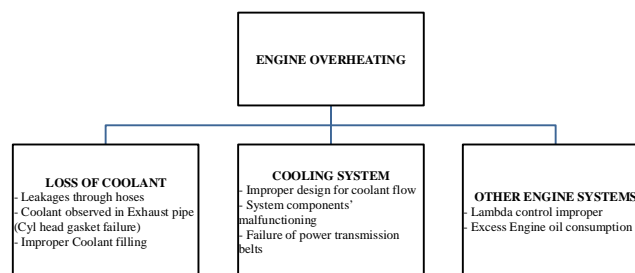

Fig 4 : Causes for Engine overheating

## C. SEVERITY OF ENGINE CALIBRATION

When examining the historical development of car engines, two trends can be observed. On the one hand, engine performance has continuously increased, while on the other – due to the demands of emission-control legislation – the emission of harmful pollutants has gradually decreased. The simultaneous pursuit of these two development objectives has only been possible by virtue of an enormous degree of system control on the engine.

It is therefore no longer sufficient, as was once the case, to control only fuel-injection and ignition components. Gasoline engines with the full range of technology currently available are equipped with a large number of supplementary systems such as exhaust-gas recirculation or evaporative-emissions control or limp-home mode. In future, other systems, such as variable valve timing, that are not as widely used at present due to cost considerations, will become increasingly widespread. The components of all these systems have to be controlled so as to achieve optimum engine operation under all conceivable conditions. Gasoline engines with direct fuel injection pose particularly demanding requirements in this regard. Consequently, complex electronic systems are indispensable for the management of gasoline engines. With the startlingly rapid progress in semiconductor technology, electronic control units have become more and more powerful so that complete gasoline- engine management systems.

A limp-home mode protects the engine from engine overheating due to various reasons and brings the vehicle limp-home condition. There are various Calibration strategies that are being followed by OEMs to bring the vehicle to this mode. This paper will explain a cost effective, simple strategy that will keep the engine and hence the vehicles safe under severe operating conditions and protect through limp-home operation.

III. METHODOLOGY / EXPERIMENTAL SET-UP

A. METHODOLOGY – PROCESS FOR DETERMINING ENGINE OIL CONSUMPTION

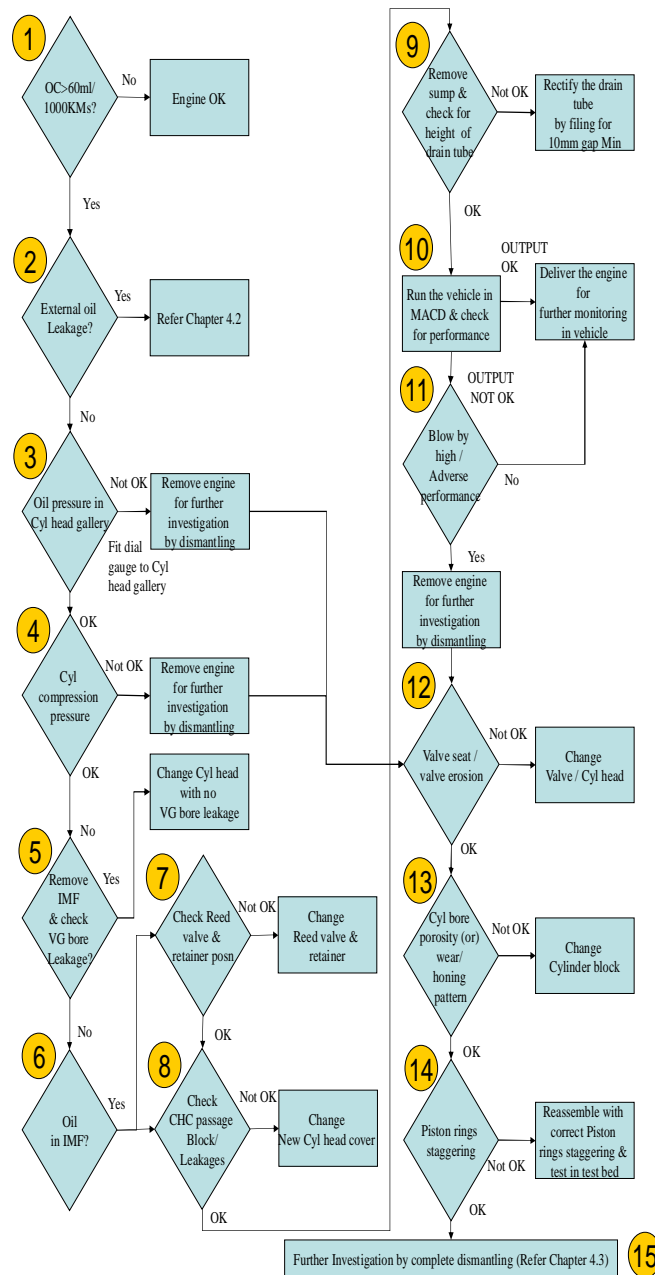

Fig 5 : Process for determining Engine oil consumption

**B. METHODOLOGY – PROCESS FOR DETERMINING EXTERNAL OIL LEAKAGE**

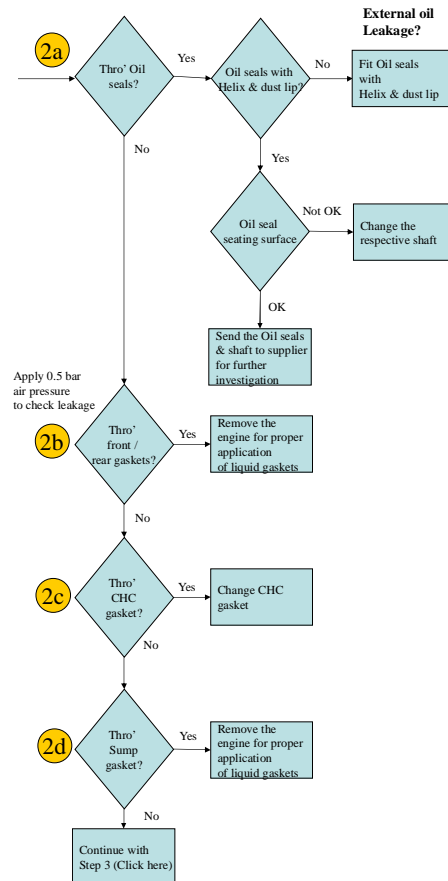

Fig 6: Process for determining External oil leakages

**C. METHODOLOGY – PROCESS FOR INVESTIGATION ON ENGINE LEVEL BY DISMANTLING**

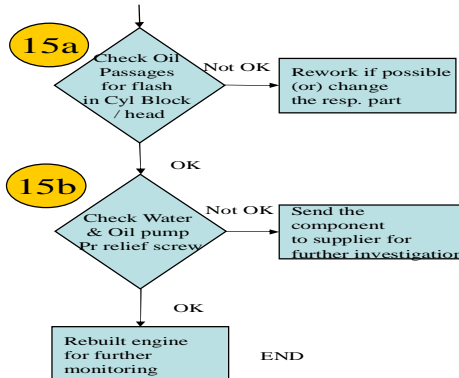

Fig 7 : Process for investigation on engine level by dismantling

#### IV. DISCUSSION OF THE PROPOSED WORK

##### A. STUDY ON PRESENT DESIGN AND POSSIBILITY OF IMPROVEMENTS

**Oil leakage:** As we have seen, Oil leakage is one of the reasons for engine oil consumption, we will try to look into certain design features of engine components which are prone to oil leakage. Oil seals and mounting surface  
Oil leakage from Front & Rear crank oil seals can be due to high circumferential speed of crankshaft when oil is being pushed out through the seals. Also, environmental dust is able to reach the sealing area, damaging shaft / seal and consequently leading to oil leakage.

On closer perspective, Crankshaft oil seating surface with grind tool marks leads to threading action & hence leading to oil leakage through the threading path traced by the oil during the rotation of crankshaft.

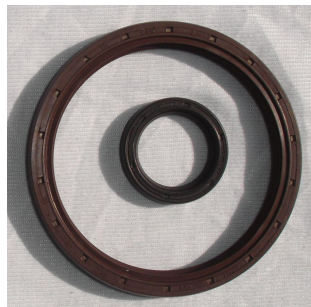

Fig 8: Oil seal without dust lip and helix

Oil filter mounting surface

Oil leakage through Oil filter & Cylinder block mounting face due to eccentricity of the adaptor used for Oil filter mounting on the block which leads to improper oil seal (in the oil filter) seating on the groove in oil filter.

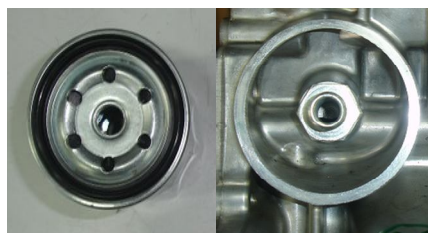

Fig 9 : Oil filter mounting

Oil leakage through gaskets

Oil leakage from paper gaskets of Front / Rear cover and leakage from cork gasket of Sump.

Pressure build behind Front oil seal

Pressure build at back of front oil seal due to less area available, between the oil seal & oil pump rotor, for the oil to drain from the Front oil seal lip



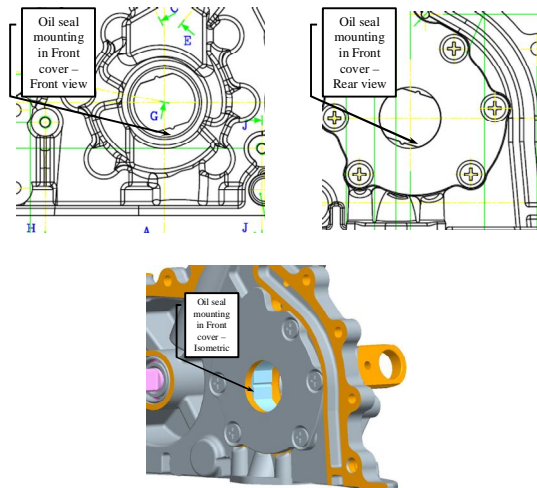

Fig 10: Oil seal mounting location

| Speed (RPM) | Present Configuration<br>R1 Slot / $\Phi$ 32 Backplate |                    |                                 |
|-------------|--|--------------------|---------------------------------|
|             | Oil temperature (Deg C)                                | Oil pressure (bar) | Pressure behind oil seal (mbar) |
| Idle        | 106.1  | 3.4                | 0                               |
| 1500        | 99.8   | 3.8                | 0                               |
| 2000        | 98.3   | 3.8                | 0                               |
| 2500        | 97.4   | 4.1                | 0                               |
| 3000        | 96.9   | 4.4                | 0                               |
| 3500        | 96.8   | 4.5                | 0                               |
| 4000        | 99.1   | 4.6                | 15                              |
| 4500        | 101.8  | 4.6                | 25                              |
| 5000        | 105.1  | 4.6                | 32                              |
| 5500        | 112  | 4.5                | 47                              |
| 5500        | 120  | 4.3                | 47                              |

Table 1 : Pressure behind Front Oil seal

**Oil Burning:** As explained earlier, the next irritant cause for oil consumption is oil burning in combustion chamber by either oil leaking through the valve guide seals or escaping through the piston rings during downward stroke of the piston.

Oil leakage through Valve guide parent bore & cylinder head, getting burnt in combustion chamber

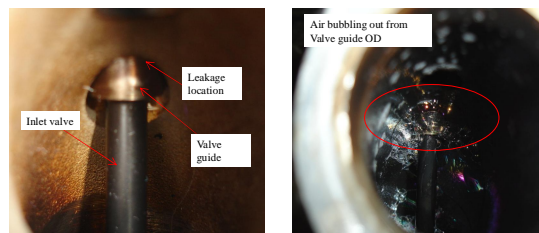

Fig 11: Gap between Valve guide and its bore in Cylinder head leading to leakage

Leakage through Piston rings, piston has three rings configuration with 3 piece oil ring

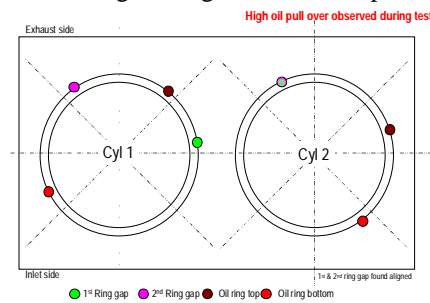

Fig 13: Schematic representation: Durability test Sample 1 - Rings position while dismantling

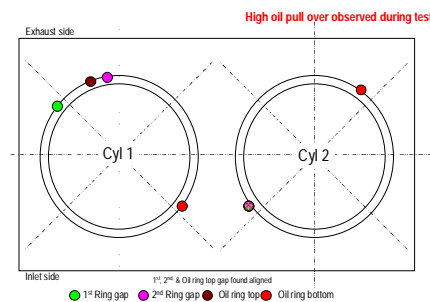

Fig 14 : Schematic representation: Durability test Sample 2 - Rings position while dismantling

**Oil pull over:** It was observed through a transparent cylinder head cover that oil enters into cylinder head cover oil separation area, which is connected to Inlet manifold whose intended purpose is to supply air after separating oil from the blow-by gases. But due to the collection of pool of oil in vicinity of the U tube, attached to the baffle plate of oil separator, during oil filling at the time of Engine servicing, the oil gets sucked into Inlet manifold immediately after starting the engine. Hole size in Cyl head cover baffle is  $\Phi 26\text{mm}$  as per present design

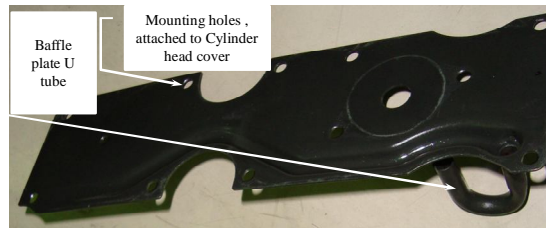

Fig 15 : Baffle plate U tube

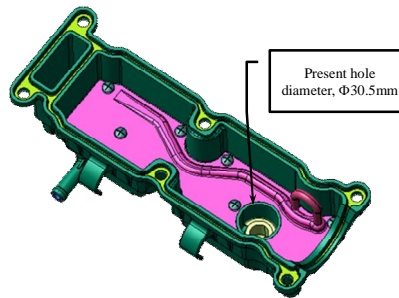

Fig 16: Baffle plate in assembled condition with Cylinder head cover

Certain measurements with various configurations for Blow-by and Crankcase ventilation circuit carried out to understand the effect of Oil-pull over

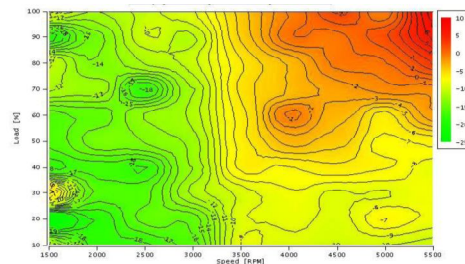

Fig 17: Blow-by open to atmosphere with external Oil separator in circuit

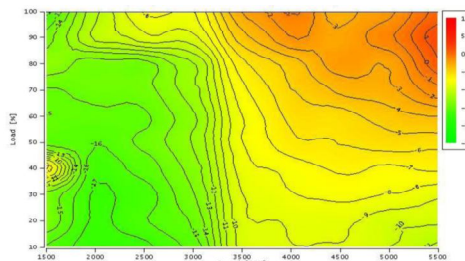

Fig 18: Blow-by recirculated to Inlet manifold with external Oil separator in circuit

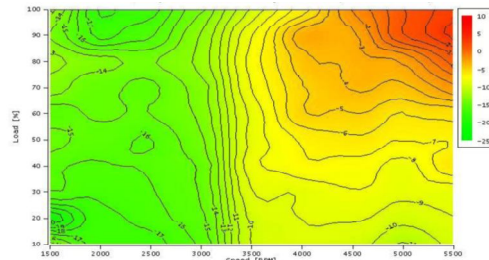

Fig 19 : Blow-by recirculate to Inlet manifold without external Oil separator in circuit

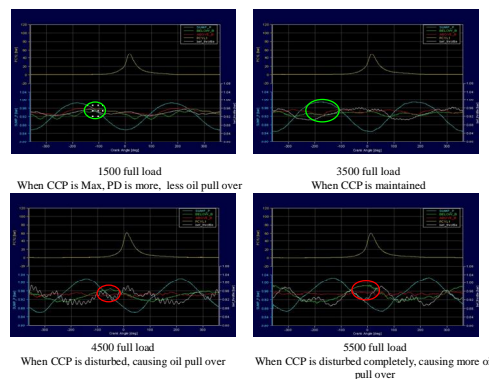

Fig 20 : Crankcase pressure measurement every crank angle along with  $p\theta$  and sump pressure

#### IV. SUGGESTIONS ON DESIGN OF ENGINE COMPONENTS BASED ON THE OBSERVATION IN ENGINE FUNCTIONAL AND DURABILITY TESTING

Various design modifications are suggested based on the observations on Functional and Durability testing of Engine. These design modifications have already been reviewed by the Design committee and approved. Based on the approval, new proto parts have been ordered. These proto parts will be fitted in Engine to verify the design, as per Design Validation plan plotted for each of these components. The components will be tested through Functional and Durability tests and will released for series production.

| Sl No | Failure observed              | Design modification / Change in operation suggested  | Testing Methodology to verify the New design |
|-------|-------------------------------|--|--|
| 1     | Oil leakage through Oil seals | <ul style="list-style-type: none"> <li>i. Oil seals with Dust lip &amp; helix fitted to avoid the leakage thro' seals</li> <li>ii. crankshaft plunge grinding operation introduced in production process</li> <li>iii. plastic protective covers provided to avoid handling damages, scratch marks during transit</li> </ul> | Durability testing                           |
| 2     | Oil leakage through           | <ul style="list-style-type: none"> <li>i. Oil filter seal seating area on the Cyl block increased from 4mm to 7.5mm to take care of the eccentricity of the adaptor</li> </ul>   | Functional and Durability                    |

|   |                                      |   |                                   |
|---|--------------------------------------|---|-----------------------------------|
|   | Oil filter mounting                  | i. Oil filter changed from 6 holes to 8 holes to take care of pressure difference<br>ii. Oil filter changed from 6 holes to 8 holes to take care of pressure difference   | testing                           |
| 3 | Oil leakage through gaskets          | i. liquid gasket Loctite 5182 (anaerobic sealant) applied for Front & Rear cover<br>ii. liquid gasket Loctite 5060 (RTV sealant) applied for Sump gasket  | Functional and Durability testing |
| 4 | Pressure build behind Front oil seal | i. Various configurations for slot radius (R5) and back plate diameter ( $\Phi$ 35mm) have been ordered to Front cover supplier   | Functional and Durability testing |
| 5 | Oil leakage through Valve guide bore | i. Cylinder head impregnation to remove the vacuum present between the valve guide parent bore & cylinder head is introduced. Samples after this corrective action to be received from Cylinder head supplier for further testing and validation  | Functional and Durability testing |
| 6 | Leakage through Piston rings         | i. Piston ring staggering operation introduced in Engine assembly<br>ii. Cylinder distortion, to be studied with Cylinder head torque in place, which causes improper Piston rings rotation along the Cylinder bore axis and hence creating ring gap alignment to cause oil sucking into combustion chamber | Functional and Durability testing |
| 7 | Oil pull over                        | i. Hole size in Cyl head cover baffle reduced to $\Phi$ 9mm from $\Phi$ 30.5mm<br>ii. Cyl head cover inlet hole size to be optimized for better ventilation<br>iii. Inlet hole size of Clean air hose & the location to be optimized  | Functional and Durability testing |

Table 2 : Summary of Corrective action for Oil consumption

## V. CONCLUSIONS

The influence of various parameters for High Engine oil consumption is studied and based on benchmark and experience, corrective actions have been suggested. All the Design modifications suggested was approved by the committee. Proprietor drawings are modified and design modification in supplier drawings are released and advised respectively to supplier for proto component manufacturing. A lead time of 2 to 3 weeks will be needed for proto parts receipt. Engine testing is planned after the component receipt. All these components will be monitored for its performance and drawings to series production will be released.

## REFERENCES

1. Armin Frommer, Annette Beeckmann, Rudolf Freier, Reiner Künzel " *Analysis of Lube Oil Consumption in Transient Engine Operation*" MTZ January 2013, Volume 74.
2. Ertan Yilmaz, Tian Tian, Victor W. Wong and John B. Heywood Sloan Automotive Laboratory, Massachusetts Institute of Technology " *An Experimental and Theoretical Study of the Contribution of Oil Evaporation to Oil Consumption*" SAE Paper 2002-01-2684, 0148-7191.
3. Ertan Yilmaz, Tian Tian, Victor W. Wong and John B. Heywood Sloan Automotive Laboratory, Massachusetts Institute of Technology " *The Contribution of Different Oil Consumption Sources to Total Oil Consumption in a Spark Ignition Engine*", SAE Paper 2004-01-2909, 0148-7191.

**5<sup>th</sup> International Conference in Magna on Emerging Engineering Trends 2015 [ICMEET 2015]**

**On 27<sup>th</sup> & 28<sup>th</sup> February, 2015**

**Organized by**

**Department of Mechanical Engineering, Magna College of Engineering, Chennai-600055, India.**

4. Hartmut Sauter, Detlef Mathiak, Jan Müller, Stephan List " Crankcase Ventilation –Inline Measurements of Oil Aerosols" MTZ February 2012, Volume 73.
5. Colin R Ferguson, Allan T. Kirkpatrick" *Internal Combustion engines Applied Thermosciences*" 2011, 978-81-265-3007-6, 334–365.
6. Ganesan. V" *Internal Combustion Engines*" 2012, 978-1-25-900619-7, 457–594.
7. Heinz Heisler" *Advanced Engine Technology*" Volume 8, 2008, 978-0-340-56822-4, 717 - 757.
8. John B Heywood" *Internal-Combustion-Engines-Fundamentals* 2013, 0-07-028637, 668 - 711.
9. Julian Happian-Smith" *An Introduction to Modern Vehicle Design*", 2008, 07506-5044-3, 80-112.
10. Martyr. A. J, M.A. Plint" *Engine Testing*" *Sensors* 2007, 978-0-7506-8439-2, 46-157.
11. Pundir. B. P " *Internal Combustion Engines Combustion and Emissions*" 2010, 978-81-8487-087-9, 109–476.
12. Richard D. Atkins" *An Introduction to Engine Testing and Development*", 41 (2008) 978-0-7680-2099-1, 77-99.
13. Zhao. F, M.-C. Lai, D.L. Harrington" *Automotive Spark-ignited Direct-injection gasoline engines*" 1999, 0360-1285, 532-552.