

Modelling and Analysis of Automotive Wheel Rim

Manugonda Babu¹, Dr. V.S. Hariharan²P.G. Student, Department of Mechanical Engineering, Balaji Institute of Engineering & Sciences, Telangana, India¹Professor, Department of Mechanical Engineering, Balaji Institute of Engineering & Sciences, Telangana, India²

ABSTRACT: The purpose of the automotive wheel rim provider's a firm base on that to suit the tire. Its dimensions, shape should be appropriate to adequately accommodate the actual tire needed for the vehicle. During this study a tire of Automotive wheel rim belonging to the disc wheel category is taken into account. Style in a crucial industrial activity that influences the standard of the product. The wheel rim is intended by victimization modeling software CATIAV5R20. In modeling the time spent in manufacturing the advanced 3-D models and therefore the risk concerned in style and producing method may be simply decreased. That the modeling of the wheel rim is created by victimization CATIA. Later this CATIA model is imported to ANSYS for analysis work. ANSYS software is that the latest used for simulating the various forces engaged on the part and also for conniving and viewing the results. A problem solver Mode in ANSYS software calculates the deformations, stresses, strains, weight, while not manual interventions, Reduces the time compared with the tactic of mathematical calculations by a person's. ANSYS static analysis work is Administered by considered completely different materials particularly kelver49, Al and carbon fiber and their relative Performances are determined severally. Additionally to the present rim is subjected to fatigue (static structural ansys), a part of structural analysis is administered its performance is determined. During this paper by observing the results of each static and fatigue analysis obtained and material is recommended as best material and weight Comparison is completed by analysis software 15.0.

KEYWORDS: Wheel rim, Catia, fatigue analysis, and structural analysis, automotive wheel rim etc

I. INTRODUCTION

Several thousand years ago was the beginning of the history of wheel once the civilization began to use the log to move heavy objects. The initial of the wheel were the round slices of a log and it absolutely was step by step re-in forced and employed in this manner for hundreds of years on both carts and wagons. This solid disc modified to a style having many spokes radially organized to support the outer part of the wheel keeping it equal from the wheel centre. A picket wheel that used hard wood stakes as spokes was very fashionable as a wheel for several vehicles up to concerning 1920 Most steel truck rims are created within the same manner. It starts with a tough solid hub, with 4, 5 or maybe 6 holes for the bolts. A spun steel rim is then secured around this with as Erie of welds. The rim is correctly balanced so given a sleek end. Though some steel rims are on the market in silver and chrome, most of these finishes are saved for alloy wheels. Truck wheels have to be compelled to be sturdy and ready to carry around weight you will not realize several spoke styles with these rims. They are sometimes as solid as potential .however that does not mean your choices are not varied once craving for replacements. The foremost vital issue to recollect is to get a similar size rims you are exchange unless you are additionally coming up with on vehicle modifications. Lighter wheels will improve handling by reducing UN sprung mass, permitting suspension to follow the terrain additional closely and so improve grip, but not all alloy wheels are lighter than their steel equivalents. Reduction in overall vehicle mass may also facilitate to cutback fuel consumption. Better heat conductivity will facilitate dissipate heat from the brakes, that improves braking performance in additional stringent driven conditions and reduces the possibility of equipment failure attributable to overheating.

International Journal of Innovative Research in Science, Engineering and Technology

(An ISO 3297: 2007 Certified Organization)

Vol. 5, Issue 4, April 2016

1.1 Type of Wheel/Rim (Material):

- (1) Wire Spoke Wheel
- (2) Steel Disc Wheel
- (3) Light Alloy Wheel
 - A) Aluminum Alloy Wheel
 - B) Magnesium Alloy Wheel
 - C) Titanium Alloy Wheel
 - D) Composite Material Wheel

II. RELATED WORK

A wheel rim is a highly stressed component in an automobile that is subjected to bending and torsional loads. Because of the long life and high stresses, as well as the need for weight reduction, material and manufacturing process selection is important in rim design. There are competitions among materials and manufacturing processes, due to cost performance, and weight. This is a direct result of industry demand for components that are lighter, to increase efficiency, and cheaper to produce, while at the same time maintaining fatigue strength and other functional requirements.

A paper published in the year 2009, which is about the fatigue analysis of aluminium wheel rim by Liangmo Wang - Yufa Chen - Chenzhi Wang - Qingzheng Wang School of Mechanical Engineering, Nanjing University of Science & Technology, China.

To improve the quality of aluminium wheels, a new method for evaluating the fatigue life of aluminium wheels is proposed in that paper. The CATIA and ANSYS software was used to build the static load finite element model of aluminium wheels for rotary fatigue test. Using the method proposed in this paper, the wheel life cycle was improved to over 1.0×10^5 and satisfied the design requirement. The results indicated that the proposed method of integrating finite element analysis and nominal stress method was a good and efficient method to predict the fatigue life of aluminium wheels.

In this paper, for predicting the wheel fatigue life, the nominal stress method was integrated into the CAD / CAE technology to simulate the rotary fatigue test. In addition, an actual prototype of the test was done to verify the analysis.

Designing software:

The Modern world of design, development, manufacturing so on, in which we have stepped can't be imagined without interference of computer. The usage of computer is such that, they have become an integral part of these fields. In the world market now the competition is not only cost factor but also quality, consistency, availability, packing, stocking, delivery etc. So are the requirements forcing industries to adopt modern technique rather than local forcing the industries to adapt better techniques like CAD / CAM / CAE, etc. The Possible basic way to industries is to have high quality products at low costs is by using the computer Aided Engineering (CAE), Computer Aided Design (CAD) And Computer Aided Manufacturing (CAM) set up. Further many tools is been introduced to simplify & serve the requirement CATIA

Figures shows designing of a wheel rim, **Fig -1:** sketch used for making rim, **Fig -2:** showing wheel rim, **Fig -3:** Drafted sheet for wheel rim, **Fig -4:** Sectional view of wheel rim.

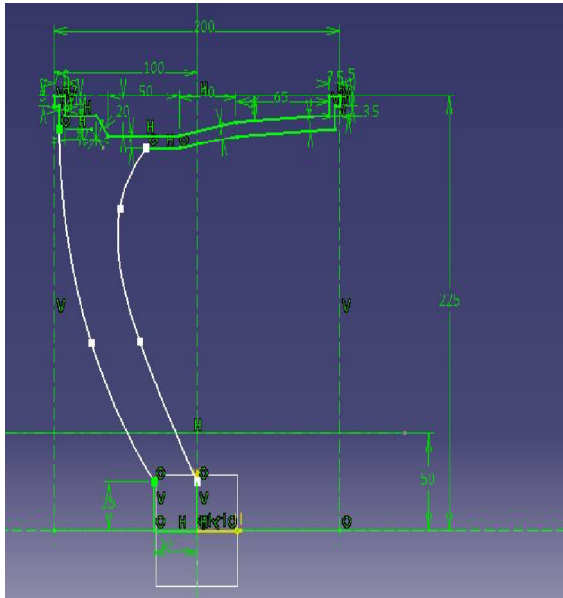

Fig -1: sketch used for making rim

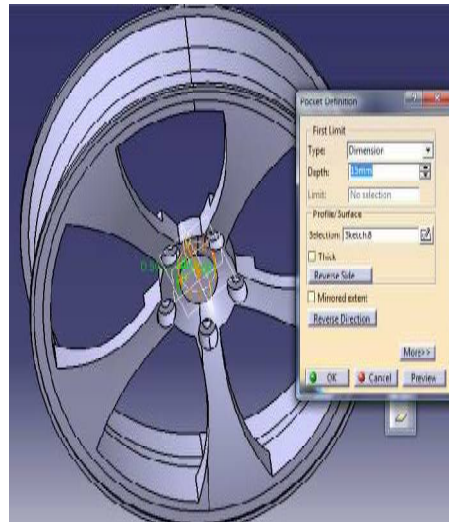

Fig -2: showing wheel rim

The above figures shows moulding wheel rim in CATIA

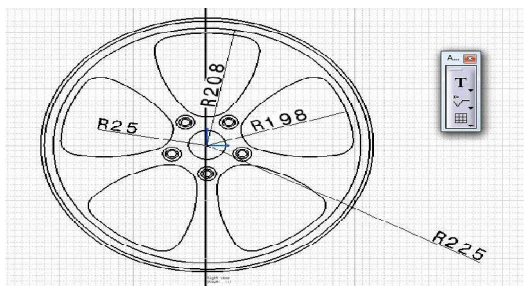

Fig 3: Drafted sheet for wheel rim

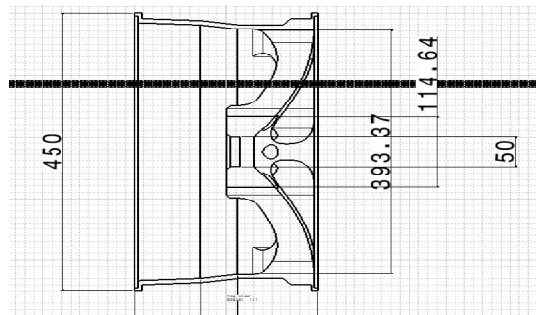

Fig -4: Sectional view of wheel rim.

FEM:

The finite element technique could be a powerful tool for the numerical procedure to get solutions to several of the Issues encountered in engineering analysis. Structural, thermal and heat transfer, fluid dynamics, fatigue connected issues, electrical and magnetic fields, the ideas of finite element ways are often used to resolve these engineering issues. during this technique of study, a complex region process a time is discredited into straightforward geometric shapes referred to as finite components the domain over that the analysis is studied is split into variety of finite components. The material properties and also the governing relationship are thought of over these components and expressed in terms of unknown values at component corner. An assembly method, punctually considering the loading and constraint, ends up in set of equation. Solution of those equations provides the approximate behavior of the time.

FATIGUE MECHANISMS:

The basic feature that underlies all the specific fatigue failure mechanisms is the existence of repeated or cyclic stresses at some point of the component. This could be considered the basic definition of fatigue. The cyclic stress sensor strains give origin to damage accumulation until it develops into a crack that finally leads to failure of the component. Keeping in mind the basic assumption for a fatigue failure, different definitions will be provided for the specific fatigue failure mechanisms. The different fatigue failure mechanisms are essentially related to the way those cyclic stresses arise in a specific point of the component, or to the cause of the stresses. Sometimes they are also related to the existence of other concurrent or synergistic damaging mechanisms such as wear or corrosion.

III. EXPERIMENTAL RESULTS

From the below figures shows different types of materials and by applying different loads, at each load, find out deformation, strain, stress and life cycle of the wheel rim.

The analysis of the wheel rim by the ANSYS software, to find out which materials will be giving to less deformation, stress ,strain and also observing of less weight of materials and high strength.

Figures shows analysis of automotive wheel rim, **Fig -1:** Mesh figure in Ansys, **Fig -2:** Deformation of aluminum at 1500N of Load, **Fig -3:** Stress of aluminum at 1500N of Load, **Fig -4:** Factor of Safety of aluminum at 1500N of Load, **Fig -5:** Deformation of Kevlar at 1500N of Load, **Fig -6:** Stress of Kevlar at 1500N of Load, **Fig -7:** Safety Factor of Kevlar at 1500N of Load, **Fig -8** Deformation of carbon fiber at 1500N of Load, **Fig -9:** Stress of carbon fiber at 1500N of Load, **Fig -10:** Safety Factor of carbon fiber at 1500N of Load

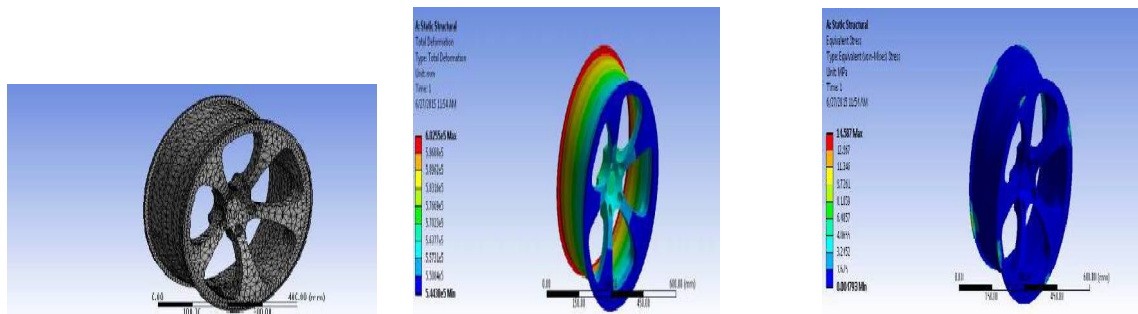

Fig -1: Mesh figure in Ansys

Fig -2: Deformation of aluminum at 1500N of Load

Fig-3: stress of aluminium at 1500 load

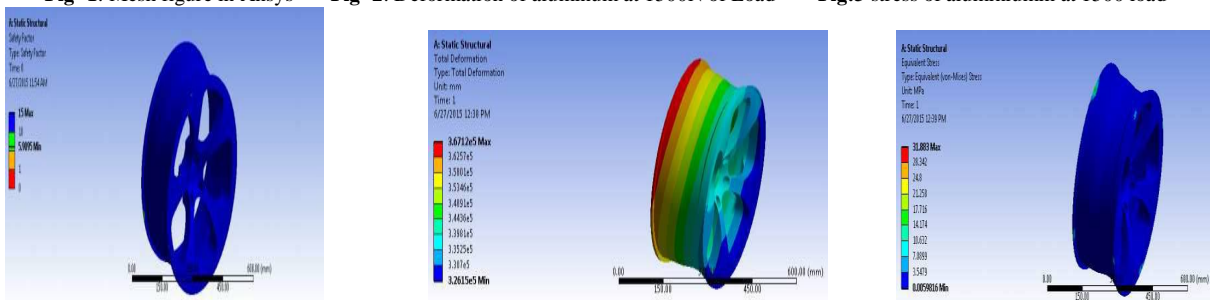

Fig -4: factor of safety of aluminum at 1500N of Load **Fig -5:** Deformation of Kevlar at 1500N of Load **Fig -6:** Stress of Kevlar at 1500N of Load,

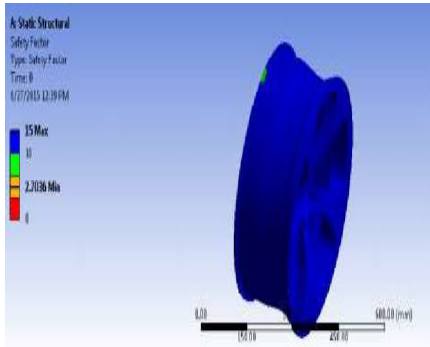

Fig -7: Safety Factor of Kevlar at 1500N of Load

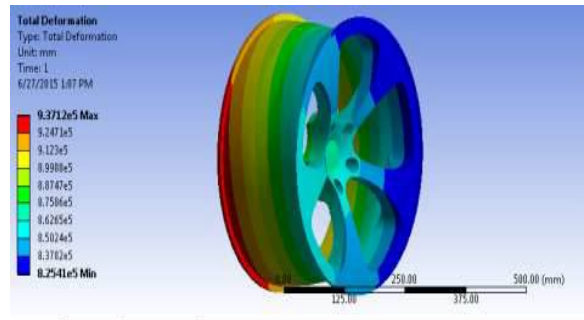

Fig -8 Deformation of carbon fiber at 1500N of Load

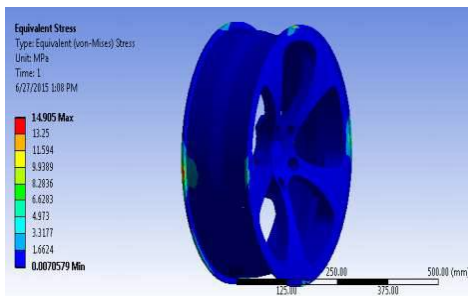

Fig -9: Stress of carbon fiber at 1500N of Load

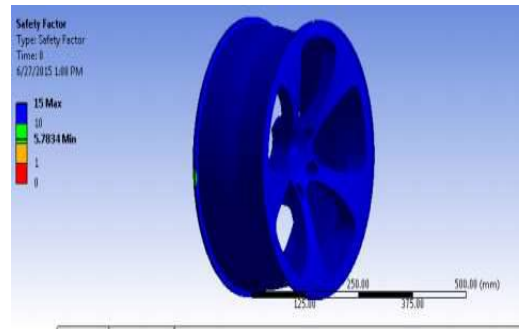
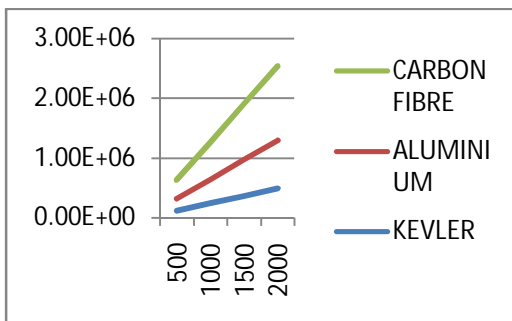

Fig -10: Safety Factor of carbon fiber at 1500N of Load

IV RESULTS

DEFORMATION:



LOAD	KEVLAR	ALUMINIUM	CARBON FIBRE
500	1.22E+05	2.01E+05	3.12E+05
1000	2.45E+05	4.02E+05	6.25E+05
1500	3.67E+05	6.03E+05	9.37E+05
2000	4.89E+05	8.03E+05	1.25E+06

Graph and table 1 representing the deformation values

By observing the above table above we can say that Kevlar is having less deformation when compared to other material as we had chosen load along x-axis and deformation along y axis carbon fiber has got the deformation of 1.25e+06 whereas aluminum got 8.03e+05 and Kevlar as 4.89e+05 by these values it can be said that Kevlar will be having less deformation.

International Journal of Innovative Research in Science, Engineering and Technology

(An ISO 3297: 2007 Certified Organization)

Vol. 5, Issue 4, April 2016

STRESS:

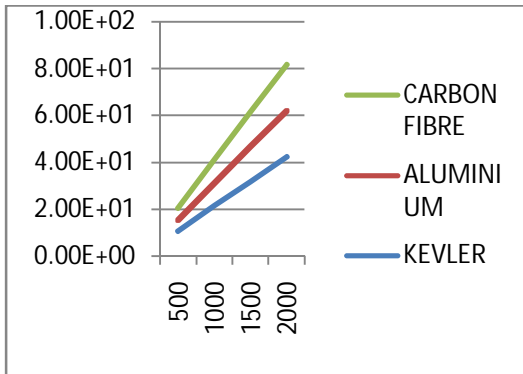

LOAD	KEVLAR	ALUMINIUM	CARBON FIBRE
500	1.06E+01	4.86E+00	4.97E+00
1000	2.16E+01	9.72E+00	9.94E+00
1500	3.19E+01	1.49E+01	1.49E+01
2000	4.25E+01	1.94E+01	1.99E+01

Graph and table 2 showing the values of stress

By observing stress factors in the table Kevlar having capability of withstanding the stresses at different loading condition. Carbon fiber has the value of 1.99e+01 and whereas the other materials aluminum has the value of 1.94e+01 and carbon fiber has 1.99e+01. We had considered stress in MPa and Load in N.

WEIGHT COMPARISON OF MATERIALS:

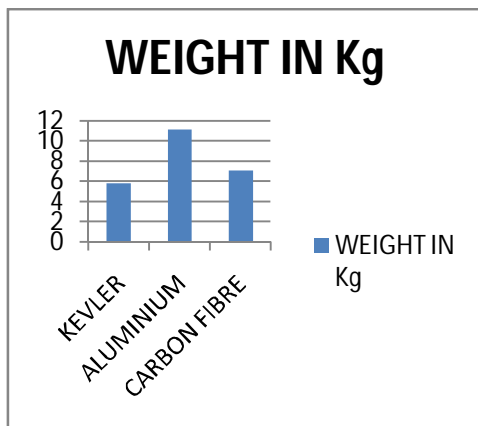

WEIGHT	WEIGHT IN Kg
KEVLAR	5.82
ALUMINIUM	11.13
CARBON FIBRE	7.07

Graph and table 3 showing weight comparison

By considering material weight we can say that Kevlar has less weight of 5.8185 when compared with other two materials.

International Journal of Innovative Research in Science, Engineering and Technology

(An ISO 3297: 2007 Certified Organization)

Vol. 5, Issue 4, April 2016

Safety factors:

ALUMINIUM:

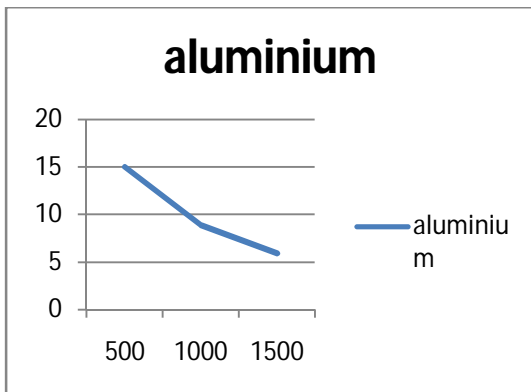

load	aluminium
500	15
1000	8.8642
1500	5.9095

Graph and table 4 showing the safety factor of aluminum

By observing the above graph we can say that aluminum has an factor of safety of 15 when when we had considered and here we had appalled a load of 500, 1000, 1500, 2000 in x-axis and the safety factor was considered in y-axis as the load increasing the factor of safety decreasing.

KEVLAR:

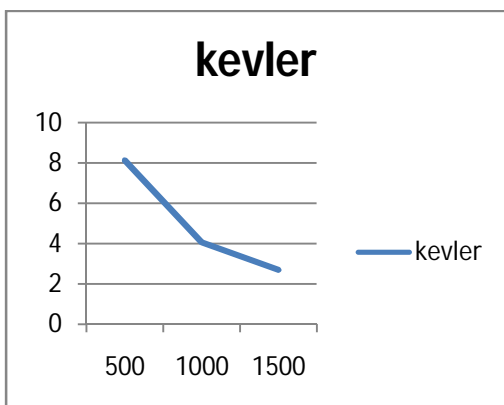

load	kevlar
500	8.1108
1000	4.0554
1500	2.7036

Graph and table 5 showing the safety factor of Kevlar

By observing the above graph we can say that kevlar has an factor of safety of 15 when when we had considered and here we had appalled a load of 500, 1000, 1500, 2000 in x-axis and the safety factor was considered in y-axis as the load increasing the factor of safety decreasing.

International Journal of Innovative Research in Science, Engineering and Technology

(An ISO 3297: 2007 Certified Organization)

Vol. 5, Issue 4, April 2016

CARBON FIBRE:

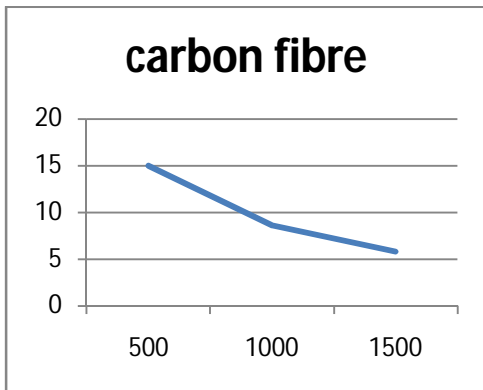

load	carbon fibre
500	15
1000	8.625
1500	5.7834

Graph and table 6 showing the safety factor of carbon

By observing the above graph we can say that carbon fiber has an factor of safety of 15 when when we had considered and here we had appalled a load of 500, 1000, 1500, 2000 in x-axis and the safety factor was considered in y-axis as the load increasing the factor of safety decreasing.

V.CONCLUSION & FUTURE WORK

- 1) To optimization of material thickness to scale back the material consumption.
- 2) Improve lifetime of part by victimization advanced fatigue stress life approach for wheel rims.
- 3) Kevlar has a vary of benefits, not only its relative low weight and high strength carbon is incredibly stable at high temperatures and its impact and scratch resistant.
- 4) Kevlar is usually combined with alternative materials, to produce textiles with increased properties, like fire resistant clothing for the fireplace Services.
- 5) Kevlar is employed in some quality walking boots as a result of its waterproof (when combined with alternative materials as a composite) however but breathable, ensuring comfort.
- 6) When Kevlar is employed as a composite with rubber, it retains its flexibility. This stuff is employed within the manufacture of Formula One racing car gasoline tanks. The tank holds the gasoline safely, even within the event of an accident so as an extnt we can suggest Kevlar for rims.
- 7) In this paper we had done stress, deformation, safety factor for wheel rims with different materials at different conditions and the results were obtained by observing deformations Kevlar has less deformation and weight.
- 8) By comparison of weight reduction of rim we can suggest Kevlar material for rims and by verifying deformation Kevlar has less deformation by this also we can say Kevlar can be suggested based on the parameters we considered.

REFERENCES

- [1] K. Mahadevan and Balaveera Reddy, "Design Data Hand Book".
- [2] "Finite Element Analysis", Chandra Pautla.
- [3] "Strength Of Materials", Ramambrutham.
- [4] "Ansys User Manual",
- [5] "Metal Fatigue" , Ralfh Stefunson, Ali Fatemi & A.O.Cuph.
- [6]"MSC Fatigue User Manual",
- [7]Metal fatigue in engineering by Stefan.
- [8]Fatigue Life Analysis of Aluminum Wheels by Simulation of Rotary Fatigue Test Liangmo Wang* - Yufa Chen - Chenzhi Wang - Qingzheng Wang School of Mechanical Engineering, Nanjing University of Science & Technology, China
- [9]Fatigue properties of a cast aluminum alloy for rims of car wheels. C.Bosi,G.L.Garagnani .