

# **Separating Fetal ECG Signal from Maternal ECG Using ANFIS with Gamma Filter in VLSI**

Dr. S. Hemajothi<sup>1</sup>, Dr. V. Thulasi Bai<sup>2</sup>, R. Ranjeetha<sup>3</sup>

Professor, Department of Electronics and Communication Engineering, Prathyusha Engineering College, Thiruvallur,  
Tamil Nadu, India<sup>1</sup>

Professor, Department of Electronics and Communication Engineering, Prathyusha Engineering College, Thiruvallur,  
Tamil Nadu, India<sup>2</sup>

P.G. Student, Department of Applied Electronics, Prathyusha Engineering College, Thiruvallur, Tamil Nadu, India<sup>3</sup>

**ABSTRACT:** The cardiovascular states of any individual will distinguish working of the human respiratory framework and it is dictated by electrical movement of heart known as Electro Cardio Gram (ECG). This appropriate working of heart will lead the human life more advantageous. Then again, the Fetal ECG (FECG) used to analyze the baby heart condition in the fetal stage. Hence this fetal ECG signal which is consolidated with maternal heart of the pregnant lady should be removed. This separated fetal ECG will identify the sound state of the youngster. The proposed framework isolates the FECG from MECG utilizing ANFIS with Gamma filter procedure. This strategy actualized in VLSI with the favorable circumstances like increment in velocity, least mean square mistake, along these lines we can maintain a strategic distance from youngster with Congenital Heart Disease (CHD) and neo natal demise.

**KEYWORDS:** CHD, ANFIS, MECG, FECG, Neonatal Death.

## **I. INTRODUCTION**

Electrocardiogram gives the electrical movement of the heart of the person, in this manner the best possible ECG waveform gives the correct working of the heart. The hatchling ECG in the pregnant lady incorporates clamors like MECG, electrical cable impedence, movement curio, among these MECG is most transcendent consequently it must be uprooted. The concealed states will be straight and non-direct element model introduced in [1] utilize the extra highlighted form of kalman channel to discrete the required signal.

The five conspicuous purposes of the ECG sign of the person gives the cardiovascular conditions introduced in [2] that suppresses MECG to get FECG.

The thoracic area with the maternal ECG and the mother ECG together with fetal ECG present in the stomach part of the pregnant lady. The fuzzy derivation framework alongside the neural system shapes an Adaptive Neuro Fuzzy Inference System (ANFIS) procedure, that used to isolated fetal ECG from the maternal Electrocardiogram. The signal is isolated by the recognizable proof of the pieces of information that is prepared to the neural system which is displayed in [3].

The three stage strategy is considered where the primary stage used to evacuate the most prevalent focuses in the waveform of ECG. The QRS focuses among the conspicuous focuses must be evacuated in the stage one. The following stage utilizes two methodologies which incorporate Heuristic Algorithm and Histogram procedure that used to evacuate the R-crest. This R-crest cover with the maternal QRS complex. Thus it is uprooted and it is introduced in [4].

Similarly, the other paper incorporates 3 stage approach, where by considering the R-crest the QRS complex of the mother's ECG sign is evacuated and with the stomach ECG recording of the pregnant lady, the fiducial purposes of the maternal ECG sign are uprooted in the principal stage. The QRS complex of the fetal ECG sign are improved and done in second stage. At that point in third stage the sign of the embryo is recuperated is displayed in [5].

# International Journal of Innovative Research in Science, Engineering and Technology

(An ISO 3297: 2007 Certified Organization)

Vol. 5, Issue 4, April 2016

The neural system that prepares the systems from the fundamental facts that used to distinguish it them legitimately, the fuzzy rationale strategy consolidated with the neural system framework, in this way the Adaptive Neuro Fuzzy Inference [ANFIS] introduced in [6].

The Independent Component Analysis [ICA] dissect numerous parts in different dimensional which it implies that it takes different perception about the ECG sign of the pregnant lady, consequently the Multidimensional Independent Component Analysis (MICA) is exhibited in paper [7] that used to discrete the ECG sign of the hatchling from the maternal heart beat sign.

The neural framework with the fuzzy rationale (ANFIS) and the Undecimated Wavelet Transform (UWT) exhibited in [8] portrays about the method without the reduction in the testing rate, instead of by the preparation of the neural system the framework can distinguish the fetal flag and can be separated from the maternal ECG with denoising methodology and great sign quality in that capacity.

The Singular Value Decomposition (SVD) and the Cyclostationary – based Blind Source Separation (C-BSS) are the two methodologies introduced in [9]. These two hypotheses with the wavelet change used to partitioned the fetal heart beat from the maternal heart beat of the signal. The Blind Source Separation in which there is no predefined data or any knowing any information about the coveted sign need. In this way by the investigation of the sign is finished with the higher request cyclic recurrence the coveted sign is gotten.

This paper [10] portrays about the customary strategy for the Blind Source Separation. The conventional technique incorporates Independent Component Analysis (ICA). The trademark division of the heart beat sign is given by the wavelet change with variety in determination and the programming of the neural system to set the legitimate information set.

The accompanying segment gives the brief depiction about the proposed framework system. The ecofriendly Verilog coding is utilized for the proposed framework as a part of which the ANFIS with Gamma Filter system is executed.

## II. METHODOLOGY

ANFIS with Gamma Filter is executed in the Very Large Scale Industry (VLSI) utilizing the Verilog coding. Utilizing this Gamma Filter system as a part of VLSI the rate can be expanded the sign quality gets expanded by minimizing the mean square blunder. The hypothetical astute depiction of the proposed framework is appeared underneath :

### 2.1 ANFIS WITH GAMMA FILTER :

Versatile Neuro Fuzzy Inference System is the blend of both the fuzzy rationale and the neural systems. This is combined with the Gamma filter which it the combination of both the features of the IIR and FIR filters.

Fuzzy rationale and neural system are the two advancements in which they are complimentary to each other."if-then" principles is utilized as a part of fluffy standard based framework. Neural system and fluffy rationale can ready to consolidate to shape new innovation Adaptive Neuro Fuzzy Inference System (ANFIS).

The Adaptive systems are practically proportional to the fuzzy rationale induction framework. Here the ANFIS engineering speak to the Sugeno and Tsukamoto fuzzy models.

The accompanying demonstrates the main request Sugeno fuzzy model with two after principles.

Let X and Y be the two inputs

$$f_1 = p_1X + q_1Y + r_1 \quad \text{-----(1)}$$

$$f_2 = p_2X + q_2Y + r_2 \quad \text{-----(2)}$$

$$f = (\sim W_1 f_1 + \sim W_2 f_2) / (W_1 + W_2) \\ = \sim W_1 f_1 + \sim W_2 f_2 \quad \text{-----(3)}$$

# International Journal of Innovative Research in Science, Engineering and Technology

(An ISO 3297: 2007 Certified Organization)

Vol. 5, Issue 4, April 2016

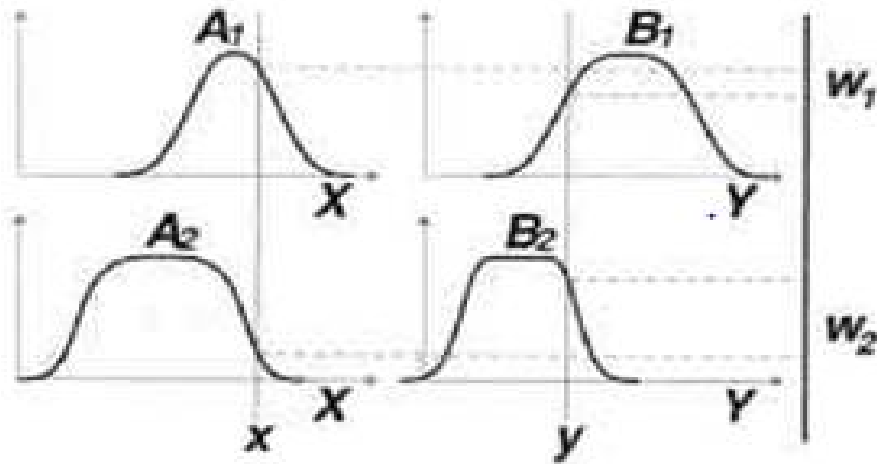

Fig. 1 Sugeno Fuzzy Model

**“if-then” Rules :**

**Rule 1:** If X is  $A_1$  and Y is  $B_1$   
Then  $f_1 = p_1X + q_1Y + r_1$

**Rule 2:** If X is  $A_2$  and Y is  $B_2$   
Then  $f_2 = p_2X + q_2Y + r_2$

**Equivalent Architecture of ANFIS**

The following diagram shows the ANFIS architecture with 5 different layers. Each layer performs different operation on each stage.

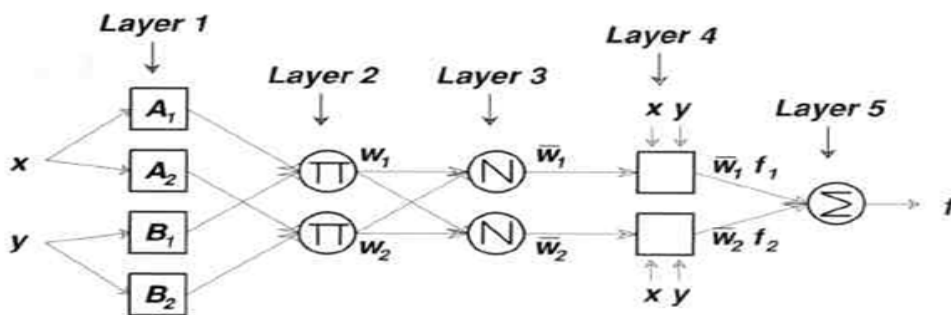

Fig. 2 ANFIS architecture

Gamma anfis model combines with neural network adaptive capabilities and the fuzzy logic qualitative approach to remove noise present in FECG. Gamma filter is more efficient than Adaline Filter. It has desirable feature of both the filters which have Trival Stability, Easy adaptation and yet uncoupling.

# International Journal of Innovative Research in Science, Engineering and Technology

(An ISO 3297: 2007 Certified Organization)

Vol. 5, Issue 4, April 2016

## III. PROPOSED METHOD

In the proposed framework, the ANFIS with Gamma channel procedure is executed in VLSI which has the accompanying focal points like increment in velocity, high flag quality, with less number of mistake, less power utilization. The Hardware Description Language (HDL) code is utilized as programming dialect as a part of VLSI. Verilog coding and VHDL coding goes under HDL programming. Basic model, Behavioral model, Data stream model are the three models used to compose Verilog code. Among these models basic model is utilized to actualize ANFIS with Gamma channel in Verilog coding.

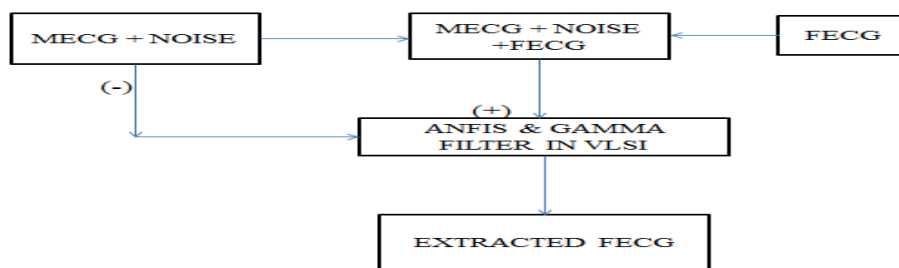

Fig. 3 Block Diagram

## IV. EXPERIMENTAL RESULTS

The accompanying demonstrates the exploratory consequence of the proposed framework, with the maternal ECG along noise, fetal ECG, and the extracted yield.

### 4.1 THORACIC SIGNAL:

The thoracic sign is totally the mother's ECG signal which is taken from the thoracic district (mid-section bit of the mother) is appeared in figure 4.

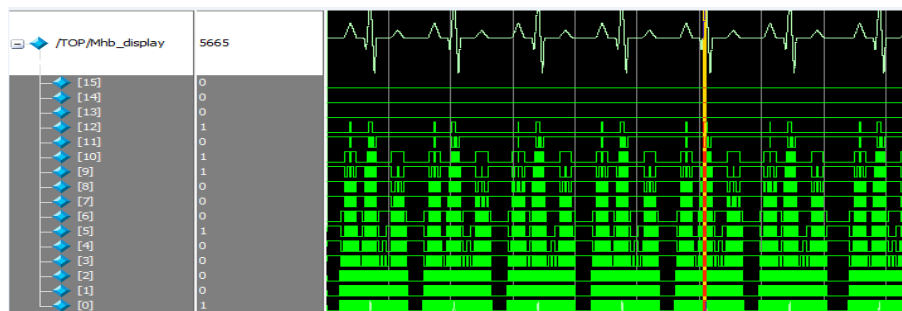

Fig. 4. Thoracic Signal

### 4.2. ABDOMINAL SIGNAL:

Stomach signal comprises of both Mother's ECG and Fetus ECG alongside the commotions like movement relic, power line obstructions, and so on. This is shown in figure 5.

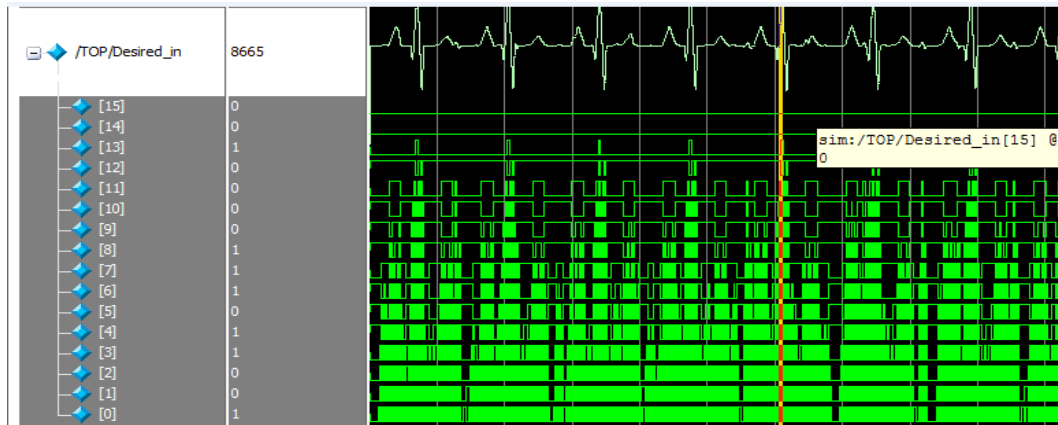

Fig. 5. Abdominal Signal

**4.3. FETAL ECG :**

The Fetal ECG signal which is to be extracted, that has less abundance than maternal ECG signal and higher recurrence than mother's ECG. This is taken as reference signal shown in figure 6.

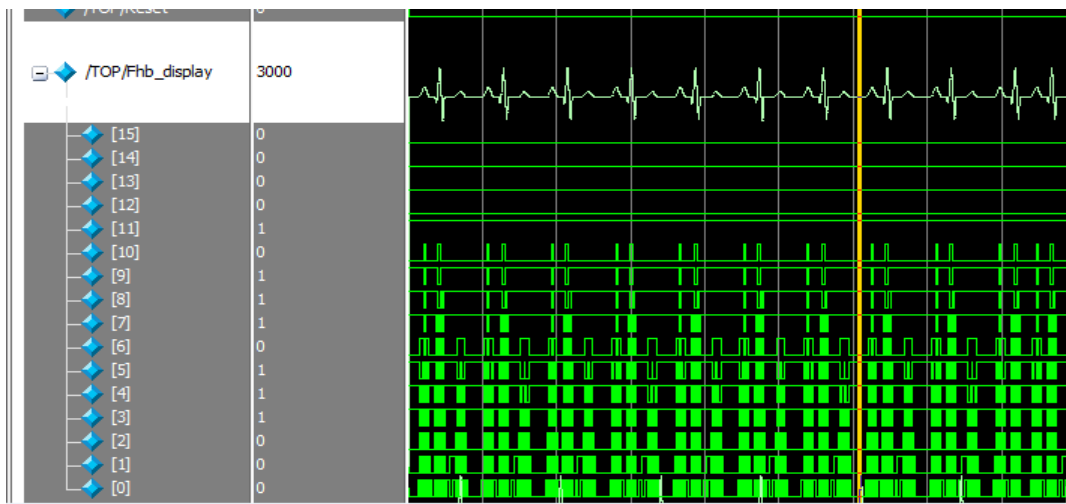

Fig. 6. Fetal ECG

**4.4 EXTRACTED OUTPUT :**

The desired FECG is extracted from the MECG and noises using the ANFIS technique. It is checked with the reference signal for any error and signal quality. Figure 7 shows the extracted output.

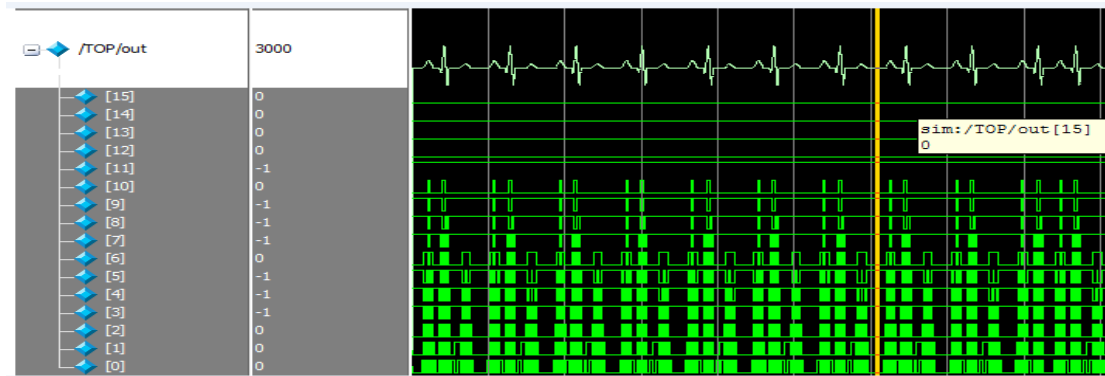

Fig.

**7. Extracted output**

**4.5. TABULATION :**

The following Table.1 shows the experimental results of the signal extraction in FPGA. Among these Virtex 4 have less delay which is denoted in speed grade and have less memory which is easy to implement.

S. NO.	FAMILY NAME	PACKAGE	DEVICE	SPEED GRADE	MEMORY
1	Spartan	PQ208	XC3S50	-5	282868KB
2	Virtex 4	SF363	XC4VFX12	-12	272332KB
3	Virtex 5	FF323	XC5VLX207	-2	282502KB
4	Virtex 7	FFG1157	XC7VX3307	-3	443492KB

Table. 1

**V. CONCLUSION**

In this venture ANFIS with Gamma channel procedure which is joined capacity of Neural system and Fuzzy rationale is actualized in VLSI utilizing Verilog coding and the fetal ECG is separated. The outcome demonstrates that the extricated fetal ECG is of least mean square and with high flag quality. And also Virtex 4 provides the less delay and hence it can be used for the implementation.

**REFERENCES**

- R. Sameni , M.B Shamsollahi, C. Jutten, "Filtering Electrocardiogram Signals Using the Extended Kalman Filter", IEEE Engineering in medicine and Biology, 27<sup>th</sup> National Conference, 0-7803-8740-6, 2005.
- Evaggelos C. Karvounis, Markos G. Tsipouras, Dimitrios I. Fotiadis, "The Maternal ECG Suppression Algorithm for Efficient Extraction of the Fetal ECG from Abdominal Signal ", IEEE transactions 28<sup>th</sup> Annual International Conference, 1-4244-0033-3, 2006.
- Khaled Assaleh, "Extraction of Fetal Electrocardiogram Using Adaptive Neuro-Fuzzy Inference Systems", IEEE transactions on Biomedical Engineering, vol.54, no.1, pp. 0018-9294, 2007.
- A. Matonia, J. Jezewski, K. Horoba, A. Gacek, "An Automated Methodology for Fetal Heart Rate Extraction From the Abdominal Electrocardiogram", IEEE transactions on Information Technology in Biomedicine, vol.11, no.6, pp. 1089-7771, 2007.
- E.C. Karvounis, M.G. Tsipouras, D.I. Fotiadis, "Fetal heart rate detection in multivariate abdominal ECG recordings using non-linear analysis ", 30<sup>th</sup> Annual International Conference, 978-1-4244-1815-2, 2008.
- Wenjuan JIA, Chunlan YANG, Guocheng ZHONG, Mengying ZHOU, Shuicai WU, " Fetal ECG Extraction Based on Adaptive Linear Neural Network", 3<sup>rd</sup> International Conference on Biomedical Engineering and Informatics, 978-1-4244-6498-2, 2010.
- J. L. Camargo-Olivares, R. Martín-Clemente, S. Hornillo-Mellado, M. M. Elena, and I. Roman, "The Maternal Abdominal ECG as Input to MICA in the Fetal ECG Extraction Problem", IEEE transactions on Signal Processing Letters, vol. 18, no.3, pp. 1070-9908, 2011.
- S.Hemajothi ,K.Helan prabha, "FECG extraction using Adaptive Neuro-Fuzzy inference System and Undecimated Wavelet Transform", IETE Journal of Research, vol.58, issue 6, 2012.
- Xiao Ping Zeng, ShaoHua Li, GuoJun Li, Yu Zhou, and DaiHui Mo, "FetalECG Extraction by combining single-channel SVD and Cyclostationarity Base Blind Source Separation", International Journal of signal Processing, Image Processing and Pattern Recognition, vol. 6, No. 4, 2013.
- Ankit Sanghvi, Sachin M. Bojewar, "ECG Signal Classification Using Hidden Markov Model and Artificial Neural Network", International Journal of Engineering Research & Technology, vol. 3, issue 2, 2014.