

# Fuzzy Logic Techniques and Wavelet Transform Based Differential Protection for Power Transformer

Suribabu Miriyala<sup>1</sup>, Dr.Sanker Ram<sup>2</sup>Research Scholar, Department of Electrical Engineering, JNTUA, Anantapur, A.P, India<sup>1</sup>Professor, Department of Electrical Engineering, JNTUCEH, Telangana, Hyderabad, India<sup>2</sup>

**ABSTRACT:** Power transformers are important devices in the power system. Reliability and stability of the whole power system are the primary issues concerning transformers. Transformer relaying protection of automation system is critical for the safe operation of transformers. This paper presents the development of a wavelet based algorithm, for distinguishing between magnetizing inrush currents and power system fault currents, which is quite adequate, reliable, fast and computationally efficient tool. The proposed technique consists of a pre- processing unit based on wavelet transform (WT) in combination with a Fuzzy Logic (FL) for detecting fault currents. The WT acts as an extractor of distinctive features in the input signals at the relay location. This information is then fed into a Fuzzy Logic (FL) for Detect fault and magnetizing inrush conditions. The WT was implemented by using Matlab and Coiflet mother wavelet was used to analyze primary currents and generate tuning data. The simulated results presented clearly show that the proposed technique can accurately discriminate between magnetizing inrush and fault currents in transformer protection.

**KEYWORDS:** Differential Protection, Power transformer, Wavelet Transforms, Fuzzy Logic (FL), Inrush Current, Internal Fault.

## I. INTRODUCTION

POWER transformers are subject to different types of transient disturbances, including magnetizing inrush, internal fault, external fault, and through-fault currents [1]–[5]. Furthermore, the nature of power system elements aids such disturbances to gain certain complex characteristics. Such characteristics may include no periodic, no stationary, short duration, fast decaying, and impulse superimposed components [4]–[8]. The power transformer is subjected to various types of transients and hence accurate discrimination between a fault and normal operating condition is essential to carry out the protective action carried out [3]. There have been many earlier approaches to realize the current distinguishing task for power transformer protection. However, these approaches had predefined conditions and assumptions to validate their applications. Some of these predefined conditions do not match with natures of the considered disturbances [4], [5], [7], [8].

Earlier analysis of some investigated disturbances showed that harmonic contents of power transformer differential currents contain significant information about these disturbances. Such information includes frequency contents of the differential current under different disturbances. Differential protection is the main protection scheme applied in power transformers, presenting reliable discrimination between internal faults and external faults or conditions of normal loading system. However, the differential protection presents significant sensitivity under certain conditions such as magnetizing inrush current, and transformer over excitation. To overcome the limitations of the conventional differential protection, the element with harmonic restraint was introduced in the differential relays. In [9] was proposed a relay based on the principle of harmonic restraint, being able to distinguish between the differential currents due to an internal fault and due to inrush currents, and operating at high speed on the fault current and restricting the operation in the presence of magnetization current. For a certain excess in percentage of the second harmonic, the relay is restrained, in this method. [10] even though this method provided security against inrush and over excitation, it performed below expectation, for low harmonic content of operating current. [11].

# International Journal of Innovative Research in Science, Engineering and Technology

(An ISO 3297: 2007 Certified Organization)

Vol. 5, Issue 12, December 2016

In order to improve power transformer protection, new techniques and methodologies based on intelligent tools have been developed to discriminate efficiently the internal faults from other disturbances or switching operations. A new approach to differential protection in power transformer using FL technology enhances on tuning capability. Simulation of the power transformer under varying conditions was done and the results compared with the test data for the proposed relay scheme. The proposed algorithm, proved to be better in recognizing various faults on the transformer. This gave the necessary confidence to achieve fast, accurate, fail safe method for interpretation of fault Vs magnetizing inrush current [2]–[11]. The basic structure of a differential relay for transformer protection scheme Figure1

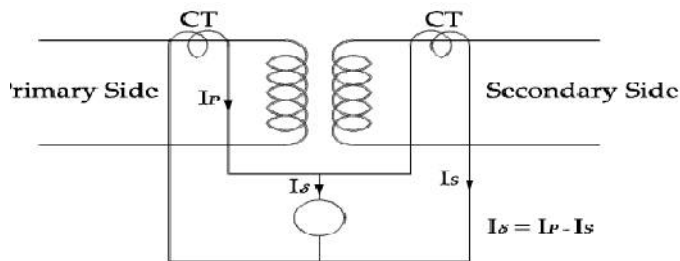

Fig. 1 Basic structure of a differential relay - transformer protection scheme

The proposed technique has achieved with Minimum Features, the maximum possible classification rate for the monitoring of the transformer faults for inrush and internal faults.

## II. WAVELET TRANSFORM

Transients in a Power system are initiated every time whenever there is a change of system operational conditions these can be analyzed using Wavelet transform. Analysis of data for a fault, in various research publications, revealed that the data is very rich in providing information about the operational details of the power system so, wavelet analysis is suitable for transient signal analysis as measured by protective relays. [12].

The WT is an efficient signal processing tool used in power system analysis [13]–[15]. The WT and STFT allow different frequency components to be time localized, with fixed window width function as in STFT. This gives the predetermined time and frequency resolution. However the WT using wavelets as the analyzing function have a self-adjusting capability to the time widths in relation to frequency thereby creating a Inversely related frequency / width wavelet, i.e greater frequency - narrow width and vice versa.

Transients create higher frequency components and have shorter time intervals, in contrast to lower frequency components and higher time intervals. WT has the inherent advantage of focusing on shorter time intervals, thereby picking transients for analysis. For this reason, to study transient signals, for achieving reliable discrimination based on current characteristics, Wavelet decomposition is ideal. [15].

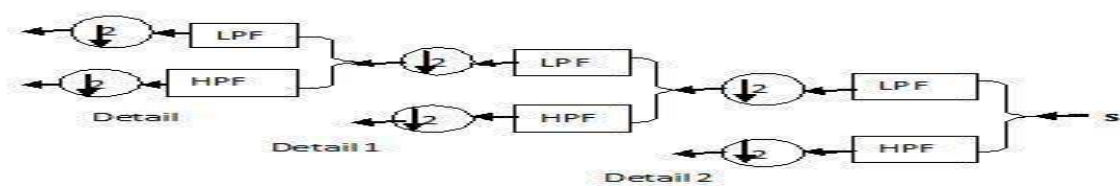

Fig. 2 Implementation of WT

Fig. 2 illustrates the implementation Discrete WT (DWT), S - original signal, LPF and HPF: low-pass and high-pass filters respectively. The analysis is done by successive decomposition of the signal i.e. the signal is bifurcated and the two components passed through HPF and LPF. The output of the LPF is again bifurcated and sent through HPF and

# International Journal of Innovative Research in Science, Engineering and Technology

(An ISO 3297: 2007 Certified Organization)

Vol. 5, Issue 12, December 2016

LPF and this process is repeated up to a predetermined level of decomposition. According to Nyquist's theorem, a signal of frequency  $F_s$  should be sampled  $2F_s$  times to get the complete characteristics while reconstruction, and as a corollary sampling  $F_s$  times would give a maximum frequency  $F_s/2$ . Thus  $F_s/2, F_s/4; F_s/4, F_s/8$  and so on are the frequencies in the first, second details and so on. This paper has considered a sampling frequency of 10 kHz.

### III. FUZZY LOGIC SYSTEM (FL)

Fuzzy inferencing method is basically an inferencing process for a given input so as to provide an output using knowledge base / rule base which consist of number of rules. This system helps the fuzzy controller to understand different parameters and to make the rules in accordance to it. The fuzzy system is used to deal with the input imprecisions without data loss during processing and to determine the fault condition more accurately than conventional differential protection methods. Some of the steps of the fuzzy logic are:

**1. Fuzzification:** It is a process of transforming a classical set into fuzzy set or it is a process of translating an uncertain event into fuzzy set by assigning a proper membership function or it is a process of transforming a scalar value into a fuzzy value. This is achieved with different types of fuzzifiers. There are generally three types of fuzzifiers, which are used for fuzzification process; they are Singleton fuzzifier, Gaussian fuzzifier and Trapezoidal or Triangular fuzzifier.

**2. Knowledge and Rule Base:** In this stage a knowledge data base is built which forms the rules for the control operations. These are in the form of IF-THEN-ELSE format. For example

**3. Inference Engine:** These are the types of the method with the rule base so as to obtain the fuzzy values. There are basically two types of methods which we are using in this:

i. Mamdani methodii. Sugeno method

**Mamdani Method:** It is a graphical technique of inference. It is a simple rule system which comprises of two hypotheses and one conclusion. This method is the most common, easy to understand and hence in use in most of the cases. Mamdani's logic gets its basics from the Lofti's Zadeh's 1973 paper. In this paper Lofti suggested fuzzy method or algorithm for decision making of complex systems. Mamdani using the method suggested by Lofti and using the linguistic control rules given by plant operators tried to control a steam engine and thus framed a rule base, now known as Mamdani's rule base. Advantages of Mamdani Method:

- It is intuitive.
  - It can be implemented in most of the problems.
  - It can easily be understood by humans as it contains language rules.
- Sugeno Method:** A type of fuzzy inference in which the consequent of each rule is a linear combination of the inputs. The output is a weighted linear combination of the consequents. It is suited to mathematical analysis.

**4. Defuzzification:** It is the reverse process of fuzzification. In defuzzification we convert the fuzzy set or fuzzy value into real set or real scalar. There are five methods for defuzzification:

- Centroid methodii. Bisector methodiii. Middle of Maximumiv. Smallest of Maximum
- Largest of Maximum
- The most commonly used method among all is the centroid method
- In this stage the fuzzy output variables is converted to a crisp value based on a Defuzzification rule. In fuzzy logic, these parameters are found in the fuzzification and defuzzification routines and it can be trained. Membership and their associated degrees are based on IF-THEN rules [18].
- Fig. 2 represents the Implementation of WT, as a block diagram. The inputs are obtained by pre-processing primary and secondary current signals [19].

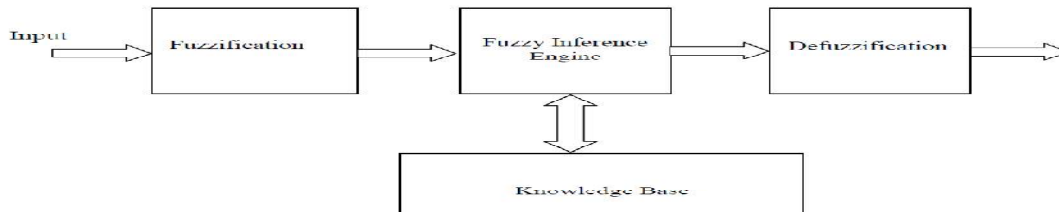

Fig 3 Shows the Fuzzy Inference System

- j) The inputs at the input layer and the outputs at the output layer have single neurons representing a value either a 0 or a 1 which indicates no tripping or a tripping respectively. The sampling is done for three phase signals of both primary and secondary of the transformer where in the magnitudes of the samples are obtained. The inputs of these units are 1st harmonic primary current and secondary current, 2nd harmonics of primary and secondary current, ratio of 1st harmonic component of the differential current to primary current and ratio of 2nd harmonic component of the differential current to primary current [20]
- k) The salient feature of the new method is elimination of load tap changer error of the three phase transformer and thereby sensitivity of the relay is improved over the conventional algorithm and time taken for training and testing is greatly reduced. Fig. 2 represents the Fuzzy Inference System. The designed Fuzzy Logic (FL) network in MATLAB/ SIMULINK is shown in Fig. 4 and Architecture of Fuzzy Logic (FL) model is designed as in Fig. 5.

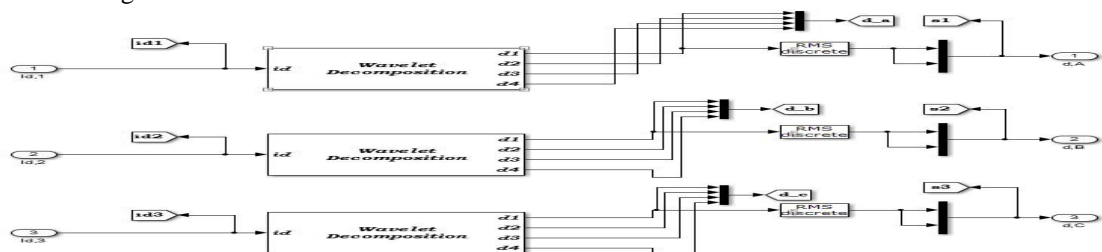

Fig.4 Simulation diagram of Wavelet with Fuzzy Logic (FL)

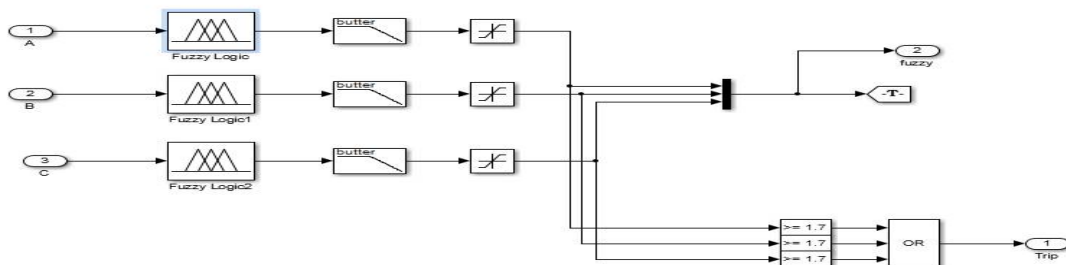

Fig.5 Simulation model of Fuzzy Logic (FL)

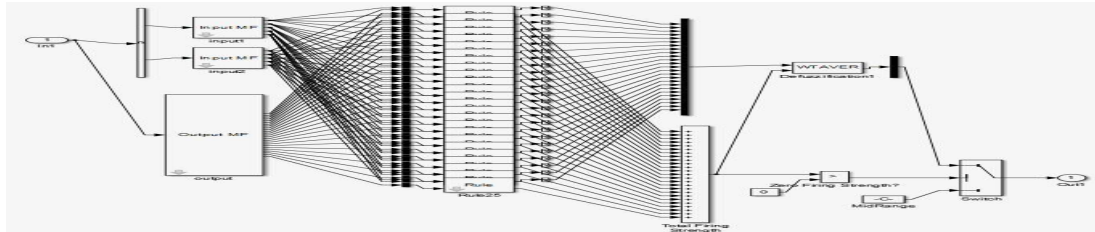

Fig.6 Architecture of ANFIS

**III (a) Algorithm for ANN**

- l) The flowchart of the algorithm for ANN based relaying is shown in Figure 7 and is explained in steps.
- m) **Step 1:** The current and voltage signals are obtained from the three phase transformer using MATLAB /SIMULINK software for different types of fault and no fault conditions.
- n) **Step 2:** The differential current for the various cases are calculated.
- o) **Step 3:** The first 600 samples i.e., samples in one cycle, of the differential current after the occurrence of the fault or no fault condition are fed to ANFIS and trained. The output of the fault samples are assigned '1' and the output of the no fault samples are assigned '0'.
- p) **Step 4:** Next, the trained relay is tested with the cases which are not used for training.

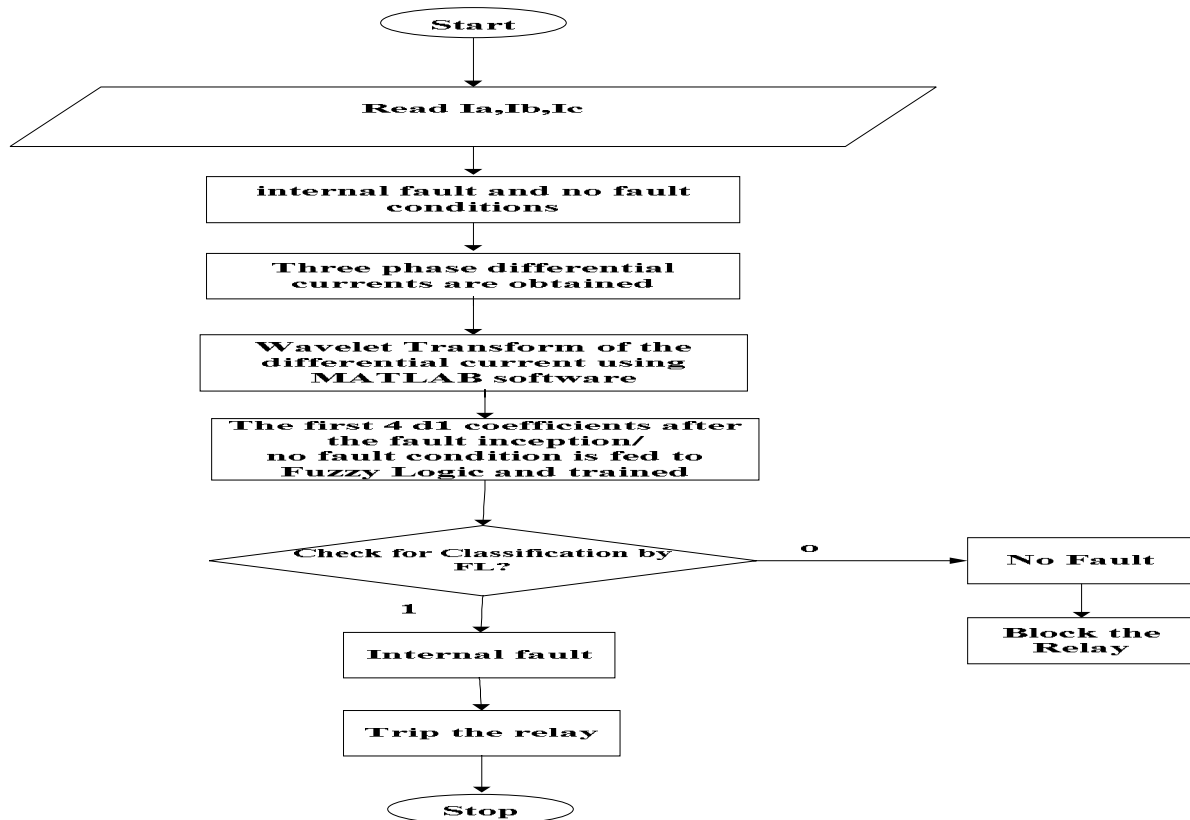

Fig.7 Flowchart of the algorithm for Fuzzy Logic (FL)

## IV. SIMULATION RESULTS

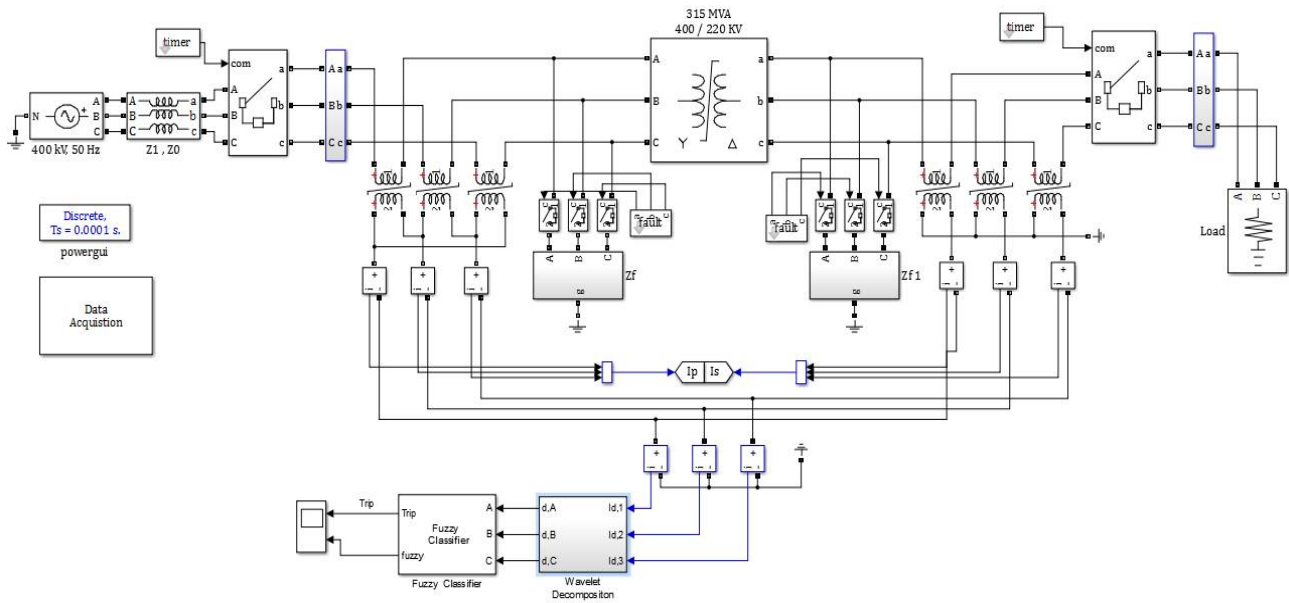

Fig. 8 Configuration of Power Transformer

The proposed technique is tested on the model of a 3- $\Phi$ , 315-MVA, 400/220-kV, 50-Hz core-type Y- $\Delta$  power transformer [20]. The 400kVA power transformer is configured as a step-down transformer; its configuration is shown in Fig. 1. In this work, the grounding is Implemented using a resistance  $R_G = 0.5\Omega$  and leakage inductance 0.8mH. The ground resistance  $R_G$  connects the neutral point of the Secondary windings with the ground. The experimental setup used for online tests of both power transformers is shown in Fig.7. Two sets of 3 identical CTs, one each on primary and secondary are employed and the methods used to simulate the various faults, was explained earlier.

### Case 1: Magnetizing Inrush Current:

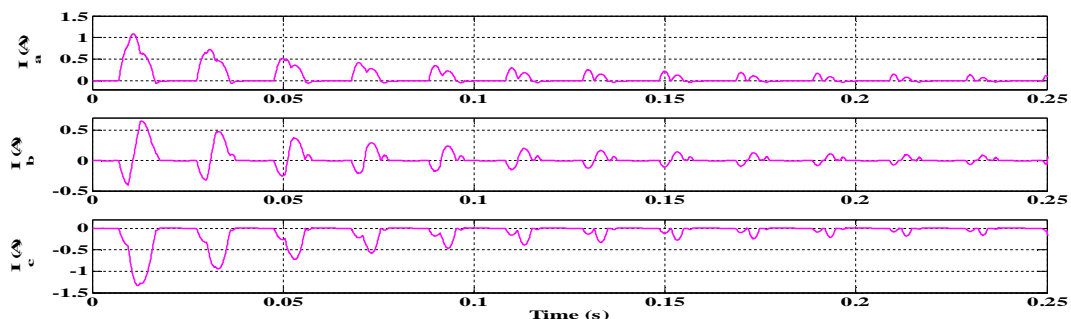

Fig.9 original Inrush Current signal

For tested power transformer, in most cases, the magnetizing inrush current had a high magnitude with longer time to decay. The Fuzzy Logic (FL) based WT trip signal remained low, indicating that the detected magnetizing inrush current was classified as non fault condition. As a result, there was no change in the status of the trip signal. The simulation results for the case of magnetizing inrush current without a load are shown in Fig. 9 and 10. The status of the trip signal (remaining low) provided an indication that the unloaded magnetizing inrush current was detected and

distinguished as a non fault current.

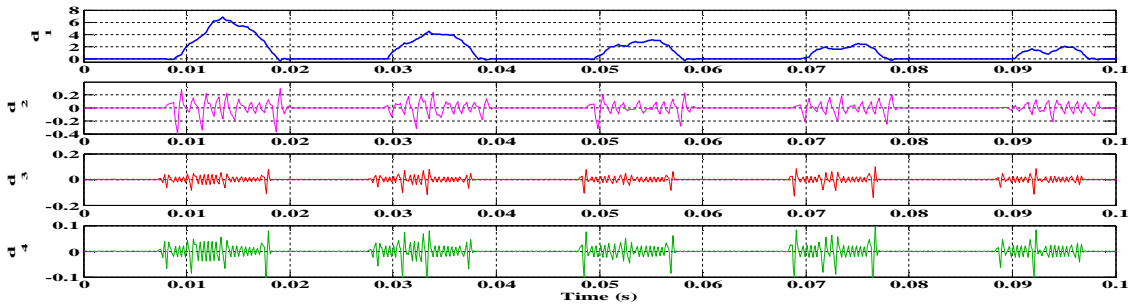

Fig.13 WT analysis of inrush current for phase-C

Figures 10, 11 and 12 show the WT Analysis of the three phases of the inrush current when an unloaded transformer is energized at 0.025Sec with a voltage closing angle of 45 degrees. The normalized amplitudes with d2 coefficients are plotted on X axis and Y axis respectively. d2 transient spikes occur at the start of the inrush current with a slow decay in a time interval of 10 cycles.

### Case 2: Single Phase-to-Ground Fault Current

The test for this fault was carried out through connecting phase A to the ground. Fig 14 and Fig15 depict the three phase differential currents and the Fuzzy Logic (FL) based WT response trip signal. It clearly shows that the ANFIS based WT trip signal changed its status from low to high indicating that an internal fault has been detected in less than five cycles. The trip signal is shown in Fig. 15.

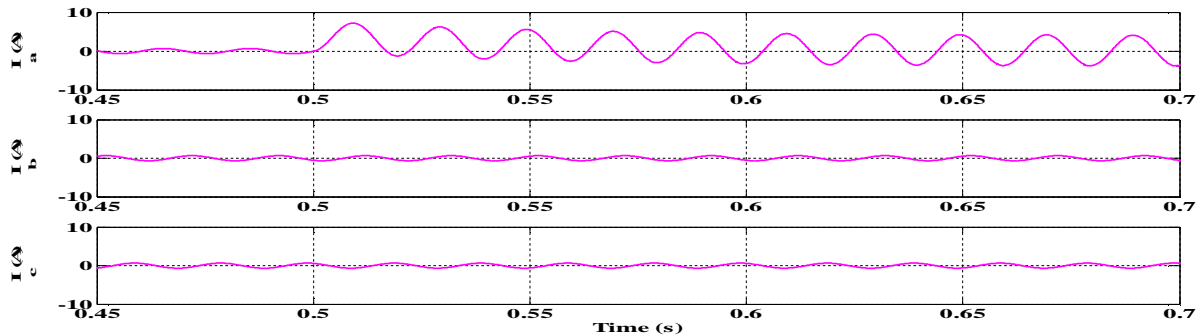

Fig.14 Line to ground Internal Fault current original signal

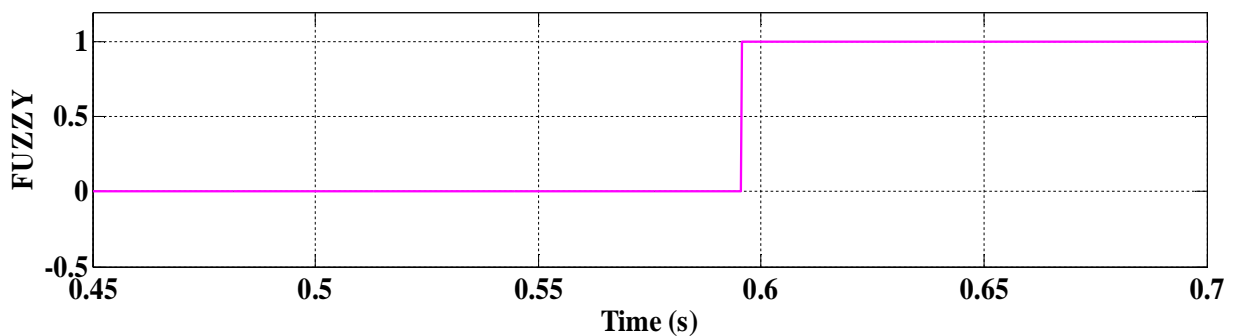

Fig.15 the responses of the Fuzzy Logic (FL)-based WT (TRIP)

Single phase A to Ground (A-G) internal fault with fault resistance of 10 ohms at 0.5 sec for duration of 0.5 sec is simulated and the WT analysis of differential current for all the three phases are shown in the Figure 16. During internal fault, transients of high frequency are generated in the current. It is observed that the occurrence of transient

spike and subsequent decay occur within three cycle.

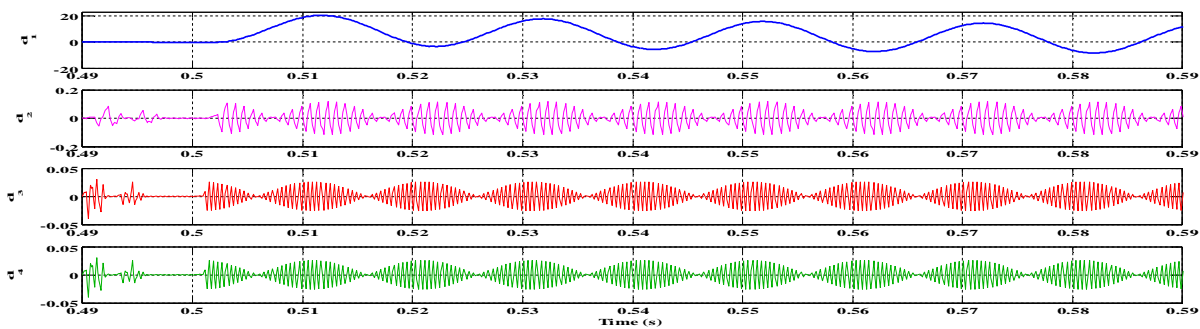

Fig. 16 WT analysis applied to Phase A Ground to internal Fault Current

It can be seen that the  $d_1$  coefficients of the Phase A, i.e. the faulty phase, is greater than the corresponding values of the healthy phase. From the results that WT based Fuzzy Logic (FL) identifies an A-G internal fault immediately after the fault has occurred. Hence, the wavelet based Fuzzy Logic (FL) relay can easily identify an A-G internal fault based on the value of the  $d_1$ ,  $d_2$ ,  $d_3$  and  $d_4$  coefficients and the nature of spikes and send a trip signal.

### Case 3: Line-to-Line Fault Current

The test for this fault was carried out through connecting phase A and phase B. Fig 17 and Fig 18 represents the three phase currents and the Fuzzy Logic (FL) including WT response of the trip signal. It clearly shows that the Fuzzy Logic (FL) based WT trip signal changed its status from low to high indicating that an internal fault has been detected in less than five cycles. The trip signal is shown in Fig. 18.

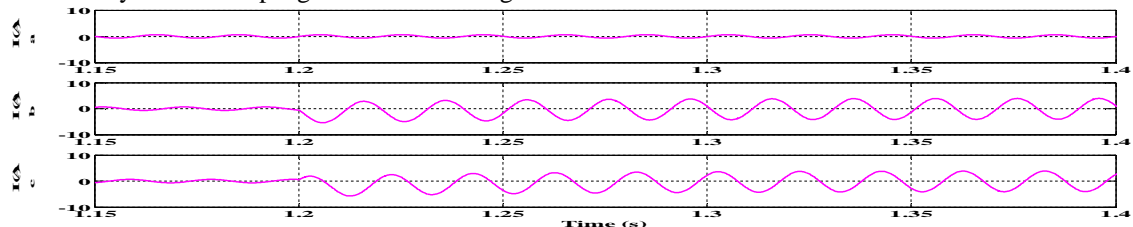

Fig.17 Double Line to ground Internal Fault current original signal

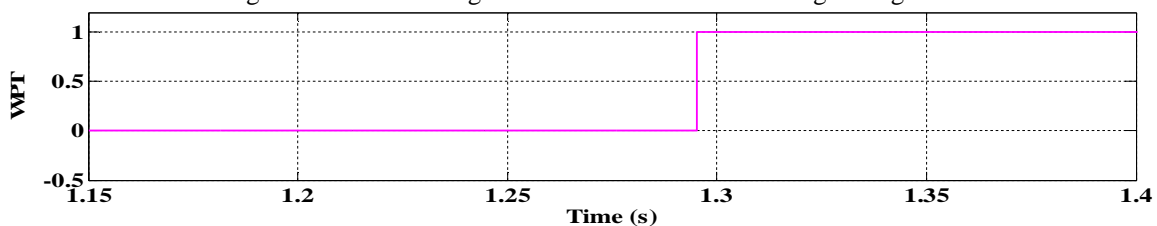

Fig.18 the responses of the Fuzzy Logic (FL)-based WT (TRIP)

Double Line to ground (AB-G) internal fault with fault resistance of 10 ohms at 0.5 sec for duration of 0.5 sec is simulated and the WT analysis of differential current for all the three phases are shown in the Figure 19. During internal fault, transients of high frequency are generated in the current. It is observed that the occurrence of transient spike and subsequent decay occur within three cycle.



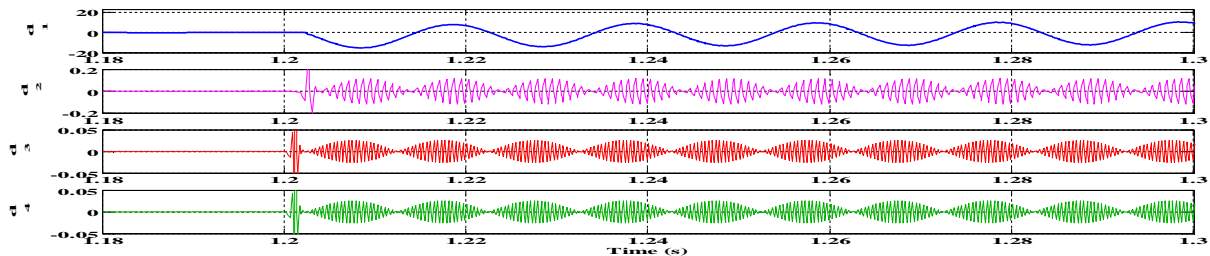

Fig.19 WT analysis of Double line to- Ground internal fault current for Phase- A

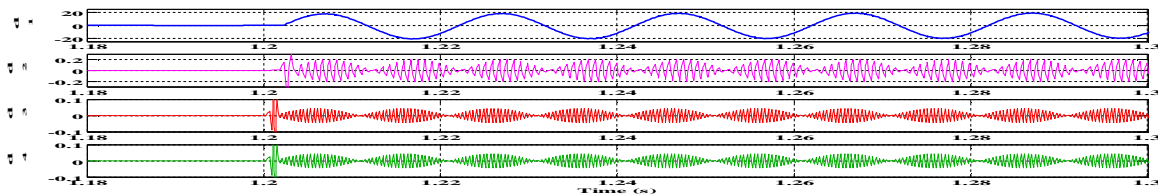

Fig.20 WT analysis of Double line to - Ground internal fault current for Phase- B

It can be seen that the d1 coefficients of the Phase A, i.e. the faulty phase, is greater than the corresponding values of the healthy phase. From the results that WT based ANFIS identifies an AB-G internal fault immediately after the fault has occurred. Hence, the wavelet based Fuzzy Logic (FL) relay can easily identify an AB-G internal fault based on the value of the d1, d2, d3 and d4 coefficients and the nature of spikes and send a trip signal.

**Case 4: three Phase fault current**

Three phase fault Current the test for this fault was carried out through connecting phase A, B and phase C. The trip signals Fuzzy Logic (FL) based WT response and the three phase differential currents are represented in Fig. 21 and Fig. 22. It clearly shows that the Fuzzy Logic (FL) based WT trip signal changed its status from low to high indicating that an internal fault has been detected in less than five cycles. The trip signal is shown in Fig. 22

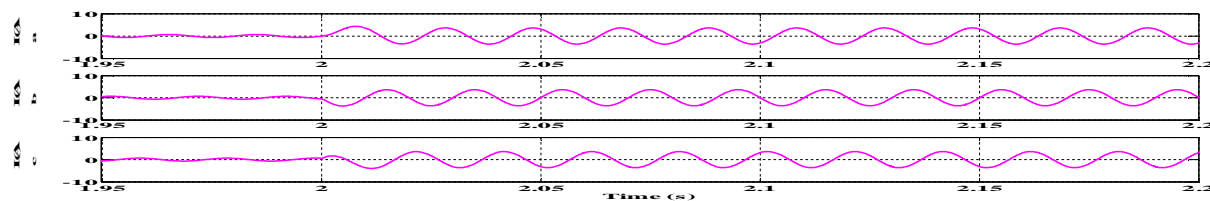

Fig.21 3-phase Internal Fault current original signal

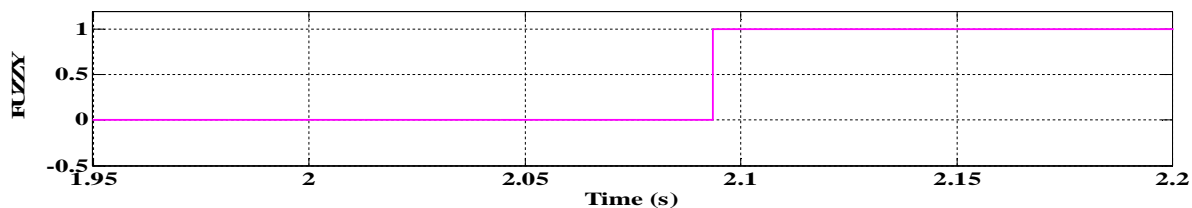

Fig.22 the responses of the Fuzzy Logic (FL) -based WT (TRIP)

Three phases to Ground internal fault with a fault resistance of 10 at 2.0 sec for 0.5sec is simulated and the WT analysis of 3 phases to Ground internal fault is shown in Figures 23, 24 and 25. It is found that the transient spikes occur immediately at the start of the fault in all the three phases and rapidly decay within a cycle and the d1 values in all the three phases are greater than the threshold

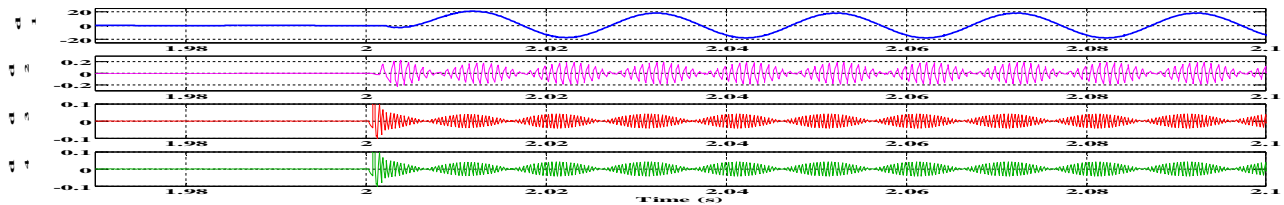

Fig.23 WT analysis of 3-phase internal fault current for Phase- A

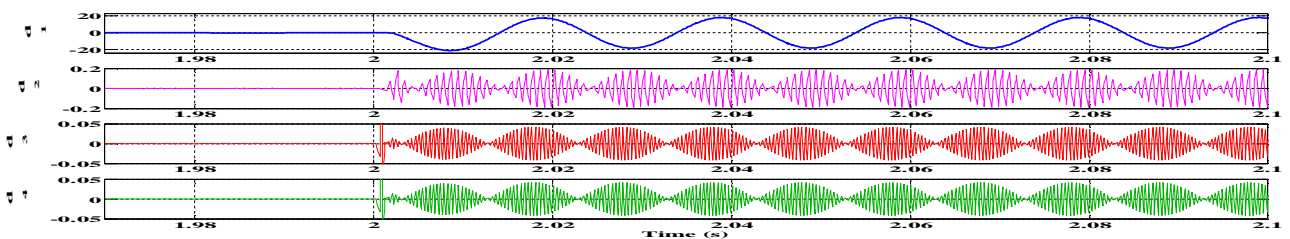

Fig.24 WT analysis of 3-phase internal fault current for Phase- B

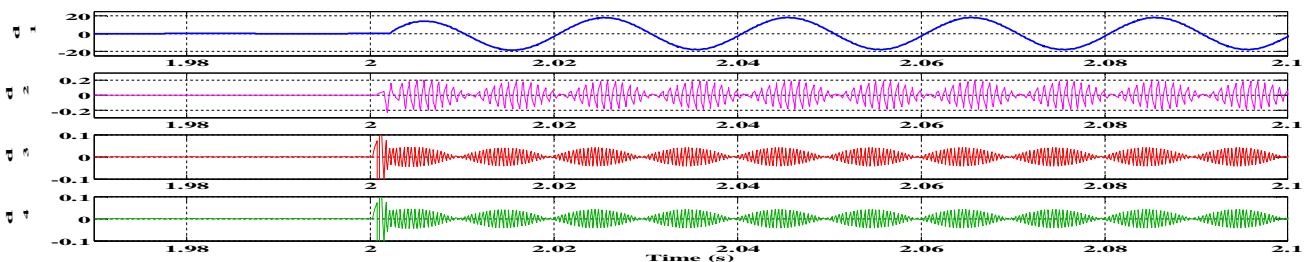

Fig.25 presents the analysis of three phase internal fault current on Phase C

It can be seen that the d1 coefficients of the Phase A, i.e. the faulty phase, is greater than the corresponding values of the healthy phase. From the results that WT based Fuzzy Logic (FL) identifies an ABC-G internal fault immediately after the fault has occurred. Hence, the wavelet based Fuzzy Logic (FL) relay can easily identify an ABC-G internal fault based on the value of the d1, d2, d3 and d4 coefficients and the nature of spikes and send a trip signal

## V. CONCLUSIONS

The Fuzzy Logic (FL) based WT is a new approach for diagnosing different types of fault currents for power-transformer differential protection is developed. The different and unpredictable characteristics of magnetizing inrush currents did not appreciably affect the ability of the Fuzzy Logic (FL) based WT differential protective relay to diagnose them as non fault currents. The proposed technique includes a new approach for Discrimination between magnetizing inrush and internal faults.

Harmonic restraint differential relay takes at least one cycle to operate for internal faults but WT identifies an internal fault immediately after the fault inception. As the d1 coefficients have valuable information about the transient nature of the signal, it can be used more effectively by giving the d1 coefficients as input for training. And moreover, the problem of large input data in Fuzzy Logic (FL) can also be reduced significantly as the number of d1 coefficients is half the number of samples in the original signal. The simulation results show fast, accurate and reliable capabilities of the Fuzzy Logic (FL) base WT to identify different types of currents flowing in a power transformer under various operating conditions.

# International Journal of Innovative Research in Science, Engineering and Technology

(An ISO 3297: 2007 Certified Organization)

Vol. 5, Issue 12, December 2016

## REFERENCES

- [1] Applied Protective Relaying, Westinghouse Electric Co., Newark, NJ, 1976.
- [2] W. H. Nichols and R. E. Cosse, Jr., "The practice of ground differential relaying," in Conf. Rec.35th IEEE IAS Annu. Meeting, 1988, pp. 21–28.
- [3] T. S. Sidhu, J. Burnworth, A. Darlington, B. Kasztenny, Y. P. Liao, G. McLaren, M. Nagpal, M. S. Sachdev, M. M. Saha, M. Swanson, and P. B. Winston, "Bibliography of relay literature, 2006 IEEE committee report," IEEE Trans. Power Del., vol. 23, no. 4, pp. 1864–1875, May 2008.
- [4] S. A. Saleh and M. A. Rahman, "Real-time testing of WPT-based protection algorithm for three-phase power transformers," IEEE Trans. Ind. Appl., vol. 41, no. 4, pp. 1125–1132, Jul./Aug. 2005.
- [5] S. A. Saleh and M. A. Rahman, "Modeling and protection of a three-phase power transformer using wavelet packet transform," IEEE Trans. Power Del., vol. 20, no. 2, pp. 1273–1282, Apr. 2005.
- [6] T. S. Sidhu and M. S. Sachdev, "Online identification of magnetizing inrush and internal faults in three-phase transformers," IEEE Trans. Power Del., vol. 7, no. 4, pp. 1885–1891, Oct. 1992.
- [7] P. E. Sutherland, "Application of transformer ground differential protection relays," IEEE Trans. Ind. Appl., vol. 36, no. 1, pp. 16–21, Jan./Feb. 2000.
- [8] B. Breitzkreutz and A. Frere, "Core balance ground fault protection of motors on a low-resistance grounded, medium-voltage system," IEEE Trans. Ind. Appl., vol. 31, no. 6, pp. 1398–1401, Nov./Dec. 1995.
- [9] C. Hayward, "Harmonic-current-restrained relays for transformer differential protection," American Institute of Electrical Engineers, Transactions of the, vol. 60, no. 6, pp. 377–382, 1941.
- [10] M. Oliveira and A. Bretas, "Application of discrete wavelet transform for differential protection of power transformers," in Power Tech, 2009 IEEE Bucharest, 2009, pp. 1–8.
- [11] A. Guzman, S. Zocholl, G. Benmouyal, and H. Altuve, "Correction to a current-based solution for transformer differential protection-part ii: relay description and evaluation," Power Delivery, IEEE Transactions on, vol. 18, no. 2, pp. 660–660, 2003.
- [12] D. Percival and A. Walden, Wavelet Methods for Time Series Analysis, ser. Cambridge series on statistical and probabilistic mathematics. Cambridge University Press, 2000.
- [13] Y. Y. Hong and C. W. Wang, "Switching detection/classification using discrete wavelet transform and self-organizing mapping network," IEEE Trans. Power Del., vol. 20, no. 2, pt. II, pp. 1662–1668, Apr. 2005.
- [14] P. Daponte, M. D. Penta, and G. Mercurio, "Transient meter: A distributed measurement system for power quality monitoring," IEEE Trans. Power Del., vol. 19, no. 2, pp. 456–463, Apr. 2004.
- [15] M. V. Ribeiro, J. M. T. Romano, and C. A. Duque, "An improved method for signal processing and compression in power quality evaluation," IEEE Trans. Power Del., vol. 19, no. 2, pp. 464–471, Apr. 2004.
- [16] T. M. Lai, L. A. Snider, E. Lo, and D. Sutanto, "High-impedance fault detection using discrete wavelet transform and frequency range and RMS conversion," IEEE Trans. Power Del., vol. 20, no. 1, pp. 397–407, Jan. 2005.
- [17] B. Kasztenny, E. Rosolowski, M. M. Saha, B. Hillstrom, "A self-organizing fuzzy logic based Protective relay- an application to power transformer protection" IEEE Transactions on Power Delivery, Vol.12, No. 3, pp.1119- 1127, July 1997.
- [18] Khorashadi-zadeh H. "Fuzzy –Neuro approach to differential protection for Power transformer", IEEE Trans. Power System, pp.279-282, 2004.
- [19] M. Geethanjali, S. Mary Raja Slochanal and R. Bhavani, "PSO-Trained ANN Based Differential Protection Scheme For Power Transformers" NEURO COMPUTING, Vol.71, pp.904- 918, 2008.
- [20] M. Geethanjali and S. Mary Raja Slochanal "A Combined Adaptive Network And Fuzzy Inference System (ANFIS) Approach For Overcurrent Relay System" Proceedings of NEURO COMPUTING, vol.7.1, pp.895-903, 2008.

## BIOGRAPHY

**Suri Babu. Miriyala** did his B.Tech JNTU. Obtained M.Tech JNTUH. He has 05 technical papers to his credit in various international and national journals and 03 conferences. His areas of interest include FACTS, Power Electronic Applications to Power Systems.

**Dr. B. V. Sanker Ram** did his B.E OU. Obtained M.Tech OU and Ph.D in 2003 from JNTU. He has 70 technical Papers to his credit in various international and national journals and conferences. He has guided 12 research scholars for Ph.D and 6 Candidates are still pursuing their research. His areas of interest include FACTS, Power Electronic Applications to Power Systems, Power Systems Reliability.