

# **Voltage and Frequency Control of Self Excited Induction Generator Feeding Stand-Alone AC Loads**

Kripa Nandakumar M<sup>1</sup>, Praveesh V V<sup>2</sup>

P.G. Student, Department of Electrical and Electronics Engineering, Vidya Engineering College, Thrissur, Kerala,  
India<sup>1</sup>

Associate Professor, Department of Electrical and Electronics Engineering, Vidya Engineering College, Thrissur,  
Kerala, India<sup>2</sup>

**ABSTRACT:** There has been a growing use of induction machines (IMs) in wind power generation schemes, particularly for supplying electrical power in remote areas. A squirrel-cage induction generator (SCIG) is preferred over Slip ring type induction generator (SRIG) due to its several advantages for stand-alone applications, such as no need for an external power supply to produce magnetic field, less maintenance, simple and rugged construction, and brushless rotor type. But the main disadvantage of squirrel-cage induction generator (SCIG) is its poor voltage and frequency for changes in rotor speed and load. This paper proposes an open-loop reactive power compensator scheme for controlling the voltage and frequency of a wind-turbine driven self-excited induction generator for low power stand-alone applications. The scheme comprises of one set of fixed capacitor bank and a parallel connected three-phase fixed frequency pulse width modulation (PWM) inverter fed from a battery connected across the stator terminals of a three-phase squirrel cage induction generator. This system inherently adapts to the changes in rotor speed or load on the generator while maintaining a near constant voltage and frequency at the load terminals. The inverter provides the necessary variable component of lagging reactive power to the induction generator so that the nominal output voltage is obtained even at lower speeds and higher loads. The DC bus voltage of the inverter is maintained using a battery. The scheme has reduced control complexity because the inverter is operated with a fixed PWM. The main advantage of the system is that it is operated in open-loop, without the need for any sensors.

**KEYWORDS:** Self Excited Induction Generator, Sinusoidal Pulse Width Modulation.

## **I. INTRODUCTION**

Owing to the increased emphasis on the global energy crisis and environmental pollution, deployment of clean and renewable energy sources such as wind or solar for power generation has assumed vital importance. In a stand-alone wind power generation system with a self-excited induction generator, it is necessary to provide a dynamically variable reactive power to maintain a constant output voltage.

### **1.1 WIND POWER**

Wind power generation is the process of conversion of wind energy into electrical energy and can be highly variable at several different timescales: hourly, daily or seasonally. Because instantaneous electrical generation and consumption must remain in balance to maintain grid stability, this variability can present substantial challenges to incorporating large amounts of wind power into a grid system. Intermittency and the non-dispatchable nature of wind energy production can raise costs of regulation. , incremental operating reserve, and (at high penetration levels) could require an increase in the already existing energy demand management, load shedding, storage solutions or system interconnection with HVDC cables. At low levels of wind penetration, fluctuation in load and allowance for failure of large generating units require reserve capacity that can also compensate for variability of wind generation. Wind power can be replaced by other power sources during low wind periods. Transmission networks must already cope with

outages of generation plant and daily challenges in electrical demand. System with large wind capacity components may need more spinning reserve.

Some of the main advantages of wind power are:

- The wind is free and with modern technology it can be captured efficiently.
- Once the wind turbine is built the energy it produces does not cause greenhouse gases or other pollutants.
- Although wind turbines can be very tall each takes up only a small plot of land. This means that the land below can be still used. This is especially the case in agricultural areas as farming can still continue.
- Many people find wind farms an interesting feature of landscape.
- Remote areas that are not connected to the electricity power grid can use wind turbines to produce their own supply.
- Wind turbines have a role to play in both the developed and third world.
- Wind turbines are available in a range of sizes which means a vast range of people and business can use them. Single households to small towns and villages can make good use of range of wind turbines available today.

Renewable energy production and demand growth is gaining momentum in many ways across the world.

There is a booming demand of wind power today and all wind energy equipment manufacturers are gearing up to meet the demand and take advantage of it. Wind power capacity growth will be reaching 447GW in the next five years and by year 2014 end, Asia will lead the world in installed wind capacity.

## 1.2 LAYOUT

The simple block diagram of wind energy conversion system (WECS) that we have implemented is as shown in Fig 1.

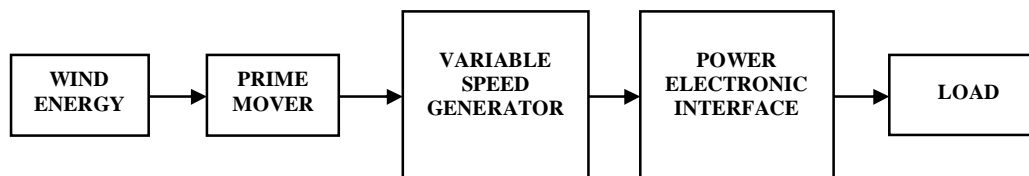

Fig 1: Block diagram representation of WECS

Wind energy conversion system (WECS) consists of a wind turbine, which converts the energy in wind into mechanical energy and an electrical generator coupled to the shaft of the turbine end converts the mechanical energy at the shaft into electrical energy at the generator output terminals. The types of turbine and generator used depend upon different factors such as the wind characteristics, size of the power plant and the nature of application.

The wind turbines can be classified according to the position of their axes as Horizontal axis wind turbines (HAWT) and Vertical axis wind turbines (VAWT). All grid connected commercial type wind turbines today are built with propeller type rotor on a horizontal axis. Power curve of such a turbine is shown in Fig 2.

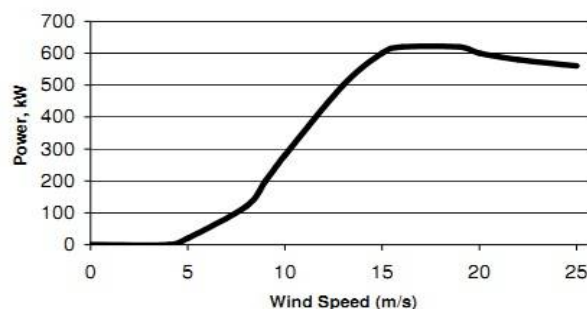

Fig 2: Power curve of a typical Danish 600kW wind turbine

The second unit of wind energy conversion system is the electrical generator. Similar to the case of turbines, different alternatives exist for generator types. Most wind turbines in the world use Induction generator to generate alternating current. Section1 contains the introduction. Section2 deals with the related work. Section3 contains modeling and analysis of SEIG. Section4 details the block diagram and principle operation of the proposed system. Section5 deals with the results and discussions.

## II. RELATED WORK

Recently, there has been a growing global use of induction machines (IMs) in wind power generation, particularly for supplying electrical power in remote areas [1]. In a stand-alone wind power generation system with a self-excited induction generator, it is necessary to provide a dynamically variable reactive power to maintain a constant output voltage. The output voltage and frequency of the stand-alone capacitor excited induction generators vary with the driving speed and load. This ac power can be used directly for certain frequency insensitive loads. But loads like computers and variable speed drives are sensitive to changes in frequency [3]. Several studies on induction generator for stand-alone applications have been reported in literature [4]. In some of the schemes, only the voltage magnitude is controllable but the frequency is not controllable, depending on the rotor speed [4-7]. Although in the frequency control was achieved through the regulation of externally applied mechanical torque. Most of these schemes use complex control strategies implemented essentially in closed-loop. One of the key issues in stand-alone system is the reliability and simplicity of control structure. Thyristor or GTO thyristor-based reactive power compensation schemes emulating variable reactive impedance [8] were used to regulate the generator terminal voltage. Poor dynamic response, harmonic currents, bulky reactor associated with magnetic saturation and losses were the drawbacks of these schemes. In order to improve the performance of the system, modern control techniques such as direct and indirect vector control have been suggested [5]. Although the use of vector control technique improves the performance of the system, overall system becomes complex with a number of sensors and intricate signal processing. Constant voltage and constant frequency operation of a stand-alone induction generator is reported in [6]. A dual winding induction generator was employed with an inverter feeding the control winding [9], while in [11] a normal induction machine with control based on instantaneous reactive power theory [12] and synchronizing templates [10] were investigated. In generalized impedance controller is used to regulate the voltage and frequency of induction generator. The frequency control of generator output was not considered in an ac-dc power interface system [13] where the generator output voltage is rectified and regulated to feed only dc loads. To feed ac loads, the scheme requires additional inverter. The excitation control composed of an ac power capacitor and a power converter connected in series. Control of generator voltage and frequency while feeding balanced/unbalanced linear or non-linear loads is reported in using composite controller with storage battery and also in [14] where three single-phase voltage source converters with a common dc link is employed. In [15], voltage and frequency control is achieved using a PWM voltage source converter with a capacitor and a chopper on the dc side. For achieving power balance, controlled was preferred over controlled dc load. However, the phase angle control of controlled ac loads leads to domination of harmonics in the system, especially when the generator power is greater than the uncontrolled load. The scheme employs dc voltage regulation by sensing the dc link voltage as the feedback parameter. This project proposes an closed-loop reactive power compensation scheme for maintaining the voltage and frequency of a self-excited induction generator feeding stand-alone a.c. loads. The closed-loop compensator adapts to the changes in rotor speed or load on the generator although it maintains a near constant voltage and frequency at the generator output terminals.

## III. ANALYSIS OF SELF-EXCITED INDUCTION GENERATOR

### 3.1 SELF-EXCITED INDUCTION GENERATOR

An induction machine can be operated as a stand-alone generator. Capacitive self- excitation of induction machine is known for many years. Self-excitation in induction machine is initiated by residual magnetism residing in the rotor core. These machines are later called self-excited induction machines. The fundamental advantage of induction machine is its ability to produce constant voltage and constant frequency output for varying speeds. In most of the cases the IM is of grid connected type in which case it takes the necessary reactive power support from the grid. But there are certain cases where the IM has to operate as stand-alone generator, in which case it requires some reactive

power for self- excitation. So we have to provide capacitors for this purpose. Another drawback of this method is its poor voltage and frequency regulation for changes in speed and load. Reactive power balance requires variable capacitance, which can be supplied with power semi-conductor circuits. Active power balance, on the other hand requires external elements to divert the excessive power from the system, when the source power exceeds the amount required by the load. Excessive power can be absorbed by the resistors connected to the rotor or stator terminals. Another drawback is that the machine demagnetizes and stops generating voltage either when wind speed falls below or the load rises beyond certain values. After that even with the wind speed at the load terminal getting back to the rated values, the induction machine cannot start working without the aid of an auxiliary energy source and a controller. The reactive power volt-ampere requirements of IG are supplied by means of VAR-generator connected to stator terminals.

The shunt capacitors may be constant or may be varied through power electronics (or step-wise). SEIGs may be built with single-phase or three-phase output and may supply alternating current (AC) loads or AC rectified (direct current [DC]) autonomous loads. We also include here SEIGs connected to the power grid through soft-starters or resistors and having capacitors at their terminals for power factor compensation (or voltage stabilization).

#### IV. PROPOSED SYSTEM CONFIGURATION

##### 4.1 BLOCK DIAGRAM DESCRIPTION

The scheme of wind turbine-driven induction generator with the proposed reactive power compensator is given in Fig 3. A squirrel-cage induction machine is used as the generator with excitation provided from two sources, one fixed capacitor bank and a parallel connected inverter. The dc bus of the inverter is supported by a battery.

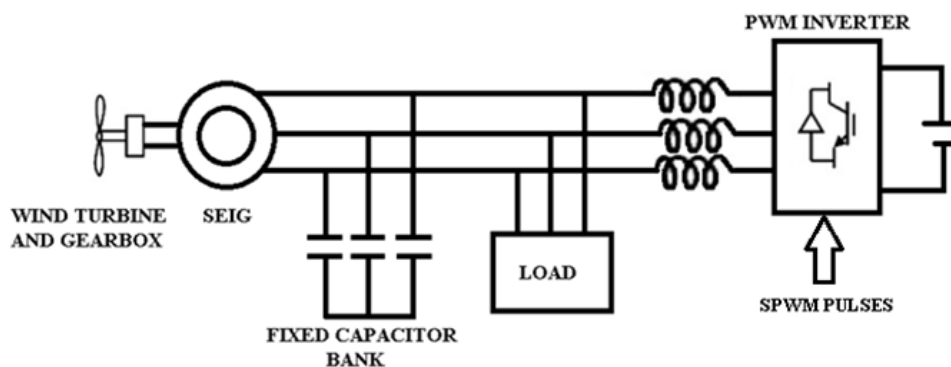

Fig 3: Proposed system configuration

The output power of the inverter is filtered by using the LC filter. The pulses to the inverter are produced by sinusoidal pulse width modulation (SPWM). The PWM pulses thus produced are used to trigger the IGBTs in the inverter. IGBTs are connected in antiparallel with the diodes. A carrier wave is compared with the reference signal corresponding to a phase to generate gating signals. The inverter here used is basically meant to supply the balance reactive power requirement of the SEIG, but it can provide real power also. If the SEIG output is less than the load requirement, then the Inverter supplies the rest. And in that case where SEIG output power is more than the load requirement, the balance amount of generated power is used to charge the battery connected at the d.c. bus of inverter. Thus the inverter acts both as an inverter and rectifier.

The inverter acts based on the voltage difference between the generator terminals and inverter terminals. Whenever the difference in voltage is large the inverter supplies more current to make the difference zero, i.e. the inverter provides the extra lagging reactive power to make the generator voltage at the constant level.

## **4.2 PRINCIPLE OF OPERATION**

In the absence of the parallel inverter, if the wind speed is above the cut-in speed but less than the nominal synchronous speed, the self-excited induction generator (SEIG) generates less than nominal voltage. This is because the fixed capacitors are chosen so as to meet the base-level excitation reactive power requirement. However, in the proposed setup, the pre-charged battery feeds the inverter that provides the necessary additional reactive power to the induction generator so as to develop the nominal voltage for lower speeds and higher loads. The lagging reactive current and the reactive power depends upon the voltage difference between the inverter output and the generated voltage of the induction machine and thus is a self-regulating mechanism considering that the dc input voltage is maintained at adequately higher levels for supplying reactive power. In addition because of the provision of the battery, the inverter is capable of supplying a limited real power also to the SEIG or/and during the sub-synchronous speeds of operation. Further, as the speed approaches the synchronous speed and increases further, the real power supplied by the inverter decreases in magnitude before becoming negative. The reactive power supplied by the inverter reduced with increase in speed because of the presence of the fixed ac capacitors. Thus the inverter contributes mainly to the balance lagging excitation reactive power needed by the generator at the given speed and load conditions. Further, as the dc bus of the inverter is connected to the battery, the inverter can exchange a limited real power also.

When the rotor speed is greater than the synchronous speed of the machine, the generator supplies real power to the load. Thereon, the inverter functions as a virtual grid, supplying only the balance reactive power to the machine, although the output voltage and frequency are maintained at near constant levels by the inverter. By maintaining the battery voltage adequately high, the inverter can be made to supply the balance reactive power needed by the machine and load combination. Thus, for wind speeds above synchronous speed, the system functions as a grid-connected wind electric generator, supplying real power to the connected load while drawing balance reactive power from the grid as needed at the particular load and speed conditions.

At a given speed, when the load increases, the generator terminal voltage tends to dip. At this instant because of the increased voltage difference, increased current is supplied by the inverter to meet the new requirement. Similarly, when the load is decreased, the terminal voltage increases and hence the current drawn from the inverter is reduced naturally. Overall, the changes in rotor speed and load primarily affects the generator terminal voltage only. An imposed constant voltage at the inverter terminals serves to provide dynamically varying reactive power compensation to the generator-load combination. Also the generator frequency is tied to the inverter output frequency which can be set constant in the firing circuit.

## **V. SIMULATION RESULTS**

The simulation results of the proposed scheme for various conditions of changes in speed and load are given below.

### **4.3.1 STEP CHANGE IN ROTOR SPEED**

The model is simulated for step changes in rotor speed keeping the load to be constant. Both step increase and step decrease in rotor speed are considered. The simulation results are given below:

**(a) Step increase in speed from 1510rpm to 1550rpm**

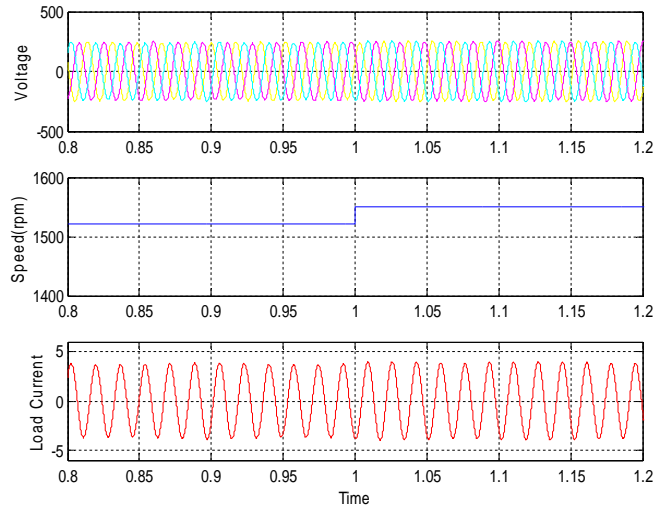

Fig 3: Step increase in speed

A step increase in rotor speed (1510rpm to 1550 rpm) is given to the SEIG at 0.5Sec of simulation. The result of the simulation is shown in Fig 3. From the diagram it is clearly seen that the magnitude of the load voltage as well as the frequency remains constant. When the rotor speed is increased it is seen that the generator current is also increased and the inverter current decreases by the same amount as the load voltage and hence the load current are maintained constant by the inverter. This shows that with increase in rotor speed, the SEIG takes more share of the load. As the speed is decreased reactive power drawn by the SEIG from the inverter is increased to make the voltage constant.

**(b) Step decrease in speed from 1550rpm to 1510rpm**

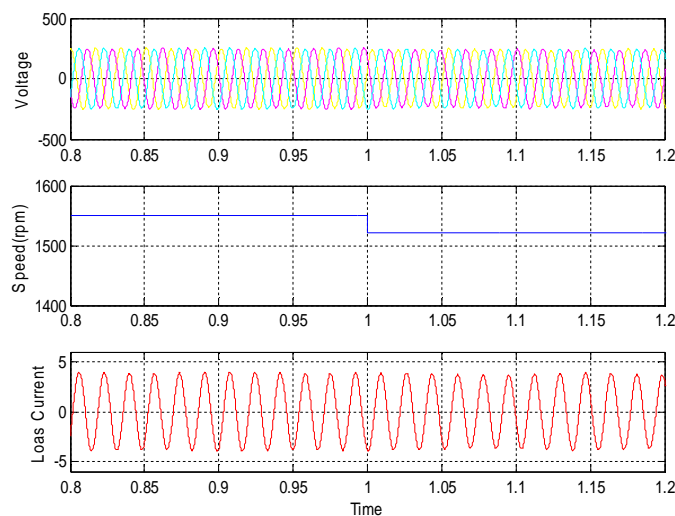

Fig 4: Step decrease in speed

A step decrease in rotor speed (1550rpm to 1510 rpm) is given to the SEIG at 0.5Sec of simulation. The result of the simulation is shown in Fig 4. From the diagram it is clearly seen that the magnitude of the load voltage as well as the frequency remains constant. When the rotor speed is decreased it is seen that the generator current is also decreased and the inverter current increases by the same amount as the load voltage and hence the load current are maintained



constant by the inverter. This shows that with decrease in rotor speed, the share of the load supplied by the SEIG is also decreased. As the speed is decreased reactive power drawn by the SEIG from the inverter is increased to make the voltage constant.

#### 4.3.2 STEP CHANGES IN LOAD

The model is simulated for step changes in load keeping the rotor speed to be constant. Both step increase and step decrease in load are considered. The simulation results are given below:

##### (a) Step increase in load from 1kW to 3.2 kW

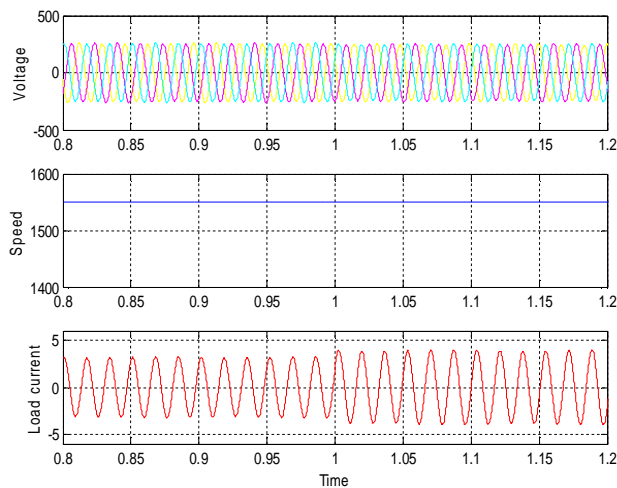

Fig 5: Step increase in load

A step increase in load from 1kW to 3.2kW is applied to the system at 1Sec of simulation keeping the rotor speed constant at 1510rpm. The result of simulation is shown in Fig 5. From the result it can be clearly seen that the load voltage and frequency is maintained at nearly constant levels unaffected by the changes in load. It can also be seen that the increase in load is shared between the inverter and SEIG.

##### (a) Step increase in load from 1kW to 3.2 kW

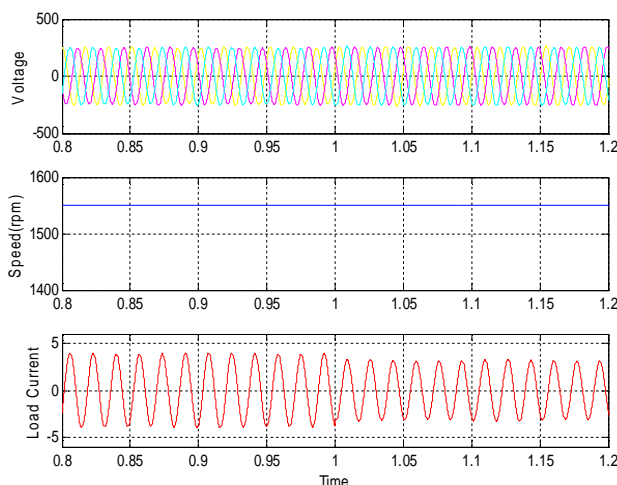

Fig 6: Step decrease in load

A step decrease in load from 3.2kW to 1kW is applied to the system at 1Sec of simulation keeping the rotor speed constant at 1510rpm. The result of simulation is shown in Fig 6. From the result it can be clearly seen that the load voltage and frequency is maintained at nearly constant levels unaffected by the changes in load. The inverter current is also decreased.

## VI. CONCLUSION

This project proposes an open-loop reactive power compensator scheme for controlling the voltage and frequency of a wind-turbine driven self-excited induction generator for low power stand-alone applications. The simulation is done for different operating conditions like step changes in rotor speed and load. This scheme inherently adapts to changes in reactive power requirement of the induction generator with changes in rotor speed or load for maintaining a near constant voltage and constant frequency at the load terminals. There is no need for any complex closed-loop control or real-time signal processing or intensive computations for switching the inverters. The experimental results indicate that the proposed scheme is a viable alternative in harnessing wind energy for low and medium power levels.

## REFERENCES

- [1] Hegde, R.K.: 'A wind driven self excited induction generator with terminal voltage controller and protection circuits'. IEEE Int. Conf. on Power Conversion, April 1993, pp. 484–489.
- [2] Murthy, S.S., Bhim, S.: 'Capacitive var controllers for induction generators for autonomous power generation'. IEEE Int. Conf. on Power Electronics, Drives and Energy Systems for Industrial Growth, January 1996, vol. 2, pp. 679–686.
- [3] Mustafa, A.A.-S., Eui-Cheol, N., Thomas, A.L.: 'Controlled shunt capacitor self-excited induction generator'. IEEE Int. Conf. on Industry Applications, October 1998, vol. 2, pp. 1486–1490.
- [4] Eduardo, S., Gustavo, B.: 'Voltage-frequency control of a self excited induction generator', IEEE Trans. Energy Convers., 1999, 14, (3), pp. 394–401.
- [5] Naidu, M., Walters, J.: 'A 4-kW 42-V induction-machine-based automotive power generation system with a diode bridge rectifier and a PWM inverter', IEEE Trans. Ind. Appl., 2003, 39, (5), pp. 1287–1293.
- [6] Seyoum, D., Rahman, M.F., Grantham, C.: 'Inverter supplied voltage control system for an isolated induction generator driven by a wind turbine'. IEEE Int. Conf. on Industry Applications, October 2003, vol. 1, pp. 568–575.
- [7] Ahmed, T., Katsumi, N., Mutsuo, N.: 'Advanced control of PWM converter with variable-speed induction generator', IET Electr. Power Appl., 2007, 1, (2), pp. 239–247.
- [8] Ojo, O., Davidson, I.E.: 'PWM-VSI inverter-assisted stand-alone dual stator winding induction generator', IEEE Trans. Ind. Appl., 2000, 36, (6), pp. 1604–1611.
- [9] Leidhold, R., Garcia, G., Valla, M.I.: 'Induction generator controller based on the instantaneous reactive power theory', IEEE Trans. Energy Convers., 2002, 17, (3), pp. 368–373.
- [10] Singh, B., Murthy, S.S., Gupta, S.: 'STATCOM-based voltage regulator for self-excited induction generator feeding nonlinear loads', IEEE Trans. Ind. Electron., 2006, 53, (5), pp. 1437–1452.
- [11] Bhim, S., Gaurav kumar, K.: 'Solid state voltage and frequency controller for a stand-alone wind power generating system', IEEE Trans. Power Electron., 2008, 23, (3), pp. 1170–1177.
- [12] Venkatesa Perumal, B., Jayanta, K.: 'Voltage and frequency control of a stand-alone brushless wind electric generation using generalized impedance controller', IEEE Trans. Energy Convers., 2008, 23, (2), pp. 632–641.
- [13] Wu, J.-C.: 'AC/DC power conversion interface for self-excited induction generator', IET Renew. Power Gener., 2009, 3, (2), pp. 144–151.
- [14] Barrado, J.A., Robert, G., Hugo, V.: 'Standalone self-excited induction generator with a three-phase four-wire active filter and energy storage system'. IEEE Int. Symp. on Industrial Electronics, June 2007, pp. 600–605.
- [15] Bhim, S., Gaurav Kumar, K.: 'Voltage and frequency controller for three-phase four-wire autonomous wind energy conversion system', IEEE Trans. Energy Convers., 2008, 23, (2), pp. 509–518.
- [16] Jayaramaiah, G.V., Fernandes, B.G.: 'Novel voltage controller for stand-alone induction generator using PWM-VSI'. IEEE Int. Conf. on Industry Applications, October 2006, vol. 1, pp. 204–208.
- [17] Marra, E.G., Pomilio, J.A.: 'Self-excited induction generator controlled by a VS-PWM bidirectional converter for rural applications', IEEE Trans. Ind. Appl., 1999, 35, (4), pp. 877–883.
- [18] Ammasaigounden, N., Subbiah, M., Krishnamurthy, M.R.: 'Wind driven self-excited pole-changing induction generators', IEE Proc., 1986, 133, pt. b, (5), pp. 315–322.
- [19] Murthy, S.S., Singh, B.P., Nagamani, C., Satyanarayana, K.V.V.: 'Studies on the use of conventional induction motors as self-excited induction generators', IEEE Trans. Energy Conversion., 1988, 3, (4), pp. 842–848.
- [20] Leonhard, W.: 'Control of electrical drives' (Springer-Verlag, Berlin, Germany, 2003, 3rd edn.)
- [21] Krause, P.C., Waszynuk, O., Sudhoff, S.D.: 'Analysis of electric machinery and drive systems' (IEEE Press, 2002)