

Modeling and Simulation of Electro-pneumatic Actuator for a VGT System

Reshma.C¹, Shyma Muhammed²

P.G. Student, Department of Electrical and Electronics Engineering, MES College of Engineering, Kuttippuram,
Kerala, India¹

Associate Professor, Department of Electrical and Electronics Engineering, MES College of Engineering,
Kuttippuram, Kerala, India²

ABSTRACT: This paper mainly focuses on detailed mathematical model for a Variable Geometry Turbocharger (VGT) pneumatic actuator controlled by an Electro-pneumatic Pressure Converter (EPC). Variable Geometry Turbocharger is an important part of the engine air path which is responsible for intake, exhaust air quality and exhaust emissions control. Electro-pneumatic actuators are widely used to control the vanes of Variable Geometry Turbochargers. Actuator is connected to the vanes of the VGT by a mechanical linkage. Electro-pneumatic actuator consists of a pressure regulator and a pneumatic actuator. Output of the pneumatic actuator is the diaphragm position hence positioning of the diaphragm controls the vanes of the VGT. A detailed nonlinear model which accurately describes different behavior at different operating points is required during engine design, for simulating the effects of actuator dynamics on the overall engine and air path performance. System model is simulated by using Simulink software.

KEYWORDS: VGT, EPC, Modeling, Electro-pneumatic actuator.

I. INTRODUCTION

The rapidly progressing environment of the automotive industry demands accuracy in control of the mechatronic systems used in the vehicles. Such systems include electro-pneumatic actuators which are commonly used in exhaust gas recirculation, air brake systems and turbocharger applications. A physical model based control strategy helps in enhancing engine performance. This paper presents the modeling of an electro-pneumatic actuator used in the variable geometry turbocharger (VGT) system. The electro-pneumatic actuator is composed by an electro-pneumatic pressure converter (EPC) coupled to a pneumatic actuator. Pneumatic actuators are commonly used in high power positioning applications in automobile systems, such as turbocharger control (waste-gate and VGT), exhaust gas recirculation (EGR), and variable intake manifolds [1]. Although not as precise as electric motors [2] they have the advantages of high power-to-size ratio, low maintenance cost, light weight, and the availability of pneumatic sources in the engine. These advantages come at the price of more friction and nonlinearity due to air compressibility. In presence of these traditional drawbacks, precise and robust control strategies are required to use pneumatic actuators effectively.

The position of the pneumatic actuator diaphragm is controlled by using the EPC to vary the pressure in one chamber, while the pressure in the second chamber is kept constant. A similar method of controlling the pressure in a chamber (single acting actuator) has been discussed in [3]. Another method of position control of pneumatic actuators by varying the pressure in both chamber (double acting pneumatic actuator) is discussed in [4]. Different physical models of the electro-pneumatic actuators exist, which model the pneumatic actuator for VGT vanes position via a pressure regulator. The input voltage to these regulators is normally expressed as the percentage duty cycle, since actuators are usually energized using pulse width modulation. A model with pressure variation due to air mass flow to the pneumatic actuator chamber is presented in [5]. A double acting pneumatic actuator model is presented with the consideration that pressure also varies due to change in volume of pneumatic actuator is presented in [6]. A pneumatic actuator model

with considering the variation in pressure due to mass flow, temperature and volume is discussed in [7]. In [8] air mass inside the chamber and its variation is fitted as a function upstream and downstream pressure.

In this paper a complete non-linear model of an electro-pneumatic actuator has been presented where input to the system is PWM input and the output of diaphragm position has been controlling. The proportional valve uses a damper or a spring and its advantage over conventional ON/OFF solenoid valve is that it can attain more than two positions with different input voltages. The EPC used in the VGT actuator has mixed characteristics. It has a spring and damper mechanism but without air pressure it acts as an ON/OFF solenoid valve. The reason for this mixed design is that in the pressure converter, the force due to air pressure plays a significant role. The second part of the system is a single acting pneumatic actuator. It can be modeled as a spring damper mechanism with input as pressure difference across both the chambers of pneumatic actuator

Paper is organized as follows, Section II describes about the overall VGT electro-pneumatic system. Physical model of the system has described in Section III. Section IV presents model validation. Section V concludes the paper.

II. SYSTEM DESCRIPTION

Figure.1 shows the schematic diagram of an electro-pneumatic actuator for a variable geometry turbocharger system. Electro-pneumatic VGT actuation systems generally comprise of two sub systems, a linear pneumatic actuator and an electromagnetic system which regulates the pressure inside the pneumatic actuator, to control its position.

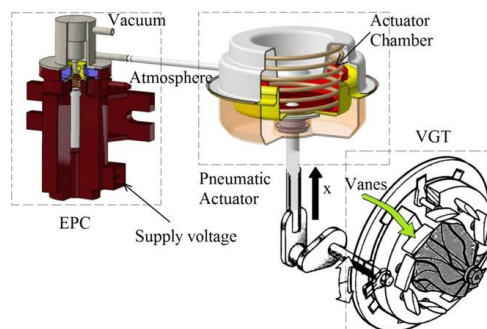
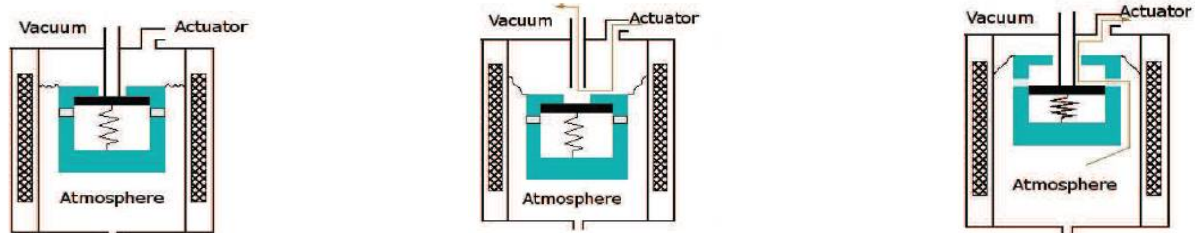

Fig. 1. A complete system with EPC, pneumatic actuator and VGT

The pneumatic actuator is a single acting actuator which is connected to a pressure regulator or Electro-pneumatic Pressure Converter (EPC) through a pneumatic line, and to the unison ring of the VGT via a mechanical linkage. It consists of a diaphragm which is connected to the VGT's vanes through this linkage. The diaphragm along with a membrane splits the inner space of the actuator into two chambers. The solenoid EPC connects the pneumatic actuator chamber with a source reservoir (vacuum) when it is energized, and to the atmosphere when it is de-energized. Figure 2 shows different stages of electro-pneumatic actuator.



(a) EPC in equilibrium

Fig 2 Different stages of EPC
(b) Magnetic force is applied

(c) Magnetic force is removed

The pressure difference so obtained inside the two actuator chambers results in diaphragm motion. The actuator stem linking the diaphragm with the VGT vanes hence moves the vanes to vary the turbine geometry. The spring action

inside the pneumatic actuator brings the vanes back to their original position. The diaphragm inside the pneumatic actuator moves in response to the pressure difference created inside the chamber. The pneumatic actuator controls the VGT vanes position. The EPC controls the pressure on the other side of the diaphragm. The diaphragm is connected to the vanes of the VGT through a linear linkage. The linkage moves a crank in the VGT to which the vanes are connected. The crank turns the vanes all together and hence, varies the amount of the exhaust gas reaching the impeller of the turbocharger's turbine.

III. SYSTEM MODELING

A detailed nonlinear model which accurately describes different behavior at different operating points is required during engine design, for simulating the effects of actuator dynamics on the overall engine and air path performance. While in the modeling the pressure dynamics in the pneumatic actuator are considered by taking into account the compressible flow equation along with pressure and temperature losses in the pneumatic lines. Both the system (i.e. electro-pneumatic pressure converter and the pneumatic actuator) are combined together to obtain a base model of an electro-pneumatic actuator. Figure 3 shows the block diagram representation of the complete VGT system containing EPC and pneumatic actuator.

1) Electro-pneumatic Pressure Converter Modeling :

The EPC is a solenoid that converts magnetic force into mechanical motion of the plunger.

- In the equilibrium position actuator port is neither connected to supply vacuum nor to atmosphere.
- When plunger moves down due to magnetic force between actuator port and supply port (vacuum) is formed.
- When applied signal is removed plunger moves up due to pressure difference and forms a connection between actuator chamber and atmosphere.

The equivalent electrical circuit of the EPC is a current carrying wire with resistance R_i and variable inductance L ; dependent on plunger position shown in figure 4

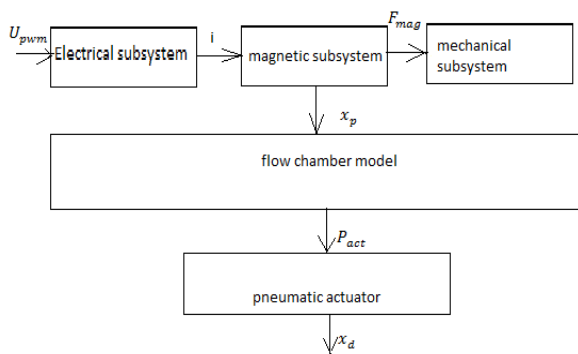

Fig.3 Block diagram of the complete VGT system containing an EPC and a pneumatic actuator

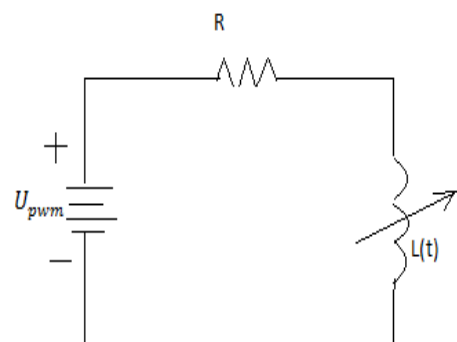

Fig. 4 Equivalent circuit diagram of EPC.

From Kirchoff's voltage law, the equation of the electric circuit can be written as ,

$$U_{pwm} = R_i + L \frac{di}{dt} + i \frac{dL}{dt} \tag{1}$$

Equation for magnetic force :

$$F_{mag} = \frac{B^2 A}{2\mu_0} \quad (2)$$

Mechanical equation for the plunger :

The mechanical equation of the plunger can be written as a sum of all the forces acting on it

$$m_p \ddot{x}_p = F_{atm} - F_{res} - F_{act} - F_{mem} - F_{mag} - b_p \dot{x}_p - F_s^* \quad (3)$$

Where

m_p =plunger mass

b_p =damping constant

F_{act} =force on the plunger due to pressure within the actuator chamber.

F_s^* =spring force act when plunger is displaced.

F_{mem} =force due to elasticity of membrane

K_{s1}^* = stiffness constant

2) Equation for air mass flow :

Air mass flow can be modeled as air passing through the duct towards the actuator. A path is formed between actuator chamber and reservoir when the plunger moves down due to magnetic force and the air flows from the actuator to

vaccum reservoir($\dot{m}_{act-out}$)

$$\dot{m}_{act-out} = A_{eff(act-res)} P_{act} \sqrt{\frac{\gamma}{RT_{act}}} \phi\left(\frac{P_{res}}{P_{act}}\right) \quad (4)$$

The air path between actuator chamber and atmosphere is attained when magnetic force is removed. \dot{m}_{act-in} flows from atmosphere to actuator chamber.

$$\dot{m}_{act-in} = A_{eff(atm-act)} P_{atm} \sqrt{\frac{\gamma}{RT_{atm}}} \phi\left(\frac{P_{act}}{P_{atm}}\right) \quad (5)$$

Where

A_{eff} =effective flow area.

P_{act} =actuator pressure.

T_{act} =actuator temperature.

γ =specific heat at constant volume.

2) Pneumatic actuator model:

The pneumatic actuator consists of a linear linkage shaft that is connected to a diaphragm. The diaphragm divides the internal actuator space into two chambers via a membrane. Pressure difference in the chambers moves the diaphragm and the linkage linearly. This motion is converted into a rotary motion via a rotating unison ring in the VGT that

actuates all VGT vanes together. These guided vanes regulate exhaust gas flow to the turbocharger. The mechanical subsystem for the diaphragm can be modeled as a mass spring and damper system. Applied force to the diaphragm is pressure difference between actuator chambers. Using Newton's second law of motion

Mechanical sub system can be modeled as a mass, spring and damper system,

$$m_d \ddot{x}_d = F_{act} - b_d \dot{x}_d - F_s - F_f \quad (6)$$

Where m_d = mass of diaphragm

b_d = diaphragm position

F_s = sum of pre-compressed spring force.

K_{sm} = spring constant

Actuator pressure model :

Pressure inside the actuator chamber can be determined from the air mass flow entering or leaving the actuator, and the variation in volume of the chamber due to diaphragm movement. A flow model can be obtained with following assumptions.

- Air is a perfect gas
- Pressure is homogeneously distributed throughout the chamber
- Process is isothermal hence, temperature inside the actuator chamber is considered as constant. No heat loss occurs from the walls of the actuator
- There is no leakage flow from the walls of the actuator

Pressure inside the actuator chamber can be modelled from the air mass flow equation entering or leaving the actuator chamber

$$\frac{dP_{act}}{dt} = \frac{RT}{V} \frac{dm}{dt} + \frac{mR}{V} \frac{dT}{dt} + mRT \frac{d}{dt} \left(\frac{1}{V} \right) \quad (7)$$

Volume of actuator chamber :

The volume of the actuator chamber varies with the change in position of the diaphragm. Let us consider the actuator chamber as a cylinder with initial volume V_0 . The volume of the chamber reduces as the diaphragm moves from its initial position. The displaced volume depends on the diaphragm position x_d and diaphragm disk area A_d .

Volume of the actuator chamber varies with the change in position of the diaphragm

$$V_{act} = V_0 - A_d x_d \quad (8)$$

$$\dot{V}_{act} = -A_d \dot{x}_d \quad (9)$$

Temperature of actuator chamber :

Temperature inside the actuator chamber varies due to the energy flowing from the atmosphere to the actuator or from actuator to reservoir.

$$\frac{dE}{dt} + \frac{d}{dt}(W_x) = \frac{d}{dt}Q + \dot{H}_{in} - \dot{H}_{out} \quad (10)$$

Substitute caloric equations in to (10)

$$\frac{d}{dt}[m_{act}c_vT_{act}] = -\frac{d}{dt}[W_x] + \dot{m}_{act-in}[(c_v + R)T_{atm}] - \dot{m}_{act-out}[(c_v + R)T_{act}] \quad (11)$$

$$\frac{d}{dt}[m_{act}c_vT_{act}] = c_v\dot{T}_{act}m_{act} + c_vT_{act}\dot{m}_{act-in} - c_vT_{act}\dot{m}_{act-out} \quad (12)$$

Mechanical work done by the actuator diaphragm is the product of pressure inside the pneumatic actuator and the change in volume of the actuator chamber

$$W_x = P_{act}V_{act} \quad (13)$$

$$\frac{d}{dt}(W_x) = P_{act}\frac{d}{dt}V_{act} \quad (14)$$

$$c_vT_{act}\dot{m}_{act} + \dot{m}_{act}c_vT_{act}\dot{m}_{act-in} = -P_{act}\dot{V}_{act} + (c_v + RT_{atm})\dot{m}_{act-in} - RT_{act}\dot{m}_{act-out} \quad (15)$$

$$P_{act}\dot{V}_{act} = \frac{m_{act}RT_{act}}{V_0 - A_d x_d}(-A_d \dot{x}_d) \quad (16)$$

From equation (12) \dot{T}_{act}

$$\dot{T}_{act} = T_{act} \left[\frac{(\gamma - 1)A_d \dot{x}_d}{V_0 - A_d x_d} \right] + [\gamma T_{atm} - T_{act}] \frac{\dot{m}_{act-in}}{m_{act}} - [(\gamma - 1)T_{act}] \frac{\dot{m}_{act-out}}{m_{act}} \quad (17)$$

Pressure dynamics ,

$$\dot{P}_{act} = \frac{RT}{V}m_{act} + \frac{\dot{m}_{act}}{V}RT_{act} + mRT \frac{d}{dt} \left(\frac{1}{V} \right) \quad (18)$$

$$\dot{P}_{act} = \frac{RT_{act}}{V_{act}}\dot{m}_{act-in} - \frac{RT_{act}}{V_{act}}\dot{m}_{act-out} + \frac{P_{act}}{V_{act}}\dot{V}_{act} + \frac{m_{act}}{V_{act}} \left[T_{act} \left(\frac{(\gamma - 1)A_d \dot{x}_d}{(V_0 - A_d x_d)} \right) + (\gamma T_{atm} - T_{act}) \frac{\dot{m}_{act-in}}{m_{act}} - ((\gamma - 1)T_{act}) \frac{\dot{m}_{act-out}}{m_{act}} \right] \quad (19)$$

$$\dot{P}_{act} = \frac{\gamma R}{V_0 - A_d x_d} (T_{atm} \dot{m}_{act-in} - T \dot{m}_{act-out}) - \frac{\gamma P_{act}}{V_0 - A_d x_d} A_d \dot{x}_d \quad (20)$$

$$\gamma = \frac{c_v + R}{c_v}$$

From eqns (1), (3), (4), (5), (6), (9), (17) and (20) the state equations can be written as

$$\begin{aligned} \dot{x}_1 &= x_2 \\ \dot{x}_2 &= P_{act} \frac{A_{act}}{m_p} - \frac{K_{mem}}{m_p} x_1 - \frac{b_p}{m_p} x_2 - k_{s1} x_1 \\ \dot{x}_3 &= x_4 \\ \dot{x}_4 &= P_{act} \frac{A_{act}}{m_d} - \frac{F_s}{m_d} - \frac{b_d}{m_d} x_4 - \frac{F_f}{m_d} \\ \dot{x}_5 &= x_5 \left[\frac{(\gamma - 1) A_d x_4}{V_0 - A_d x_3} \right] - [\gamma T_{atm} - x_5] \frac{\dot{m}_{act-in}}{m_{act}} - (x_5 \gamma - x_5) \frac{\dot{m}_{act-out}}{m_{act}} \\ \dot{x}_6 &= \frac{\gamma R x_5}{V_0 - A_d x_3} m_{act} - \frac{\gamma x_6}{V_0 - A_d x_3} A_d x_4 \\ \dot{x}_7 &= \chi_{in}(x, t) A_{eff}(atm - act) P_{atm} \sqrt{\frac{\gamma}{RT_{atm}}} \phi\left(\frac{x_6}{P_{atm}}\right) - \chi_{out}(x, t) A_{eff}(act - res) x_6 \sqrt{\frac{\gamma}{R x_5}} \phi\left(\frac{P_{res}}{x_6}\right) \end{aligned}$$

Where

- x_1 =plunger position
- x_2 =plunger velocity
- x_3 =diaphragm position
- x_4 =diaphragm velocity
- x_5 =temperature inside the actuator
- x_6 =pressure inside the actuator
- x_7 = air mass inside the actuator chamber.

And the output is the diaphragm position x_d which has to be controlled with respect to PWM input.

Using these state equations we have validated the system in next section.

IV. SIMULATION RESULTS

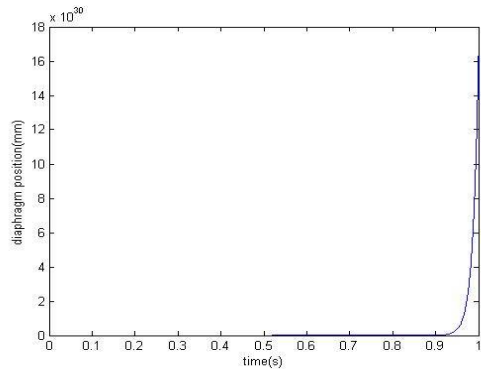

Fig.5 Response of diaphragm position

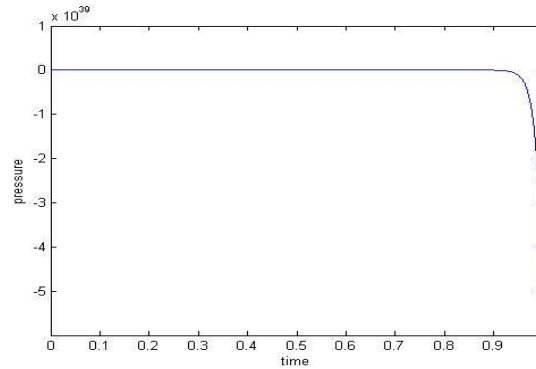

Fig.6 Response of pressure inside the actuator chamber

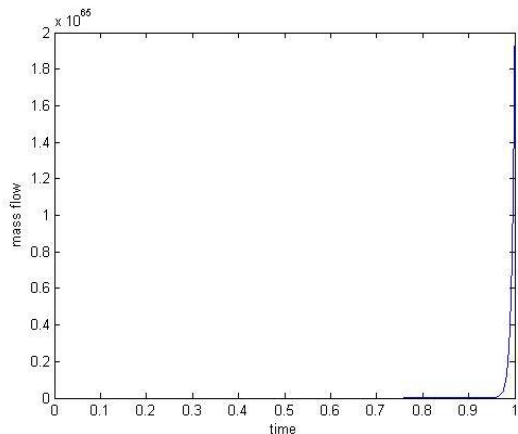

Fig.7 mass flow inside the actuator chamber

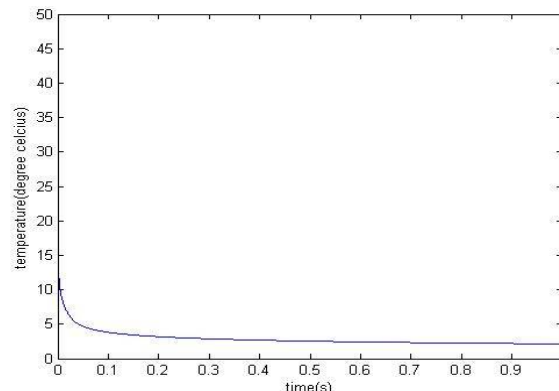

Fig 8. Temperature inside the chamber

Using these state equations we have validated the system response and from the system response it is inferred that system is an unstable system.

V. CONCLUSION

This paper focuses on the non-linear modeling of the VGT electro-pneumatic actuator system. Detailed non-linear modeling is performed by considering the dynamics in the pressure, air mass flow and temperature. The pressure dynamics inside the actuator chamber are modeled by taking into account the variation of mass, temperature and volume. The model so obtained is validated using Simulink and also model so describes electro-mechanical phenomena inside the actuator. From the model validation it is inferred that the system is an unstable system. Advanced non-linear controllers can be used to controlling the diaphragm position.

REFERENCES

[1] J. Erjavic. *Automotive Technology a Systems Approach*. Albany, NY, USA: Delmar, 2010.
[2] M. di Bernardo, A. di Gaeta, C. I. Hoyos Velasco, and S. Santini, "Energy-based key-on control of a double magnet electromechanical valve actuator," *IEEE Trans. Control Syst. Technol.*, vol. 20, no. 5, pp. 1133–1145, Sep. 2012

International Journal of Innovative Research in Science, Engineering and Technology

An ISO 3297: 2007 Certified Organization

Volume 5, Special Issue 5, April 2016

International Conference on Emerging Trends in Smart Grid Technology - INCETS'16

Organized by

Dept. of EEE, College of Engineering, Trikaripur (CAPE, Government of Kerala), Cheemeni, Kasaragod, Kerala-671313, India

- [3] J. Galindo, H. Climent, C. Guardiola, J. Domenech, "Modeling the vacuum circuit of a pneumatic valve system", *Journal of Dynamic Systems Measurement and Control* .vol.131, no. 3, pp. ,Mar 2009
- [4] S. Laghrouche, M. Smaoui, F. Plestan, X. Brun, "Higher order sliding mode control based on optimal approach of an electropneumatic actuator", *International Journal of Control* , vol. 79, no.2 , pp. 119–131,Dec 2005
- [5] R.B. van Verseveld, G.M. Bone, "Accurate position control of pneumatic actuator using on/off solenoid valves", *IEEE/ASME Transactions on Mechatronics* , vol. 3 , no.2 ,Sep 1997
- [6] E. Topcu, I. Yuksel, Z. Kamis, "Development of electro-pneumatic fast switching valve and investigation of its characteristics", *Mechatronics* , vol . 16, no.4 , pp. 365–378 , Dec.2006
- [7] P.E. Moraal, I.V. Kolmanovsky, M.J. Nieuwstadt, "Modeling and identification of a current to vacuum transducer and vnt actuator", *International Conference on Advanced Intelligent Mechatronics*, Atlanta, USA, Mar.1999
- [8] Salah Laghrouche, Fayez Shakil Ahmed, and Adeel Mehmood, "Pressure and Friction Observer-Based Backstepping Control for a VGT Pneumatic Actuator" *IEEE Trans. Control Syst. Technol.*, vol. 22, no. 2, pp.456-467 , Mar. 2014
- [9] Z. Rao, G. Bone, "Nonlinear modeling and control of servo pneumatic actuators", *IEEE Transactions on Control Systems Technology* vol.16, no.3, pp. 562–569 , Mar.2008
- [10] A. Kotwicki, J. Russell, "Vacuum egr valve actuator model", *International Fuels & Lubricants Meeting & Exposition*, vol. 107, no.4 , pp. Jun. 1998
- [11] Z. Rao, G. Bone, "Nonlinear modeling and control of servo pneumatic actuators", *IEEE Trans. Control Syst. technol.*, vol.16, no. 3 , pp. 562–569 ,Jan 2008.
- [12] A. Mehmood, S. Laghrouche, and M. El Bagdouri, "Nonlinear modeling of electro-pneumatic actuator for variable nozzle turbocharger control," in *Proc. 49th IEEE Conf. Decision Control*, Dec. 2010, pp. 3517–3522
- [13] A. Robertsson, A. Shiriaev, & R. Johansson, "Friction compensation for nonlinear systems based on the LuGre model," *Proc. of the 6th Symposium on Nonlinear Control Systems*, pp. 1439-1444, Stuttgart, Germany, 2000
- [14] Moraal, P., Kolmanovsky, I. and Nieuwstadt, M "Modeling and identification of a current to vacuum transducer and VNT actuator" *Int. Conf. Advanced Intelligent Mechatronics*, Atlanta, USA,1999
- [15] Mehmood, A., Laghrouche, S. and El Bagdouri, M. "Modeling identification and simulation of pneumatic actuator for VGT system" *Sensors and Actuators: A Physical*, vol. 168 pp.367–378, Mar 2011