

Design and Development of Windmill Operated Water Pump

Ronak D Gandhi¹, Debarshi Sharma², Bhushan Kumbhare³, Shubham Choukade⁴

BE Student, Department of Mechanical Engineering, MIT Academy of Engineering, Alandi, Maharashtra, India¹

BE Student, Department of Mechanical Engineering, MIT Academy of Engineering, Alandi, Maharashtra, India²

BE Student, Department of Mechanical Engineering, MIT Academy of Engineering, Alandi, Maharashtra, India³

BE Student, Department of Mechanical Engineering, MIT Academy of Engineering, Alandi, Maharashtra, India⁴

ABSTRACT: The imminent exhaustion of fossil energy sources, spreading global warming, expanding greenhouse effect, higher need of energy, less availability of power supplies motivates us to use renewable source of energy like wind-energy which is most prominent for our suitable application. Small wind turbines need to be cost effective, loyal, affordable minimum maintenance cost for any average person. It produces costlier electricity than medium and large scaled wind mills, specially in areas where availability of wind sites are less and in self-governing applications. However, after perfectly sized and used at optimal working climate, small-scale wind mills could be a dependable energy source and produce socio-economically valuable energy not only in developing countries but also in local applications. The small-scaled wind mills have different aerodynamic behaviour than their large-scale wind mills. Poor performance of small wind mills is due to laminar separation and in turns on the rotor blades because of low Reynolds number (Re) resulting from low wind speeds and small rotor capacity. Low Reynolds number airfoils permits starting at lower wind velocity, increasing the starting torque and thus improving the overall performance of the turbine. Designing of rotor of windmill will include optimizing the rotor and its components to achieve maximum power coefficient and efficiency. The pitch twist and allotment of chord length are optimized based on conservation of angular momentum and theory of aerodynamic forces on an airfoil. Blade Element Momentum (BEM) theory is first derived then used to conduct a parametric study that will determine if the optimized values of blade pitch and chord length create the most efficient blade geometry.

KEYWORDS: Wind energy, wind mill, rotor, blade design, power coefficient.

I. INTRODUCTION

Water pumping is very important, most basic wide-spread energy needs in rural areas of the world. It has been found that more than half the world's rural population does not have approach to clean water supply [1]. Water supplies like wells, dugouts, rivers can often be used for agricultural fields. However, due to limited availability of power supplies or resources some alternate form of energy has to be used to supply water from the source to a point of consumption. Wind energy is an important source of renewable energy that can be used for pumping water in remote locations. A wind pump is nothing but a windmill used for pumping water, either as a source of fresh water or wells. It is one of the earliest methods of utilizing the energy of the wind to pump water.

Popular renewable energy sources making an expandable contribution to the energy supplies in view of encouraging renewable energy sources endowments, limitations and unpredictably supply of fossil fuel, and rise in pressure in environment due to generation of conventional energy. Among the renewable energy resources, the generation of electrical energy & mechanical energy by wind mills has emerged as a feasible and cost-effective option.

With the rise in understanding of global warming due to Carbon Dioxide produced by burning of fuels, the use of natural energy resource is coming into picture. Now a day people are started using of natural sources like wind, hydro,

International Journal of Innovative Research in Science, Engineering and Technology

(A High Impact Factor, Monthly Peer Reviewed Journal)

Vol. 5, Issue 1, Januray 2016

solar energy to produce electricity and providing power to the various power-plants. The use of wind mills is one of the most popular methods of using the energy from natural sources. Windmills were used in earlier days to run the pump & pumping the water from the well. Wind mills are not used because they mostly depend on the wind blowing . however, a small scale wind mills can be used to power small home appliances by decreasing the electricity cost and quantity of fuel burnt to produce equal amount of electricity.

Wind mills utilize energy from the wind to produce electricity. A typical system in an disclosed site could easily genrate more power than household lamps and other use of electrical appliances [3] . Just like any engineering design posses challenges, household wind turbine also posses various challenges such as noise, aesthetics, purchasing cost, repair cost etc.

This research paper explain idea about the current designs of the small scale wind mills along with the market requirement followed by the design of an innovative wind mills system. In this research paper focussed areas such as current designs, power generation, blade design power saving and fail safe methods are taken into consideration. The paper also considers the development difficulty limiting the design enhancement such as noise, aesthetics, material cost, maintenance, and other issues. These are the problems which may affect the design, manufacturing and marketing of the product. This report also elaborates the design and development of such a wind turbine blade profile for domestic application by comparison with various profiles. This research is used for producing electricity at low wind speeds which can be used to power the lighting requirements of a house.

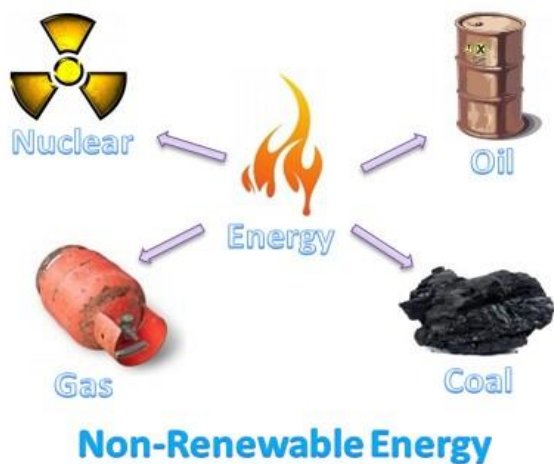

Figure No 1: Sources Of Energy

A. Objectives-

- To built up small scale wind turbine & to see (study) feasibility of it.
- To Reduce weight and cost .
- To design & develop water pump which will cope up with ordinary pump.

B. Need-

- Growing awareness of rising levels of greenhouse gases
- Global warming
- Increasing prices of fossil fuels
- Limited power supplies .

International Journal of Innovative Research in Science, Engineering and Technology

(A High Impact Factor, Monthly Peer Reviewed Journal)

Vol. 5, Issue 1, Januray 2016

- Increasing dependency on renewable energy than non renewable source of energy.



Figure No 2: Renewable Energy

C. Scope Of Project

- Cascading of Solar and Wind energy for running specific application like waterpump etc.
- Wind energy can be used for electricity or power generation.
- Efficiency or power output of pump can be improved by optimizing blade parameters such as blade thickness ,blade length , blade profile , number of blades etc.

D. Methodology

- ❖ Analytical study
 - Research Papers
 - Formulas
 - Empirical Relations
- ❖ Design of small wind turbine blades
 - Blade angle
 - Blade height
 - Blade thickness
 - Blade length
- ❖ Experimentation with small wind turbines .
- ❖ Measure velocity , power , discharge , torque , head etc.
- ❖ Use the energy produced from small wind turbines for suitable application like pumping water etc.

International Journal of Innovative Research in Science, Engineering and Technology

(A High Impact Factor, Monthly Peer Reviewed Journal)

Vol. 5, Issue 1, Januray 2016

E. Concept Of The Project

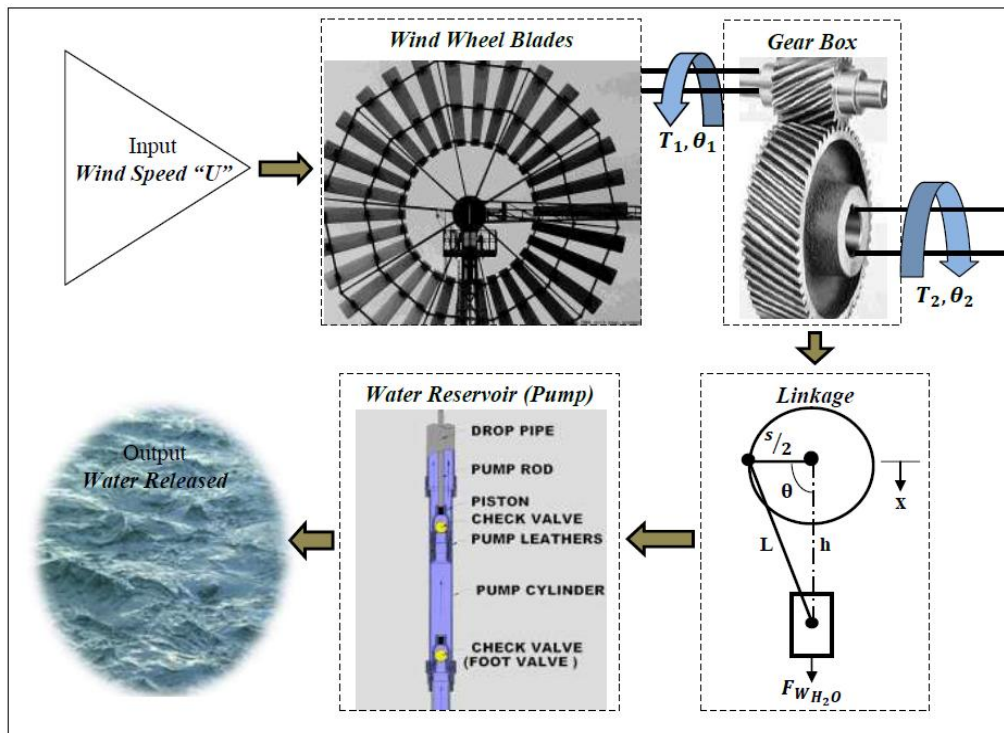

Figure No 3: Concept of project [3]

II. LITERATURE REVIEW

- A. Blade design and performance testing of a small wind turbine rotor for low wind speed applications

Author Name: Ronit K. Singh, M. Rafiuddin Ahmed

Journal Name: Science Direct

Results : Turbine performing best at 18 degree pitch angle. Peak power coefficient attained by the 2-bladed rotor design at 6 m/s wind speed was 0.29.

- B. Optimized Design of Rotor Blade for a Wind Pump

Author Name: Prasad S.S., Virupaxi Auradi

Journal Name: International Journal of Renewable Energy Research

Results : $P = \frac{1}{2} \rho AV^3$, $P_{out} = 0.5 C_p \rho AV^3$ Watts , $P_{in} = 0.5 \eta_t C_p \rho AV^3$ Watts ,

$P = P_{hyd} / \eta_p$, $\lambda_r = \lambda_d r / R$. Increasing the chord width or the number of blades may not necessarily result in higher CP on the other hand; a good combination of the blade parameters with lower chord width and fewernumbers of blades can result in higher CP. In the present case, a blade with 30mm chord at the tip and 500 mm chord at the root with 4

International Journal of Innovative Research in Science, Engineering and Technology

(A High Impact Factor, Monthly Peer Reviewed Journal)

Vol. 5, Issue 1, Januray 2016

blades. and with twist varying from 8 degree at the tip to 32 degree at the root gives a CP of 0.43, which is the best for the rated wind speed and the diameter of the rotor.

C. Renewable energy source water pumping systems—A literature review

Author Name: C. Gopal Mohanraj , Chandramohan , Chandrasekar

Journal Name: Science Direct

Results : For VAWT $A_s = D_t \cdot l_b$, **Solidity** = N_c / R_{rotor} , $\Phi = 2/3 \arctan(1/\lambda_r)$,

$$\sigma = (B \times C) / (2\pi r), \Phi = \alpha + \beta .$$

D. Energy for water pumping in rural areas in sudan

Author Name: Abdeen Mustafa Omer

Journal Name: International Journal of Engineering and Technology

Results : Mean wind speeds of 4 ms⁻¹ are available over 50% of Sudan, which suited for water lifting and intermittent power requirements, while there is one region in the eastern part of Sudan that has a wind speed of 6 ms⁻¹, which is suitable for power production. The data presented in this paper can be considered as a nucleus of information for research and development of wind energy project; however, detailed investigation should determine the best specific sites. Local manufacturer, whenever possible, it is recommended for wind pump systems. Low cost designs as well as reliable devices have to be provided.

power density: $P_a/A = 0.5 \rho V^3$

$$P = 0.3409 V^3 .$$

E. Design of a low Reynolds number airfoil for small horizontal axis wind turbines

Author Name: Ronit K. Singha, M. Rafiuddin Ahmeda, Mohammad Asid Zullahb,

Young-Ho Leeb

Journal Name: Science direct

Results : The airfoil showed good lift characteristics at low Reynolds numbers and at an angle of attack as high as 14. The flat-back trailing edge of the AF300 airfoil has improved aero-dynamic properties by increasing CL and the adding strength to the airfoil structure. structural strength added by the thick trailing edge of the airfoil would require lighter and less expensive materials for the blades ,decreasing the inertia and improving start-up and letting the rotors operate at lower cut-in wind speeds.

III. TYPES OF WIND TURBINES

There are **two** types of **wind turbines**. One is **Vertical axis wind turbines** and the other is **horizontal axis wind turbines**. We also know that there is sufficient wind to satisfy much of humanity's energy requirements – if it could be gathered effectively and on a large scale.

International Journal of Innovative Research in Science, Engineering and Technology

(A High Impact Factor, Monthly Peer Reviewed Journal)

Vol. 5, Issue 1, Januray 2016

- a. Vertical Axis Wind Turbines (VAWT) :- Vertical axis **wind turbines (VAWTs)** which may be powerful, practically simpler and significantly cheaper to build and maintain than horizontal axis **wind turbines (HAWTs)**. They have advantages, such as they are always facing the wind, which might make them a important for cheaper, cleaner renewable resources of electricity. VAWTs might even be critical in problems like currently facing electricity producers and suppliers. Moreover, cheaper VAWT's which may provide an alternative to destruction of the rain forest for the growing of bio-fuel crops.

Vertical axis wind turbines (VAWTs) in addition to being simpler and cheaper to build, it has the following advantages:

- They are always facing the wind hence no need to escort for the wind.
- Have greater surface area for energy storage hence can store more energy.
- Are more efficient in stormy or breezy winds.
- Can be installed in locations like on roofs, along highways, in parking lots.
- Can be scaled more easily from milliwatts to megawatts.
- Can be significantly less expensive to produce as they are inherently simpler .
- Can have low maintenance downtime as mechanisms are at or near ground level.
- Produce less noise due to low speed hence less noise.



Figure No 4 : Vertical axis wind turbine [5]

- b. Horizontal Axis Wind Turbines(HAWT) : Horizontal-axis wind turbines (HAWT) has the rotor main shaft and electrical generator at the top of a tower, and may be pointed into or out of the wind. Small turbines are pointed by a simple wind vane, while large turbines generally use a wind sensor coupled with a servo motor. Most have a gearbox, which turns the slow rotation of the blades into a quicker rotation that is more suitable to drive an electrical generator.

International Journal of Innovative Research in Science, Engineering and Technology

(A High Impact Factor, Monthly Peer Reviewed Journal)

Vol. 5, Issue 1, Januray 2016

Some advantages of HAWT are –

- Variable blade pitch which gives the blades of turbines the optimum attack angle. Allowing the attack angle to be adjusted gives greater control, so that turbine can stores the maximum amount of wind energy for the day and season time .
- High efficiency, since the turbine blades always move perpendicularly to the wind, collecting power through the whole rotation. All **vertical axis wind turbines**, and most airborne wind turbine designs, include various types of reciprocating actions, requiring surfaces of the airfoil to backtrack against the wind for part of the cycle. Backtracking against the wind give rise to inherently lower efficiency.
- The taller tower base provides access to stronger wind in sites with **wind shear**. In some wind shear sites, every ten meters up, the speed of the winds can increase by 20% and the output power by 34%.



Figure No 5: Horizontal axis wind turbine [5]

A. Characteristics & Specifications Of Wind turbines:-

a) Wind Speed:-

This is very important to the productivity of a windmill. The wind turbine only produces power with the wind. The wind rotates the horizontal or vertical axis and causes the generator shaft to sweep past the magnetic an electric current.

b) Blade Length:-

This is important as the blade length is proportional to the swept area. Larger blades have a greater swept area and thus catch more wind. Because of this, they may also have more torque.

International Journal of Innovative Research in Science, Engineering and Technology

(A High Impact Factor, Monthly Peer Reviewed Journal)

Vol. 5, Issue 1, Januray 2016

c) Base Height:-

The height of the base affects the windmill immensely. If the windmill is higher, it will become more productive as the altitude increases due to which increase in winds speed.

d) Base Design:-

Some base design may be more stronger than others. Base is most important during the construction of the windmill because not only they support the windmill, but also they are subjected to their own weight and the drag of the wind. If a tower having weak base is subjected to these elements, then it will definitely collapse. Therefore, the base must be identical to ensure a fair comparison.

B. Requirements For Placing:-

a. Site Selection considerations:-

The power available in the wind increases rapidly with the speed; hence wind energy conversion machines should be placed in areas where the winds are strong & endless. The following point have to be understand while selecting site for Wind Energy Conversion System (WECS).

b. High annual average wind speed:-

The wind velocity is the most important parameter. The power in the wind P_w , through a given X – section area for a uniform Velocity of wind is given as :

$$P_w = KV^3 \text{ (K is constant)}$$

It is important, because of the cubic dependence on velocity of wind. small increases in V affect the power in the wind

E.g. doubling V, increases P_w by a factor of 8.

c. Availability of wind V_w curve at the proposed site:-

This availability of wind curve help us to determine the maximum energy in the wind and hence it is desirable to have average speed of wind V such that

$$V \geq 12-16\text{km/hr i.e. (3.5 – 4.5 m/sec).}$$

d. Wind structures at the proposed site:-

Wind notably near the ground is turbulent and gusty, & changes rapidly in direction and in velocity. This separation from homogeneous flow is called as “the structure of the wind”.

e. Altitude of the proposed site:-

It affects the air density and thus the power in the wind & hence a useful WECS electric power o/p. The wind tends to have higher velocities at higher altitudes.

f. Local Ecology:-

If the surface is naked rock it may mean lower hub heights hence lower cost of structure, if trees or grass or venations are present. All of these tends to destructure the wind.

g. Nearness of site to local center/users:-

International Journal of Innovative Research in Science, Engineering and Technology

(A High Impact Factor, Monthly Peer Reviewed Journal)

Vol. 5, Issue 1, Januray 2016

This criterion decreases length of transmission line, hence losses & costs.

h. Nature of ground:-

Ground condition should be such that the foundations for WECs are secured, surface of ground should be stable.

IV. DESIGN PROCEDURE

Steps in designing rotor of small wind turbines are as follows:

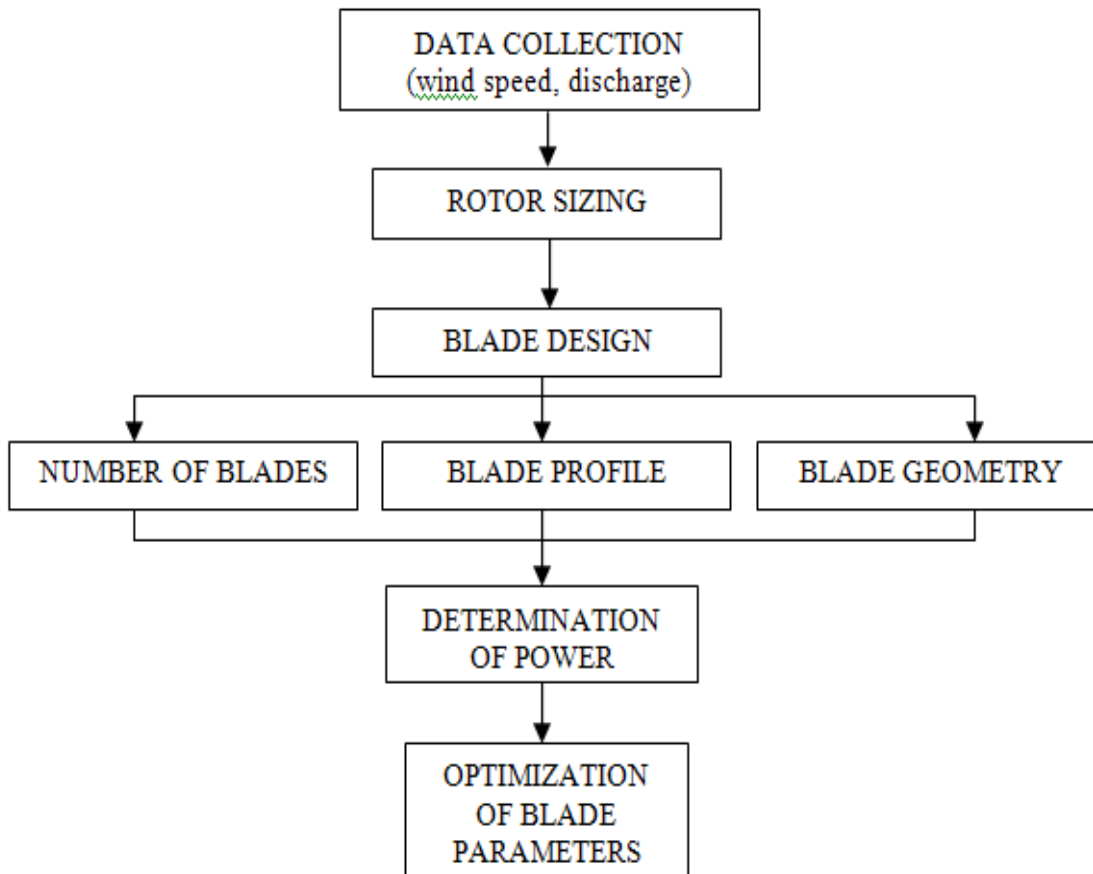

Figure No 6 : Design procedure of small wind turbines [8]

A. Sizing of Rotor

The power of the wind is proportional to air density, area of the segment of wind being considered, the natural wind speed. The relationships between all the above variables are given in equation [1]

$$P_w = \frac{1}{2} \rho A u^3 \dots \dots \dots [1]$$

Where,

P_w: power of the wind (W)

M: air density (kg/m³)

International Journal of Innovative Research in Science, Engineering and Technology

(A High Impact Factor, Monthly Peer Reviewed Journal)

Vol. 5, Issue 1, Januray 2016

A: area of a segment of the wind being considered (m²)

u: undisturbed wind speed (m/s)

At standard pressure and temperature (STP = 273K and 101.3 KPa), equation [1] reduces to:

$$P_w = 0.647 \rho A u^3 \dots\dots\dots [2]$$

A turbine cannot extract or take 100% of the winds energy because some of the winds energy used in pressure changes occurring across the blades of turbines. This pressure change causes velocity to decrease and therefore usable energy.

- The mechanical power which could be obtained from the wind with an ideal turbine is given as:

$$P_m = \frac{1}{2} M (16/27 A u^3) \dots\dots\dots [3]$$

Where,

P_m: mechanical power (W)

A: swept area of a turbine

16/27 : Betz coefficient

The Betz coefficient give idea that 59.3% of the power in the wind can be obtained in the case of an ideal turbine.

- For a VAWT, This area depends on both the diameter and blade length of turbine .

$$\text{swept area is: } A_s = D_t l_b \dots\dots\dots [4]$$

Where,

A_s: swept area (m²)

D_t: diameter of the turbine (m)

l_b: length of the turbine Blades (m)

- Efficiency of turbines lies in the range of 35-40% is very good, and occurs only in case for large-scale turbines. It is important to note that the pressure drop across the turbine blades is very small, around 0.02% of the ambient air pressure.

so , Equation [3] can be re-written as $P_m = C_p P_w \dots\dots\dots [5]$

The coefficient of performance depends on speed of wind, rotational speed of the turbine and blade parameters such as pitch angle and angle of attack.

I. Aerodynamic Design of Blade: Calculation of Blade Setting Angle

- Let us consider that the blade is divided into 8 equal segments or elements. Now, consider in a unit element the local tip speed ratio is given by: $\lambda_r = \lambda_d r / R$

where,

r = radius of each element from the center of the rotor.

c = chords at radius r.

Φ = local angle between relative wind direction and rotor plane.

R = radius of the rotor

And local angle between relative direction of wind and plane of rotor is given as :

International Journal of Innovative Research in Science, Engineering and Technology

(A High Impact Factor, Monthly Peer Reviewed Journal)

Vol. 5, Issue 1, Januray 2016

$$\Phi = 2/3 \text{ arc tan } (1/\lambda_r)$$

The local solidity, σ is given by $\sigma = (B \times C)/(2\pi r)$

where,

B = number of blades

C = Chords at radius r

- We also know that $\Phi = \alpha + \beta$

where,

β = blade setting angle

α = angle of attack

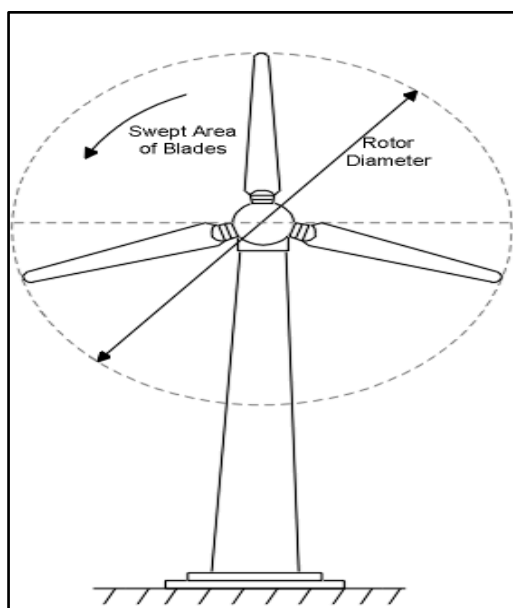

Figure No 7: Aerodynamic design of blade [2]

II. Optimization Of Blade Parameters & Linearization Of Blade Setting Angle

- For a given rotor diameter, most optimized values for blade parameters is obtained for maximum power coefficient. The blade parameters that has to be optimized are chord, quantity of blades and setting angles of blades . A computer program like Turbo C is used for finding out the C_p for different blade parameters.
 - The values of β varies from root to blade tip and is not linear. Fabrication such a blade with varying twist at each element is difficult and expensive. Hence, as per standard codes we have to keep the value of α between 2 - 8°.

International Journal of Innovative Research in Science, Engineering and Technology

(A High Impact Factor, Monthly Peer Reviewed Journal)

Vol. 5, Issue 1, Januray 2016

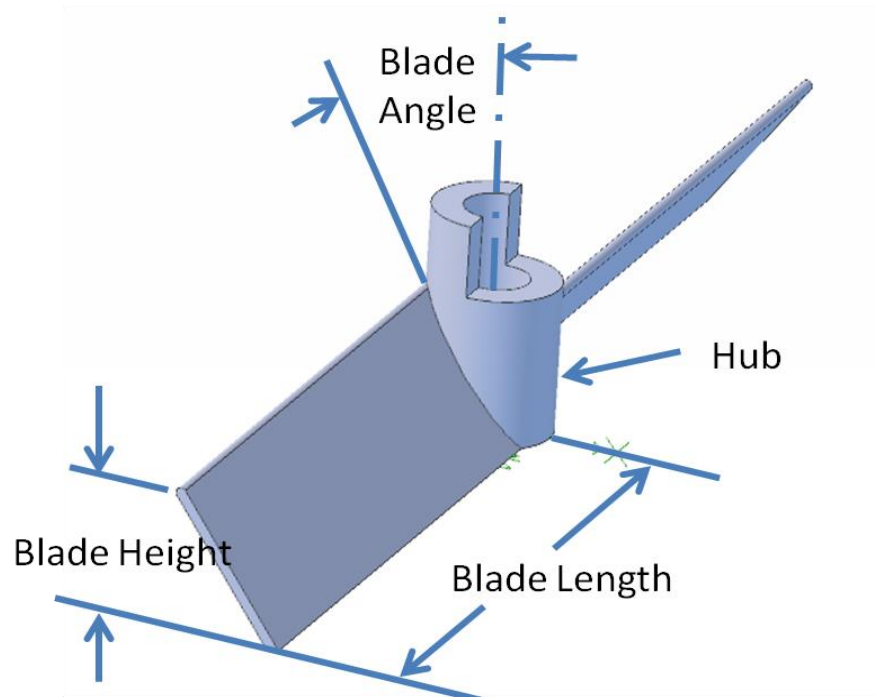

Figure No 8: Optimization of blade parameters [6]

III. Airfoil & Its Behaviour

- An airfoil-shaped body displaced through a fluid generates an aerodynamic force. The first component of this force in direction perpendicular to motion is called lift. The second component of this force in direction parallel to the motion is called drag.
- Subsonic flight shaped airfoils have a shape with a rounded leading edge, followed by a sharp trailing edge, often with asymmetric camber. The lift on an airfoil blades is primarily due to the result of its angle of attack and shape.
- When blades are oriented at a suitable angle, the airfoil shaped blades deflects the on-coming air, resulting in a force on the airfoil in the direction opposite to the deflection. This resultant force is known as aerodynamic force and can be resolved into two components: Lift and drag.
- Most airfoil shapes blades require a positive angle of attack to produces lift, but cambered airfoils can generate lift at zero attack angle .

International Journal of Innovative Research in Science, Engineering and Technology

(A High Impact Factor, Monthly Peer Reviewed Journal)

Vol. 5, Issue 1, Januray 2016

Lift and drag forces experienced by turbines blades is shown in figure below:

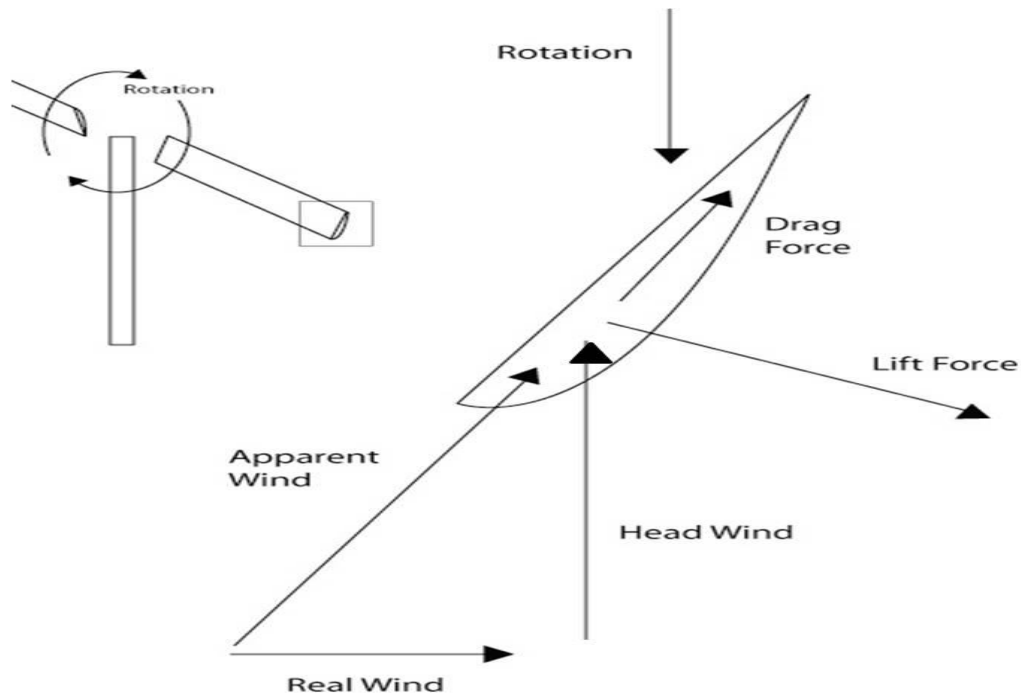

Figure No 9: Subsonic flight type airfoils [6]

IV. Airofoil Behaviour

- Before studying the airfoil-behaviour, Mach number and Reynolds number need to be studied. Mach number is nothing but a ratio of speed of an object over sound and it is defined as: $M_a = v_s / u_c$
- Where M_a is Mach Number, v_s is object speed, u_c is sound speed. Subsonic is explained as $Mach \leq 1$, transonic is characterized as $Mach = 1$, supersonic is designated as $Mach \geq 1$, and hypersonic is defined as $Mach \geq 5$.

International Journal of Innovative Research in Science, Engineering and Technology

(A High Impact Factor, Monthly Peer Reviewed Journal)

Vol. 5, Issue 1, Januray 2016

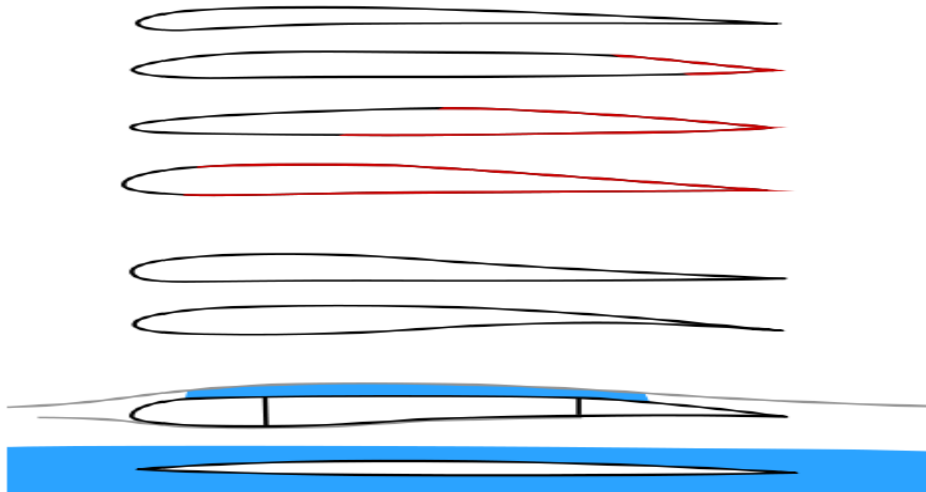

Figure No 10: Different flow in airfoil [15]

- Black = laminar flow, red = turbulent flow, grey = subsonic stream, blue = supersonic flow volume.
- The Reynolds number is a non-dimensional value and it is a ratio of inertial force to viscous force, designated as: $Re = \rho VL / \mu$
- Airfoil behaviour can be described into three flow regimes: **the attached flow regime, the high lift/stall development regime and the flat plate/fully stalled regime.**
- In attached flow regime, flow is considered at the upper surface of airfoil, in this situation, lift increases with the angle of attack.
- In high lift/stall development regime, the lift coefficient peaks as the airfoil becomes increasingly stalled.
- Stall occurs when the angle of attack exceeds a certain value (depending on the Reynolds number) and separation of the boundary layer on the upper surface takes place.
- It is essential to study the airfoil behaviour: aerodynamic performances are different because of different geometry of airfoil, and according to different airfoil's behaviour, choosing an applicable airfoil for wind turbine blade will improve the efficiency.
- The design of the turbines rotors is perhaps the most important step of the entire turbine design. The rotors use aerodynamic lift to provide a turning moment and consequently an input torque to the gearbox.
- There are many different standardized airfoil profiles varying in cross-sectional profile and can be most recognizably characterized by their camber, thickness and chord length.
- The design of the blades used in this project will be based upon blade element theory and the Betz equation

International Journal of Innovative Research in Science, Engineering and Technology

(A High Impact Factor, Monthly Peer Reviewed Journal)

Vol. 5, Issue 1, Januray 2016

V. MATERIAL CONSIDERATION FOR WINDMILL

The efficiency of a wind mill changes thus for good output it is important to check material and its property for different material the property are shows in fig(Table).

Property	Aluminum Extrusions	Molded Plastic	Wood	Vinyl (Polyvinyl Chloride)
Strength (Tensile)	Very good mechanical properties.	Wide variation in properties from 0.08 to 8 tensile strength of aluminum extrusions for glass filled compounds.	Good compressive properties, variable with the species of wood and moisture content.	Low mechanical properties.
Density	Lightweight about 1/3 that of copper or steel.	Very lightweight about 60% the weight of aluminum.	Very lightweight about 1/3 the density of aluminum.	Very lightweight about 60% the density of aluminum.
Strength	Very Good.	good.	good.	good.

Formability	Easily formable and extruded in a wide variety of complex shapes including multi-void hollows.	Easily formed or molded into complex shapes.	Poor; cannot be routinely formed.	Easily formed or molded into complex shapes.
-------------	--	--	-----------------------------------	--

International Journal of Innovative Research in Science, Engineering and Technology

(A High Impact Factor, Monthly Peer Reviewed Journal)

Vol. 5, Issue 1, Januray 2016

Electrical Conductivity	Excellent; twice as efficient as copper, used in bus bar and electric connector applications.	Poor; used as an insulator, high dielectric capability.	Poor; cannot be used as an electrical conductor Usually cannot be employed as an insulator.	Poor; electrical and thermal insulating characteristics.
Thermal Conductivity	Excellent; ideal for heat exchanger applications.	Poor; low coefficient of thermal (heat) transfer.	Poor.	Poor.
Finishing	A finishes can be applied including mechanical and chemical prefinishes, anodic coatings, paints and electroplated finishes.	Color can be integral with material as well as plated, painted, and hot stamped.	Paint and stain coatings can be employed.	Color can be integral with material.

International Journal of Innovative Research in Science, Engineering and Technology

(A High Impact Factor, Monthly Peer Reviewed Journal)

Vol. 5, Issue 1, Januray 2016

Product Specification:-

Height Without Handle	10" (10 Inches)
Height With Handle	14" (14 Inches)
Weight	4 Kgs. Approx.
Material Used	Cast Iron
Cup Seal (Bracket Washer Size)	3" (3 Inches)
Suction Capacity	2 to 2.5 Feet's
Pipe Fitting Size	21.75 mm
Colour/Paint	Dark Green or Blue Standard Paints
Packing	Corrugated Box Packing
Maximum Discharge Water	

VIII. WINDMILL CALCULATIONS

- For home application, to lift the water up to 250 feet, 1hp power motor is normally used which can serve purpose of 1 home.
- So considering 1hp power, we first find how much area will be required during design of blades.
- Power, $P = 0.5 \rho A v^3$
 $746W = 0.5 \times A \times 1.2940 \times 5^3$
 $A = 9.224m^2$
- From power equation , power available is proportional to air density (1.225 kg/m^3) & is proportional to the intercept area. Since the area is normally circular of diameter D in vertical axis aero turbines then,
- Swept area $A = \pi D^2 / 4 \text{ m}^2$
 $9.224m^2 = 3.14 * D^2 / 4$
 $D = 3.4278 \text{ m}$
- and also swept area equation is $A_s = D_t l_b$
 $9.224 = 3.4278 * l_b$
 $l_b = 2.690 \text{ m}$
- Consider standard temperature and pressure (0°C and 101.3KPa) $\rho = 1.2940 \text{ kg/m}^3$
- **$P_{out} = 0.5 \times C_p \times \rho \times A \times v^3 = 0.5 \times 0.3 \times 1.2940 \times 9.446 \times 5^3 = 223.8 \text{ W}$**
- Assuming Transmission Efficiency= 95%

International Journal of Innovative Research in Science, Engineering and Technology

(A High Impact Factor, Monthly Peer Reviewed Journal)

Vol. 5, Issue 1, Januray 2016

$$P_{in} = P_{out} \times \eta_t = 0.95 \times 223.8 = 212.61 \text{ W}$$

$$P_{hyd} = \rho g H Q = 9.81 \times 0.6096 \times 9.224 \times 5 = 275.805 \text{ W}$$

- Power required to run the pump i.e. $P = P_{hyd} / \eta_p = 275.805 / 0.70 = 394.007 \text{ W}$

Hence, only 394.007 W (0.528 HP) power is required for pumping water under head of 2-2.5 feet and discharge of 46.12 m³/s . Means it is clear that almost half power is require to lift water for given head and discharge .

IX. STEPS IN DESIGNING

- A) First a base chaise has been built by using angles and channels it has been properly welded so as to bear the weight of wind mill.
- B) Then a vertical shaft was fitted on it.
- C) Two disks were fitted at the ends of shaft and aluminium blades were cut and fitted at circular curvature of two disks.
- D) A water pump and valve assembly was installed at other end.



Figure No 18: Project setup

X. PROJECT DESCRIPTION

Pumping water was one of the first and most important uses for windmills. Using the energy for turning a millstone to grind grain is also important. These days, windmills are used mostly for the generation of electricity but you may still find some old ones grinding grain or pumping water. A water pump operates on reciprocating motion -- up and down pushing and pulling on a piston which draws water up out of the well. In addition, there is a one-way valve to keep the water from flowing back into the well when the pump makes.

A windmill generates rotary motion by turning a shaft. The speed of the turning can be adjusted by using gears of different sizes. To turn the rotary motion of a shaft into reciprocating motion, a slider crank mechanism is used. A link is attached perpendicular to the rotating shaft, and another rod is attached vertically from the edge of the wheel to the pump down below. Because the center of the wheel does not move but the edge goes round and round, the rod will be pulled up and these days, you can generate electricity with a windmill and connect that to an electric water pump. There are always losses of energy in each conversion step.

International Journal of Innovative Research in Science, Engineering and Technology

(A High Impact Factor, Monthly Peer Reviewed Journal)

Vol. 5, Issue 1, Januray 2016

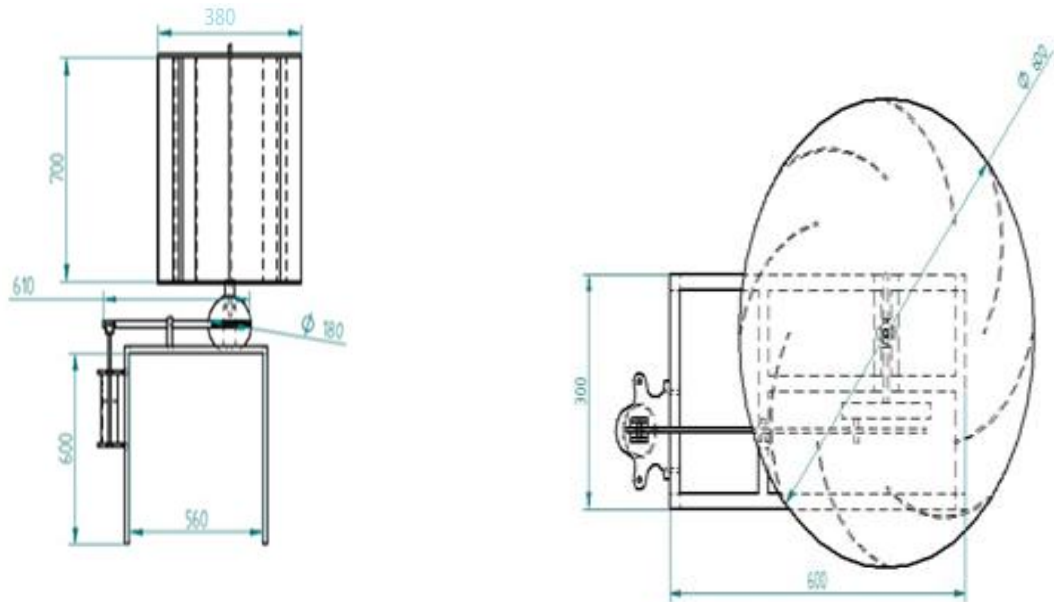

FRONT VIEW

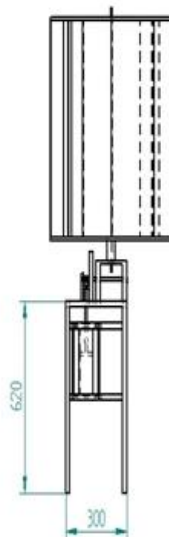

SIDE VIEW

Figure No 19 : Cross sectional view of windmill

XII. OPERATION

A. How Blades Work:-

- The wind imposes two driving forces on the blades of a turbine; lift and drag.

International Journal of Innovative Research in Science, Engineering and Technology

(A High Impact Factor, Monthly Peer Reviewed Journal)

Vol. 5, Issue 1, Januray 2016

- A force is produced when the wind on the leeward side of the airfoil must travel a greater distance than that on the windward side.
- The wind travelling on the windward side must travel at a greater speed than the wind travelling along the leeward side.
- This difference in velocity creates a pressure differential. On the leeward side, a low-pressure area is created, pulling the airfoil in that direction.
- This is known as the Bernoulli's Principle.
- Lift and drag are the components of this force vector perpendicular to and parallel to the apparent or relative wind, respectively. By increasing the angle of attack.

B. How Wind-Mill Work:-

A water pump operates on reciprocating motion -- up and down pushing and pulling on a piston which draws water up out of the well. In addition, there is a one-way valve to keep the water flowing back into the well.

A windmill generates rotary motion by turning a shaft. The speed of the turning can be adjusted by using gears of different sizes. To turn the rotary motion of a shaft into reciprocating motion, a slider crank mechanism is used. A link is attached perpendicular to the rotating shaft, and another rod is attached vertically from the edge of the wheel to the pump down below. Because the center of the wheel does not move but the edge goes round and round, the rod will be pulled up and down (and a little bit to the side and back each time, so you'll need a hinge joint when connecting the rod to the water pump's piston).

XIII. COST ESTIMATION

Item	Quantity	Use	Cost (Rs.)
Mild Steel	-	In manufacturing of support frame& in parts of slider crank mechanism.	850 Rs
Mild Steel	2	In manufacturing of main shaft & turbine shaft.	700 Rs
Poly Vinyl Chloride Pipe	2	In manufacturing of turbine blades.	650 Rs
Plastic Bevel Gears	2	In transmission of power	1250 Rs

International Journal of Innovative Research in Science, Engineering and Technology

(A High Impact Factor, Monthly Peer Reviewed Journal)

Vol. 5, Issue 1, Januray 2016

Bearing & bearing block	6	To support the shaft	1200 Rs
Machining Operation 1.Welding 2.Grinding 3.Cutting	-	To weld the parts To cut the parts For finishing purpose	1400 Rs
single acting piston pump	1	Pump the water	3300 Rs
minor items, such as setscrews, bolts, nuts, and washer	As per required	Joining	650 Rs
TOTAL COST	-	-	10,000 Rs

REFERENCES

- [1] U.S. Department of Energy. "Wind and Hydropower Technologies Program" Retrieved from http://eereweb.ee.doe.gov/windandhydro/wind_how.html in November, 2005.
- [2] http://practicalaction.org/docs/technical_information_service/windpumps
- [3] T H Taylor, Alternate Energy Sources, Adam Hilger Ltd, Bristol, 2001
- [4] Wind Power Workshop: Building Your Own Wind Turbine by Hugh Piggott Centre for Alternative Technology Publications, 2011
- [5] F. Manwell, Jon G. McGowan & Anthony L., Wind Energy Explained: Theory, Design and Application, James Rogers Pub, John Wiley and sons Ltd., 2002
- [6] E. Hau, Wind Turbines: Fundamentals, Technologies, Applications, Economics, Springer Verlag, 29-Feb-2012
- [7] Kirke, Brian Kinloch, 1998. "Evaluation of Self-Starting Vertical Axis Wind Turbines for Stand-Alone Applications". Griffith University, Australia. Retrieved (taken) from <http://www4.gu.edu.au:8080/adt-root/public/adt-QGU20050916.120408/> on November 1, 2005.
- [8] Pawsey, N.C.K., 2002. "Development and Evaluation of Passive Variable-Pitch Vertical Axis Wind Turbines", School of Mechanical and Manufacturing Engineering.
- [9] Giguere P, Selig MS. New airfoils for small horizontal axis wind turbines ASME Journal of Wind Energy Engineering 1998;120:108e14.
- [10] Elizondo J, Martinez J, Probst O. Experimental study of a small wind turbine for low- and medium-wind regimes. International Journal of Energy Research 2009;33:309e26.
- [11] U.S. Department of Energy. "Wind and Hydropower Technologies Program". Retrieved from http://eereweb.ee.doe.gov/windandhydro/wind_how.html
- [12] Wikipedia Encyclopedia. Retrieved from <http://en.wikipedia.org/wiki/Image:HDarrieus-Rotor.png.jpg> on November 28, 2005.
- [13] Chang, Professor L. (2005) "Advanced Topics in Environmental Engineering -
- [14] Wind Power," Ch. 4. University of New Brunswick. Retrieved from <http://www.ece.unb.ca/powereng/courses/EE6693/index.html>
- [15] <http://www.av8n.com/how/htm/airfoils.html> in November 2005.
- [16] Sheldahl, Robert E., Klimas, Paul C., 1981. "Aerodynamic Characteristics of Seven Symmetrical Airfoil Sections Through 180-Degree Angle of Attack for Use in Aerodynamic Analysis of Vertical Axis Wind Turbines", Sandia National Laboratories, Albuquerque, NM., USA.
- [17] Wind Power Workshop: Building Your Own Wind Turbine by Hugh Piggott Centre for Alternative Technology Publications, 2011
- [18] Paul Gipe Chelsea, Wind energy basics: A guide to small and micro wind systems, Green Pub. Co., 1999.
- [19] F. Manwell, Jon G. McGowan & Anthony L., Wind Energy Explained: Theory, Design and Application, James Rogers Pub, John Wiley and sons Ltd., 2002
- [20] Paul Gipe, Wind Power: Renewable Energy for Home, Farm, and Business, Chelsea Green Pub. Co., 2005

International Journal of Innovative Research in Science, Engineering and Technology

(A High Impact Factor, Monthly Peer Reviewed Journal)

Vol. 5, Issue 1, Januray 2016

BIOGRAPHY



Ronak Dipakkumar Gandhi is a BE Mechanical student in the MIT Academy of Engineering , Pune University , Pune , Maharashtra , India



Debarshi Sharma is a BE Mechanical student in the MIT Academy of Engineering , Pune University , Pune , Maharashtra , India



Bhushan Kumbhare is a BE Mechanical student in the MIT Academy of Engineering , Pune University , Pune , Maharashtra , India



Shubham Choukade is a BE Mechanical student in the MIT Academy of Engineering , Pune University , Pune , Maharashtra , India