

# Behaviour of Short Pile in Reinforced Slope Subjected to Inclined Load

Dr. A. I. Dhatrak<sup>1</sup>, Gaurav Bhagat<sup>2</sup>

Associate Professor, Department of Civil Engg., Government College of Engineering, Amravati, Maharashtra, India<sup>1</sup>

P.G. Student, Department of Civil Engg., Government College of Engineering, Amravati, Maharashtra, India<sup>2</sup>

**ABSTRACT:** An extensive program of laboratory tests was carried out to study the effect of reinforcing an earth slope on the lateral behavior of a single vertical pile located near the slope. Layers of geogrid were used to reinforce a sandy slope of 1V:2H. Several tests were conducted to study the effect of number of geogrid reinforcement. The experimental program also included studies of the location of pile relative to the slope crest and angle of load inclination. The results indicate that stabilizing a soil slope has a significant benefit of improving the ultimate lateral load of a vertical pile. The improvement in pile ultimate lateral load was found to be strongly dependent on the number of geogrid layers, location of pile relative to slope crest and angle of load inclination.

**KEYWORDS:** Lateral loading capacity, Lateral deflection, Pile, Slope

## I. INTRODUCTION

The civil engineering developments are continuing all over the world. Infinite land on the earth has becoming finite for the construction. Structures like, bridge abutment on steep river slope, open type berthing structure, electric / telephone poles on high way/ railway embankment and approach to water intake tower in river /sea are constructed in sloping ground and this structures are subjected to lateral load due to the lateral soil movement of unstable slope. Lateral movement of these unstable slope results in large lateral force on pile supported structures. Due to such lateral loads and the no availability of good construction sites, engineers are often required to place footings at crest or near slopes. The general scenario is to design the footings on a crest of a slope. The effect of lateral forces and lateral soil movement is not considered while designing the footings placed away from the crest. The effect of the various parameters which will have the effect on the lateral resistance capacity and lateral movement are studied under the behaviour of single pile in slope subjected to inclined load.

Various methods to stabilize slopes include soil nailing, reinforcing with layers of geogrid, and installation of piles or vertical sheet piles. The conclusion drawn from the literature is that stabilizing earth slope has a significant effect on the overall stability of the slope and on improving the bearing capacity of a shallow foundation supported on/near a reinforced ground slope. There exists a lack of knowledge concerning pile behavior and the effects of these reinforcements on the pile lateral bearing load. Therefore, the aim of this research was to define more clearly the response of pile located near sandy slopes reinforced with layers of geogrid.

The main objectives was to conduct experimental investigation of laterally loaded piles on reinforced slope. Also, to investigate and establish the relationship between the pile response and number of geogrid layers and to determine optimum number geogrid reinforcements and the effect of inclined loading.

Initially, in this paper, the results of model tests of single pile subjected to lateral loading and inclined loading in homogeneous sand with 1V;2H reinforced slope are compared. Angle of inclined loading is varied as 0°, 15° and 30°. Series of single short pile tests were conducted to investigate the effect of horizontal distance from the pile to the crest of the slope. In short pile, focus was placed on the ultimate lateral load of single pile. The model pile had a constant embedment depth/diameter ( $D_e/B$ ) ratio of 10.0 in all tests.

# International Journal of Innovative Research in Science, Engineering and Technology

(An ISO 3297: 2007 Certified Organization)

Vol. 5, Issue 6, June 2016

## II. RELATED WORK

This literature review presents research conducted on lateral load testing programme and the effects of slope on lateral capacity on piles in cohesionless soils. An overview of the different methods and theories used in the analysis of the lateral capacity of piles in level (horizontal) ground and on the slopes are presented.

The work done by various authors is summarized as follows:

1. Reese *et al.* (1974)<sup>1</sup> conducted full scale tests on 24 inch diameter piles in clean fine to silty sands with a friction angle,  $\phi=39^\circ$ . The water table was above the ground surface during these tests. Static and cyclic lateral load tests were carried out on the test piles. A set of p-y curves and equations were developed based on the experimental results. According to Reese, two different wedge types can be distinguished, one for clay and one for sand.
2. Mirzoyan (2007)<sup>2</sup> carried out a near slope full-scale lateral load test in a cohesionless soil. The testing consisted of three lateral load tests on 12in diameter steel pipe piles located on the crest (0d) slope and three pile diameters (3d) behind the crest. A baseline tests was also conducted to in horizontal ground for comparison of results. Each pile was laterally loaded in partially saturated dense sand with a relative compaction of 95% and a friction angle of  $39^\circ$ . The 0d and 3d piles tests near a  $30^\circ$  slope.
3. Nimityongskul (2010)<sup>3</sup> conducted a series of full scale tests at the test site of the oregon state university for his dissertation [3]. This included two tests in horizontal ground, four tests at a distance 8d, 4d, 2d and 0d from the crest of the slope, and one test in the slope at a distance -4d from the crest. The first soil layer, which was 10d thick, consisted of cohesive soil, in which a slope was excavated of 2:1 to a depth of 2.75m. This layer was underlain by alternating layers of sand and clay. The embedded length of the tested piles was 7.9m.
4. Mostafa El Sawwaf<sup>4</sup> (2006) carried out to study the effect of reinforcing an earth slope on the lateral behavior of a single vertical pile located near the slope. Layers of geogrid were used to reinforce a sandy slope of 1(v):1.5(h) made with sands of three different unit weights representing dense, medium dense, and loose relative densities. Several configurations of geogrid reinforcement were investigated. The experimental program also included studies of the location of pile relative to the slope crest, relative density of sand, and embedment length of pile.
5. Chae *et al.*<sup>13</sup> (2004) conducted several studies investigating the lateral resistance of piles located near slopes. Three dimensional finite-element analyses along with scaled-model tests were conducted on laterally loaded short piles or pier foundations situated in proximity to slopes consisting of dense sand. The scaled-model test was conducted for short piles near a  $30^\circ$  test slope and in horizontal ground conditions for use as a reference. A clean sand with a relative density  $d_r$  of 90% and a corresponding friction angle of  $47.5^\circ$  were used in this experiment. The scaled-model lateral testing was conducted at 0d, 2d, and 4d where d is the pile diameters from the crest. This paper describes the results of several numerical studies performed with a three-dimensional fem model tests and a prototype test of a laterally loaded short pile and pier foundation located near slopes, respectively.

## III. MATERIALS & PROPERTIES

The materials used for the project was Kanan sand and long pile is made up of mild steel.

### 3.1 Test Sand:

For the model tests, cohesionless, dry, clean and wash Kanan sand was used as the foundation material.

### 3.2 Model Pile

The pile was 100mm in length and the length to diameter ratio of pile was 10. There are several factors that affect the lateral resistance of a pile but the dominant one is the pile stiffness, which determines whether the pile behaves rigidly or as flexible pile. Laterally loaded pile behaves as a rigid pile based on the value of the stiffness factor  $T$ . In cohesionless soils, this factor is calculated as

# International Journal of Innovative Research in Science, Engineering and Technology

(An ISO 3297: 2007 Certified Organization)

Vol. 5, Issue 6, June 2016

$$T = \sqrt[5]{\frac{E_p I_p}{n_h}}$$

where,  $E_p$  = Modulus of elasticity of the pile material ( $21.4 \times 10^7$  kN/m<sup>2</sup>);  
 $I_p$  = Moment of inertia of the pile cross section ( $4.91 \times 10^{-10}$  m<sup>4</sup>); and  
 $n_h$  = Constant of subgrade reaction at pile tip.

Broms suggested that the embedment depth of the pile has to be less than  $2T$  to be considered as a short rigid pile. Possible values suggested for  $n_h$  are 13500 kN/m<sup>3</sup> for medium-dense sand. The estimated values of  $2T$  for different relative densities are 0.189. Some of the experimental tests were carried out using a pile embedment length of 0.1 m, which is less than the value of  $2T$ , indicating that the test pile satisfy the criterion for a short rigid pile.

### 3.3 Experimental Set Up

The test tank size of 0.7m x 0.4m x 0.5m deep was chosen to avoid any tank-wall effect on the lateral capacity of the piles. The lateral load was applied through a pulley arrangement. The pulley arrangements was fabricated such that the lateral loads could be applied in forward (toward sloping ground). The tests were conducted sloping ground, (1v:2h) with same ( $D_r$ ) relative density. A single pile was tested on each model configuration at the crest of the slope,  $b=2.5D$ ,  $5D$ ,  $7.5D$  in the embankment, away from the slope. Angle of inclined loading is varied as  $0^\circ$ ,  $15^\circ$  and  $30^\circ$ . For all tests, the pile head was maintained as a free-headed condition.

### 3.4 Laboratory Tests

The various laboratory tests were performed to decide the different geotechnical and engineering properties of sand. The properties of sand used are as shown in Table 1.

Table1: Properties of Sand Used

Sr. No.	Properties	Values
1	Type of soil	Sandy soil
2	Specific gravity	2.57
2	$\gamma_{max}$	17.67 kN/m <sup>3</sup>
3	$\gamma_{min}$	16.94 kN/m <sup>3</sup>
4	Angle of internal friction, $\phi$	27.5°
5	Average grain size (D60)	1.10
6	Effective grain size (D10)	0.45
7	Coefficient of uniformity (Cu)	2.44
8	Coefficient of curvature (Cc)	1.03
9	I. S. Classification	Medium sand, SP grade

### 3.5 Laboratory Lateral Load Test

For the experimental investigations, the lateral load tests was conducted on sand and to evaluate the lateral load carrying capacity and lateral deflection. In the laboratory it was maintained by refilling the tank after each test by sand raining technique by funnel method to same density.

### 3.6 Laboratory Set-Up

Laboratory set-up consisted of a tank, a horizontal and inclined loading frame, a model footing, pulleys and dial gauges. Laboratory setup of test tank is shown in Fig.1

# International Journal of Innovative Research in Science, Engineering and Technology

(An ISO 3297: 2007 Certified Organization)

Vol. 5, Issue 6, June 2016



Figure 1: Laboratory Setup of Test Tank

### 3.7 Test Tank

The test tank was made of 4 mm thick having internal dimensions 700mm  $\times$  400mm in plan and 500 mm high. The minimum tank size required to be 5 times the width or breadth of footing whichever was more. The bulging effect was counteracted by providing sufficient thick tank. 3-D view of laboratory test tank is shown in Fig.2

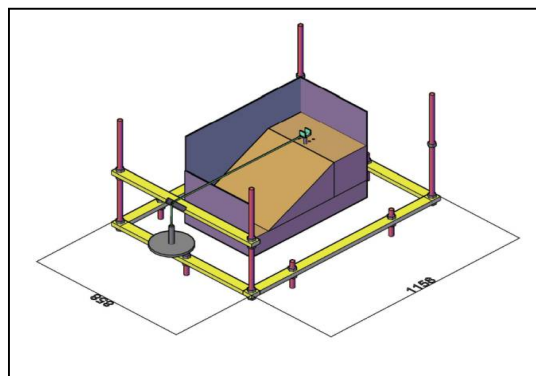

Figure 2: 3D View of Test Tank

### 3.8 Test Programme

An experimental program was carried out to evaluate the effects of lateral behaviour of a pile located near to the slope crest. Soil samples were constructed in layers by controlled pouring and tamping technique with the bed level and slope observed through the front glass wall. 400 mm in height model slopes was constructed with a minimum depth of sand below the base of the model pile of 100 mm  $>$ (5D) to minimize the influence of tank base. The inner faces of the tank was marked at 50 mm intervals to facilitate accurate preparation of the sand bed in layers. On reaching the level of pile base, the pile will be placed on position and is held vertical using special clamp and a layer of sand is poured and tamped. Great care was given to level the slope face using special rulers so that the relative density of the top surface was not affected. Finally, the lateral load was applied incrementally until reaching failure. Each load increment was maintained constant until the pile lateral deflection had stabilized.

All tests were conducted with an artificially made slope of 1V:2H. The pile displacements was measured using two 50 mm travel dial gauges accurate to 0.01 mm placed at two different positions along the length of the pile above the soil surface. Pile rotations at the point of load application was calculated as the ratio of the difference of the two dial gauge readings to the vertical distance between the two measurement points. The details of parametric study are given in Table 2

# International Journal of Innovative Research in Science, Engineering and Technology

(An ISO 3297: 2007 Certified Organization)

Vol. 5, Issue 6, June 2016

Table 2: Details of Parametric Study

Sr. No.	Parameters	Details of parameter
1	No. Of piles	1
2	Location of pile	2.5D, 5D & 7.5D
3	Dia. Of pile	10mm
4	Length of pile	20D
5	Loading condition	Inclined
6	Slope	1v : 2h
7	Roughness of pile	Rough
8	Inclination angle	0°,15° & 30°

## IV. RESULTS AND DISCUSSION

### 1. Load Deflection Behavior of Short Pile with Lateral Load at Distance (b=2.5D)

The test was conducted on short pile of length 10 cm on prepared unreinforced slope and reinforced slope. The load deflection curves for pile with different number of geogrid layers (N) viz., 1,2,3,4 resp. The angle of loading direction is kept to be 0° and pile is located at a 2.5D away from the slope, are shown in Fig. 3

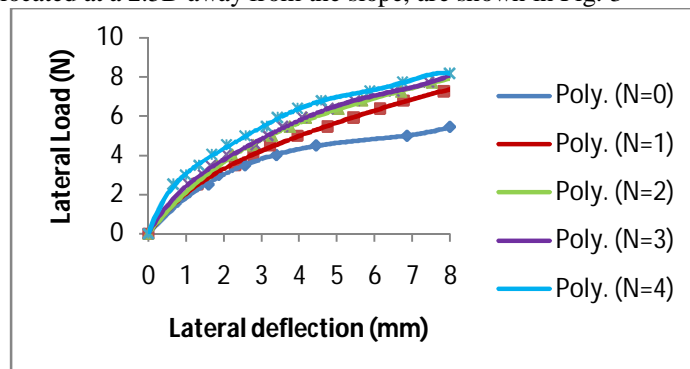

Figure 3: Load Deflection curve for Short Pile at b=2.5D and  $\theta=0^\circ$

### 2. Load Deflection Behavior of Short Pile With Lateral Load at Distance (b=5.0D)

The test was conducted on short pile of length 10 cm on prepared unreinforced slope and reinforced slope. The load deflection curves for pile with different number of geogrid layers (N) viz., 1,2,3,4 resp. The angle of loading direction is kept to be 0° and pile is located at a 5D away from the slope, are shown in Fig. 4

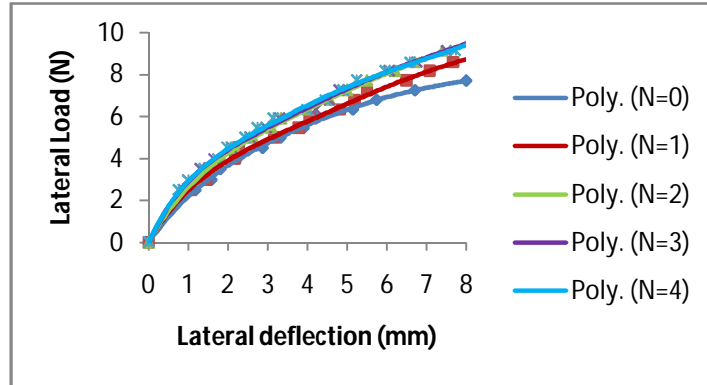

Figure 4: Load Deflection curve for Short Pile at  $b=5D$  and  $\theta=0^\circ$

**3. Load Deflection Behavior of Short Pile with Lateral Load at Distance ( $b=7.5D$ )**

The test was conducted on short pile of length 10 cm on prepared unreinforced slope and reinforced slope. The load deflection curves for pile with different number of geogrid layers (N) viz., 1,2,3,4 resp. The angle of loading direction is kept to be  $0^\circ$  and pile is located at a  $7.5D$  away from the slope, are shown in Fig. 5

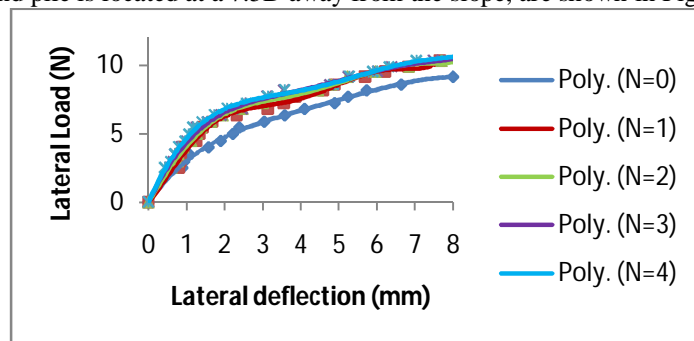

Figure 5: Load Deflection curve for Short Pile at  $b=7.5D$  and  $\theta=0^\circ$

**4. Load Deflection Behavior of Short Pile with Inclined Load( $15^\circ$ ) at Distance ( $b=2.5D$ )**

The test was conducted on short pile of length 10 cm on prepared unreinforced slope and reinforced slope. The load deflection curves for pile with different number of geogrid layers (N) viz., 1,2,3,4 resp. The angle of loading direction is kept to be  $15^\circ$  and pile is located at a  $2.5D$  away from the slope, are shown in Fig. 6.

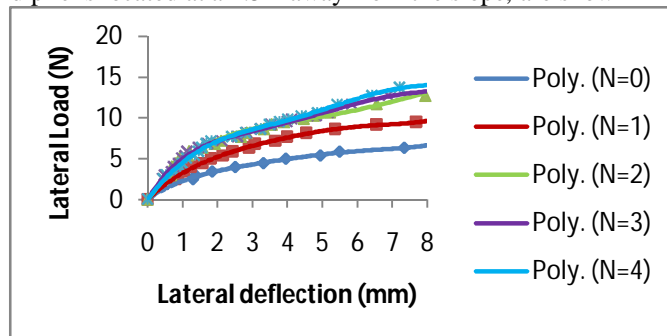

Figure 6: Load Deflection curve for Short Pile at  $b=2.5D$  and  $\theta=15^\circ$

**5. Load Deflection Behavior of Short Pile with Inclined Load(15°) at distance (b=5D)**

The test was conducted on short pile of length 10 cm on prepared unreinforced slope and reinforced slope. The load deflection curves for pile with different number of geogrid layers (N) viz., 1,2,3,4 resp. The angle of loading direction is kept to be 15° and pile is located at a 5D away from the slope, are shown in Fig. 7.

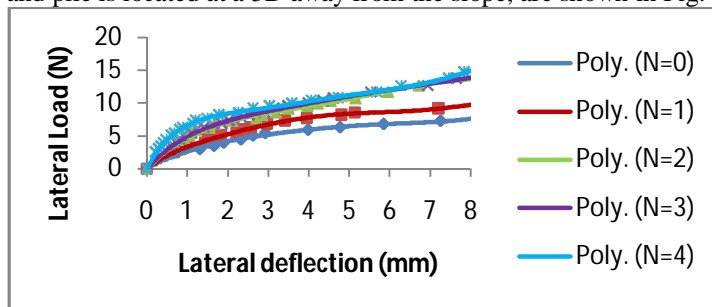

Figure 7: Load Deflection curve for Short Pile at b=5D and  $\theta=0^\circ$

**6. Load Deflection Behavior of Short Pile with Lateral Load at Distance (b=7.5D)**

The test was conducted on short pile of length 10 cm on prepared unreinforced slope and reinforced slope. The load deflection curves for pile with different number of geogrid layers (N) viz., 1,2,3,4 resp. The angle of loading direction is kept to be 15° and pile is located at a 7.5D away from the slope, are shown in Fig. 8.

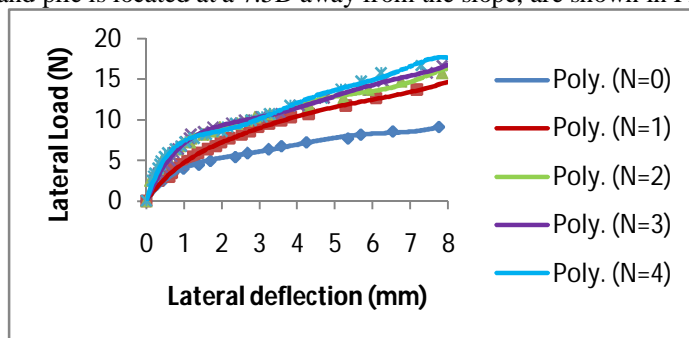

Figure 8: Load Deflection Curve for Short Pile at B=7.5D And  $\theta=0^\circ$

**7. Load Deflection Behavior of Short Pile with Inclined Load(30°) at Distance (B=2.5D)**

The test was conducted on short pile of length 10 cm on prepared unreinforced slope and reinforced slope. The load deflection curves for pile with different number of geogrid layers (N) viz., 1,2,3,4 resp. The angle of loading direction is kept to be 30° and pile is located at a 2.5D away from the slope, are shown in Fig. 9.

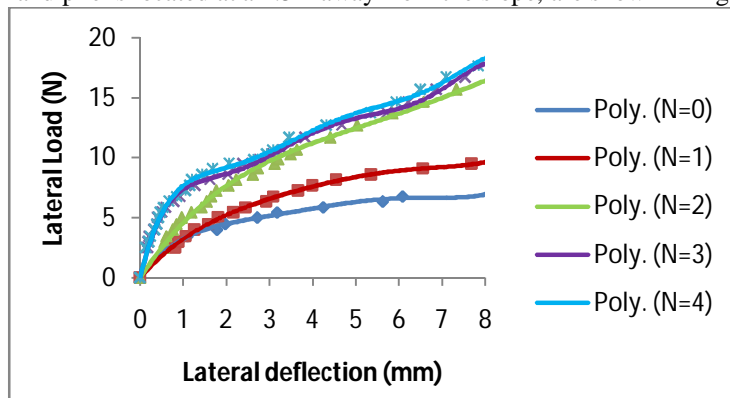

Figure 9: Load Deflection curve for Short Pile at b=2.5D and  $\theta=30^\circ$

**8. Load Deflection Behavior of short pile with inclined load(30°) at distance (b=5D)**

The test was conducted on short pile of length 10 cm on prepared unreinforced slope and reinforced slope. The load deflection curves for pile with different number of geogrid layers (N) viz., 1,2,3,4 resp. The angle of loading direction is kept to be 30° and pile is located at a 5D away from the slope, are shown in Fig. 10.

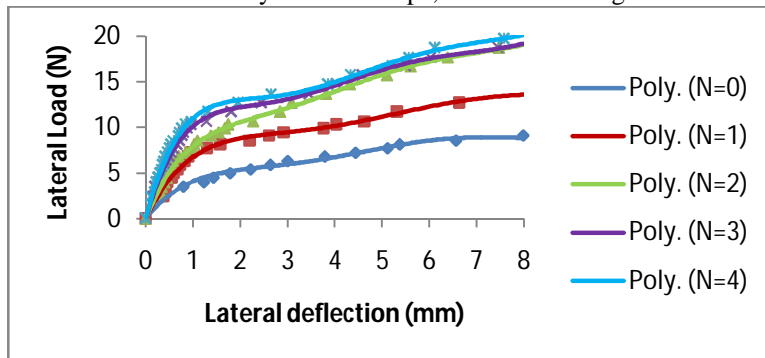

Figure 10: Load Deflection Curve for Short Pile at B=5D And  $\theta=30^\circ$

**9. Load Deflection Behavior of Short Pile with Lateral Load at Distance (b=7.5D)**

The test was conducted on short pile of length 10 cm on prepared unreinforced slope and reinforced slope. The load deflection curves for pile with different number of geogrid layers (N) viz., 1,2,3,4 resp. The angle of loading direction is kept to be 30° and pile is located at a 7.5D away from the slope, are shown in Fig. 11

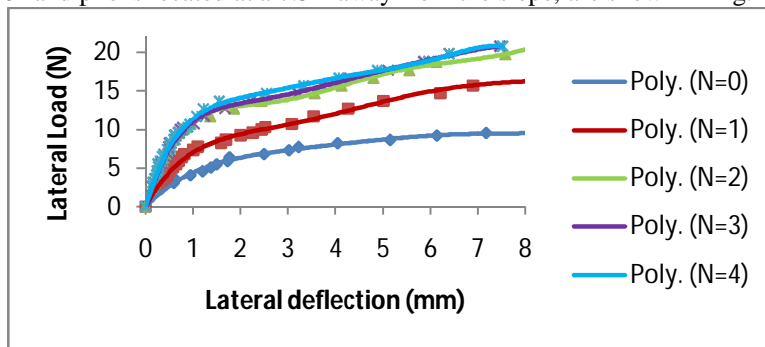

Figure 11: Load Deflection curve for Short Pile at b=7.5D and  $\theta=30^\circ$

Table 4.5.2: Ultimate Lateral Load of Short Pile

Crest Distance	N=0	N=1	N=2	N=3	N=4
For 0° Inclination					
2.5D	4.8	5.6	6.3	6.4	6.4
5D	6.2	6.7	7.25	7.3	7.4
7.5D	7.5	8.7	8.8	8.9	9.0
For 15° Inclination					
2.5D	5.5	7	10.2	10.4	10.5
5D	6.5	8.4	10.5	10.8	11.0
7.5D	7.7	11.2	12.5	12.8	13
For 30° Inclination					
2.5D	6.3	8.1	12.7	13	13.5
5D	7.6	11	15.5	16.3	16.8
7.5D	8.5	13.7	17.0	17.2	17.4



# International Journal of Innovative Research in Science, Engineering and Technology

(An ISO 3297: 2007 Certified Organization)

Vol. 5, Issue 6, June 2016

## V. COCLUSION

- i) Reinforcement of an earth slope using geogrid has a significant effect on improving the ULL(Ultimate Lateral Resistance) of single pile located near the slope crest.
- ii) The improvement in ULL is dependent on the location of pile, the embedded length of pile and number of geogrid layers.
- iii) For short pile, 2 no. of geogrid layers are found optimum.
- iv) The max. percentage increase in ULL is **104%** for optimum number of geogrid layer, N=2 for short pile .
- v) he ULL increases as the crest distance increases and the rate of increase is nearly linear.
- vi) The max. percentage increase in ULL is **69%** for short pile, when pile is placed at crest distance,  $b=7.5D$ .
- vii) The ULL improves with the increase in inclination angle of loading from  $0^\circ$  to  $30^\circ$  and increment in ULL is nearly linear.
- viii) The max. percentage increase for short pile at  $15^\circ$  inclination is **64%** and at  $30^\circ$  inclination is **127%**.

## REFERENCES

- [1] Reese, C., Cox, W. R., and Koop, F. D., "Analysis of laterally loaded piles in sand", Proc. 6<sup>th</sup> offshore technology conference, paper 2080, houston, texas, pp. 473-483, (1974).
- [2] Mirzoyan, A. D., "Lateral resistance of piles at the crest of slope in sand".M.s. Thesis, brigham young university, department of civil and environmental engineering, utah, (2007)
- [3] Nimityongskul, N., "Effects of soil slope on lateral capacity of piles in cohesive soils." Ph.d. Dissertation, dept.Of civil and construction engineering.Oregon state university, (2010).
- [4] Sawwaf,E. M.(2006). "Lateral resistance of single pile located near geosynthetic reinforced slope", Journal of geotechnical and geoenvironmental engineering © asce / October.
- [5] Chae, K.S., Ugai, K., and Wakai, A. (2004). "Lateral resistance of short single piles and pile groups located near slopes.",International journal of geomechanics, 4(2), 93-103.