

Design and Analysis of Re-Configurable Dual Band-Notched Micro-Strip Wide-Band Antenna

Mujtaba Afzal¹, Dayal Sati², Heena Choudhary³, Tejbir Singh⁴

M. Tech Scholar, Assistant Professor²; Dept. of Electronics & Communication Engineering, BRCM College of Engineering & Technology, Bahal-Haryana, India^{1,2}

Assistant Professor, Dept. of Electronics & Communication Engineering, Swami Vivekananda Subharti University, Meerut, India³

Assistant Professor, SRM University Delhi-NCR, Sonapat, India⁴

ABSTRACT: In this paper, a compact re-configurable dual band notched wide-band antenna that is suitable for underlay and overlay UWB cognitive radio is proposed. Ultra wide-band cognitive radio (UWB-CR) features the use of UWB transmission as the enabling technology for cognitive radio, in both the underlay and overlay spectrum sharing approaches. The antenna can be operated as ultra wide-band, for underlay CR and for sensing in the overlay CR, and is re-configurable in terms of the ability to selectively have a band notch in the Wi-MAX and WLAN bands, to prevent interference to primary users operating in these bands, when used in the overlay CR mode. By etching out two CSRR of different dimensions in the radiating patch, two band-notched properties in the Wi-MAX (3-3.7 GHz), WLAN (5.125-5.825 GHz) are obtained. The realized antenna achieved an operating bandwidth (VSWR < 2) ranges from 2.72 to more than 25 GHz with double notched bands of 3.3-3.82GHz and 4.79-5.8 GHz. The proposed antenna is well designed and extensively investigated. The simulation results are given to verify that the proposed antenna with a wide bandwidth is suitable for modern high data rate UWB communication applications. The maximum measured gain for the fabricated antenna is around 11.34 dBi with an average efficiency above 88.97% throughout the bandwidth.

KEYWORDS: Ultra Wide Band (UWB), Circular Split Ring Resonator (CSRR), Cognitive Radio, Notch Band, Opportunistic Spectrum Access (OSA), Wi-MAX, WLAN

I. INTRODUCTION

Ultra wideband (UWB) technology has gained a lot of popularity among researchers and the wireless industry after the FCC permitted its marketing within the frequency band of 3.1 GHz to 10.6 GHz [1]. The attractiveness of UWB is in its capability of offering high capacity, short-range wireless communication links using low-cost low-energy transceivers. To establish the communication between two nodes, these transceivers require UWB antennas, preferably of small size and low manufacturing cost.

Because of the existence of narrow band communication systems like IEEE 802.16 Wi-MAX (3.3–3.8GHz), IEEE 802.11a WLAN (5.15–5.85 GHz), an additional requirement for UWB antennas is to reject some bands within the ultra wide pass-band. In these cases, UWB antennas with notched characteristics at certain bands are desired. Integration of external band-stop filters; to achieve the desired band rejection increases system complexity and size. Hence, in order to keep the antenna footprint unaltered, designers have resorted to the approach of embedding parasitic strips or slots of different shapes in the radiating element or ground plane of the antenna systems [2]–[5].

International Journal of Innovative Research in Science, Engineering and Technology

(An ISO 3297: 2007 Certified Organization)

Vol. 5, Issue 6, June 2016

The main problem of band rejection design is the difficulties of controlling the bandwidth of the notched band in a limited antenna space. Moreover, while adequate band rejection is highly desirable, the performance of the antenna should remain essentially the same for the rest of the band.

II. RELATED WORK

Recently, a number of UWB antennas with band-notched properties were presented where various methods have been used to achieve the band notching. Examples of approaches used are:

- Inverted U-shaped slots and H-shaped slot [6],
- U-shaped slots and E-shaped slot [7],
- folded strip line slot and a pair of inverted L-shaped slots [8],
- Half-wavelength C-shaped slot in the patch and two half-wavelength stepped impedance resonators around the feed-line [9],
- Three open-ended quarter-wavelength slots [10],
- L-shaped two slots and open-loop resonator [11], and
- Stepped impedance resonator-defected ground structure (SIR-DGS) and fork-shaped stubs [12].

The performances of band-notching techniques used have been recently compared in [13]. Also the growing popularity of wireless connectivity demands integration of new service bands to mobile devices. Furthermore, the consumer electronic devices such as tablet computers and smart phones become highly prevalent in this decade. These advancements in wireless communication result in radio spectrum congestion, and the effective use of available spectrum becomes vital [14], [15]. One of the effective solutions for this challenge is the implementation of a cognitive radio system. Cognitive Radio (CR) [16] is expected to revolutionize the way spectrum is allocated. In a CR network following the hierarchical access model [17], the intelligent radio part allows unlicensed users (secondary users) to access spectrum bands licensed to primary users, while avoiding interference with them.

In OSA model, two approaches to spectrum sharing between primary and secondary users have been considered:

(a) **Spectrum underlay** - In the underlay approach, secondary users should operate below the noise floor of primary users, and thus severe constraints are imposed on their transmission power (should be less than -42dBm/MHz). One way to achieve this is to spread the transmitted signals of secondary users over an ultra-wide frequency band, leading to a short-range high data rate with extremely low transmission power.

(b) **Spectrum overlay** - The spectrum overlay (OSA) approach imposes restrictions on when and where secondary users may transmit rather than their transmission power. In this approach, secondary users avoid higher priority users through the use of spectrum sensing and adaptive allocation. They identify and exploit the spectrum holes defined in space, time, and frequency. The underlay and overlay approaches in the hierarchical model are illustrated in Fig. 1. They can be employed simultaneously for further spectrum efficiency improvement.

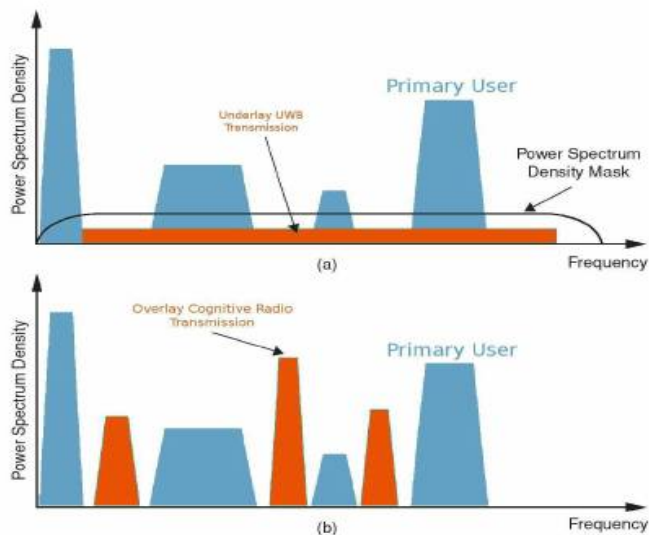

Fig.1 Underlay & overlay approaches

In the overlay UWB scenario, the antenna at the front-end of the Cognitive Radio device should be capable of operating over the whole UWB range, for sensing and determining the bands that are being used by primary users, but should also be able to induce band notches in its frequency response to prevent interference to these users. For underlay UWB cognitive radio, the antenna should be ultra wide-band, with no band notches needed [18].

In this paper, we propose a compact (19×32) mm² Wide-Band antenna that is suitable for both underlay and overlay UWB cognitive radio. It can be operated as simply a wide-band antenna, and it is re-configurable in terms of the ability to selectively have band stops in the Wi-MAX (3.5GHz) and WLAN (5.2GHz) bands.

The proposed antenna is designed using Ansoft's High Frequency Structure Software (HFSS).

Section III presents the geometry, the antenna model and various antenna dimensions. Section IV discusses the simulated and the experimental results performed and Section V is summarized the final conclusions of this study.

III. ANTENNA DESIGN

This section describes the antenna geometry and the design process. A full wave analysis of the proposed structures is obtained by using the electromagnetic software, Ansys HFSSTM v13.1 which is based on Finite element method (FEM) numerical technique. The design goals are to achieve impedance bandwidth cover the wide frequency spectrum with good gain, stable radiation patterns across the whole desired band excluding the rejected band (the band-notch) that obtained by two different techniques.

A. Antenna geometry

The proposed antenna is described in this section. The design starts with a micro-strip patch antenna where Figure 2(a) demonstrates the top view & Figure 2(b) depicts bottom view of proposed reconfigurable band notched antenna structure with slots inserted at the partial ground plane.

The antenna is printed on 19mm × 32mm FR4 epoxy substrate with the relative permittivity $\epsilon_r = 4.4$, a loss tangent $\tan \delta = 0.02$ and a thickness $h = 1$ mm. It is composed of a 50Ω micro-strip feed line with the width of W_f and length of L_f to couple the input signal to the radiating patch, a planar modified triangular shaped radiating patch with two complementary split ring resonators and partial rectangular ground plane with a rectangular shaped slot.

Several aspects were considered to optimize the final design like the overall impedance bandwidth of the antenna, the bandwidth of the notched bands, and the level of band rejection at notched frequency.

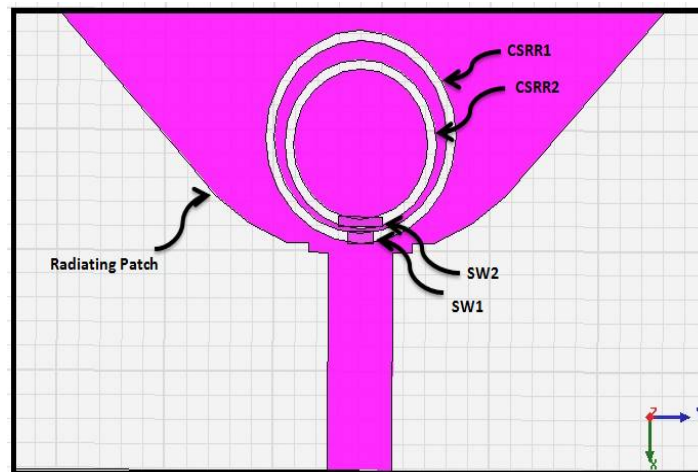

(a) Top-view

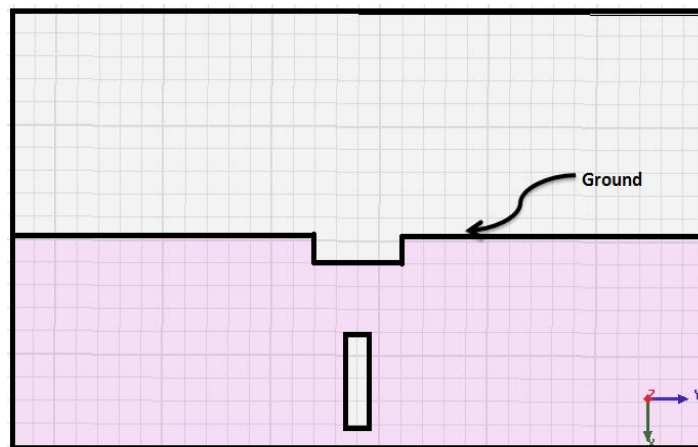

(b) Bottom-view

Fig.2 Geometry of proposed antenna

The optimal antenna parameters are tabulated in Table1. Proper impedance matching produces the best return loss at the wanted frequency. In the micro-strip feed line, the impedance of the micro-strip line is given by [19]-

$$Z_c = \frac{120 \Pi}{\sqrt{\epsilon_{reff}}} \left[\frac{1}{\frac{Wf}{h} + 1.393 + 0.667 \ln \left(\frac{Wf}{h} + 1.444 \right)} \right] \quad (1)$$

International Journal of Innovative Research in Science, Engineering and Technology

(An ISO 3297: 2007 Certified Organization)

Vol. 5, Issue 6, June 2016

Table 1: Dimension of the designed antenna

Parameter	Dimension (mm)	Parameter	Dimension (mm)
W_{sub}	32	W_{g1}	4
L_{sub}	19	W_{g2}	1
W_f	3	W_{slot}	0.3
L_f	9.016	W_1	0.9
h	1	W_2	1
L_g	9.3	W_p	28
L_{g1}	5	R_1	4.3
L_{g2}	4	R_2	3.1
L_{g3}	1.2		

The analysis of the proposed antenna structure is based on transmission line modal analysis. Figure 3 shows the geometry of proposed antenna structure used for simulation in next section.

Larger CSRR is etched out to obtain a single band-notched antenna structure. To get this first band-notch at 3.5 GHz within the Wi-MAX band (3.3–3.7 GHz), we choose $R_1 = 3.6$ mm and centre of the resonating structure at (-4.3, 0, 1). Another smaller CSRR element with $R_2 = 4.5$ mm and centered at (-4, 0, 1); is etched out to obtain second notch band at 5.5 GHz within the WLAN band (5.15–5.85 GHz).

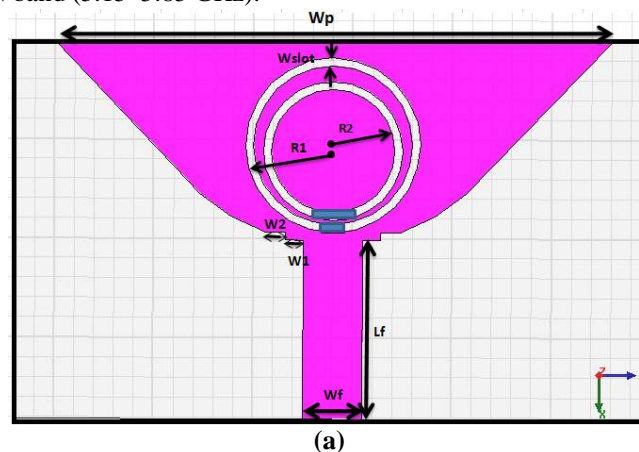

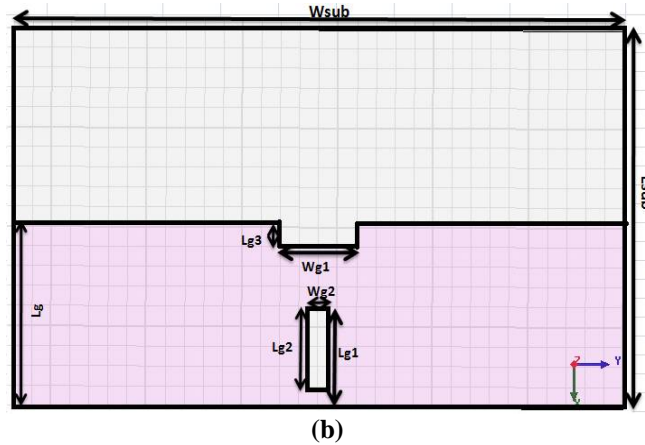

Fig.3.Geometry of (a) Radiating patch & CSRR (b) Ground & Substrate

III. SIMULATION RESULTS AND DISCUSSION

The analysis of proposed antenna is done using the simulation performed on Ansys HFSS EM simulator for the frequency range of 1 to 28 GHz. During the simulation and measurement, the presence of a metal bridge represents ON state and the absence of a metal bridge represents OFF state [8].

The various switch configurations are tabulated in table no. 2.

Table 2. Switches and their respective frequency tuning

Switch Configuration	Function
Configuration I - (All OFF)	Wide-band antenna
Configuration II - (S1-ON) (S2-OFF)	Single band notch wideband antenna
Configuration III - (S1-ON) (S2-ON)	Double band notch wideband antenna

Figure 4 shows the simulated VSWR of proposed wide-band antenna structure in switch configuration I.

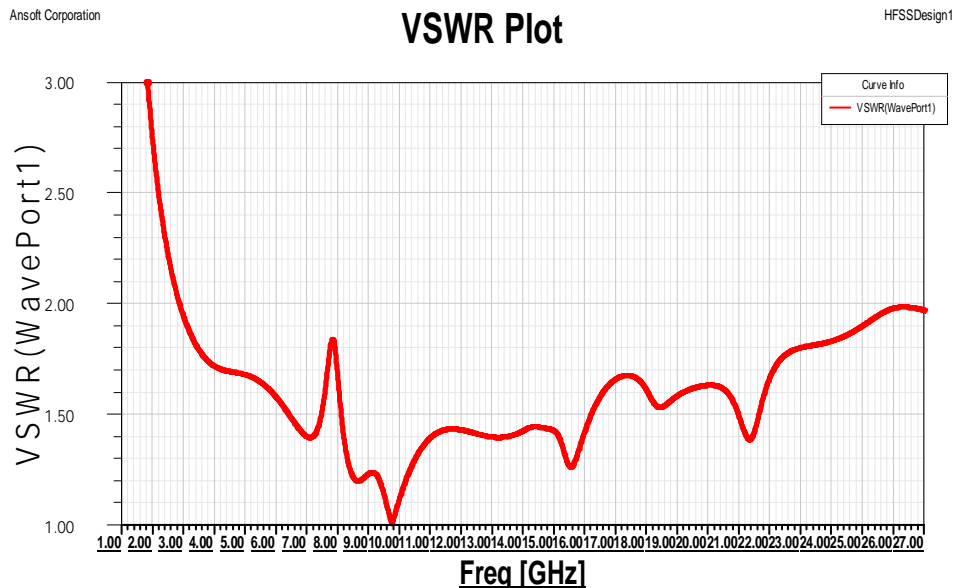

Fig.4 Graph of simulated VSWR characteristics of the proposed UWB antenna structure in switch configuration I.

From the plot of simulated VSWR Vs frequency of proposed antenna structure, it is seen that antenna covers wide bandwidth i.e. 2.9-26.05 GHz for VSWR < 2 dB for the switch configuration I.

Figure 5 shows the simulated VSWR of wide-band antenna structure in switch configuration II.

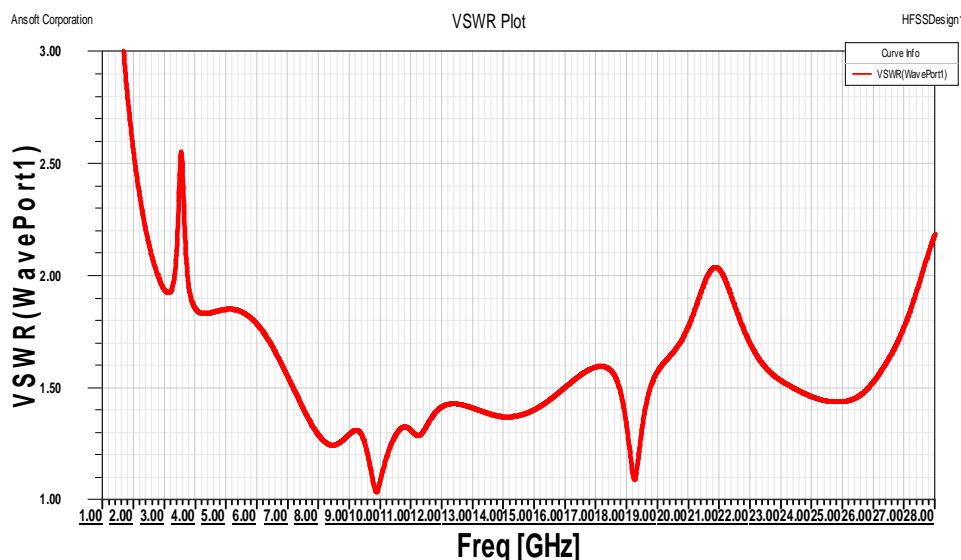

Fig.5 Graph of simulated VSWR characteristics of the proposed UWB antenna structure in switch configuration II.

It can be seen that the proposed antenna ;in switch configuration II (SW1-ON); is a single band notched UWB antenna, which has a bandwidth ranging from 2.7 GHz to 27.34 GHz with the VSWR less than 2 except a notch band 3.3 to 3.74 GHz.

The simulated VSWR of wide-band antenna structure in switch configuration III is depicted in figure 6.

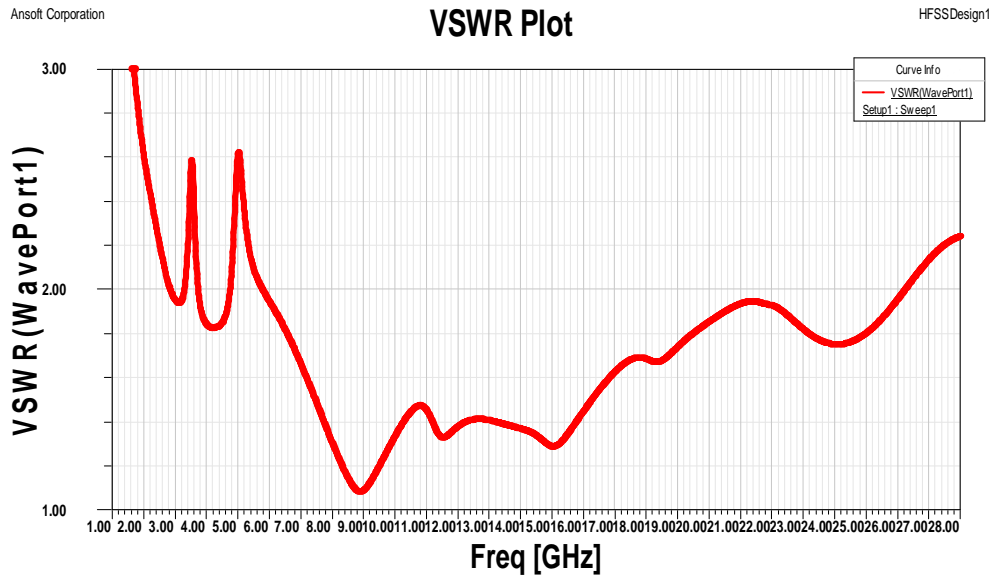
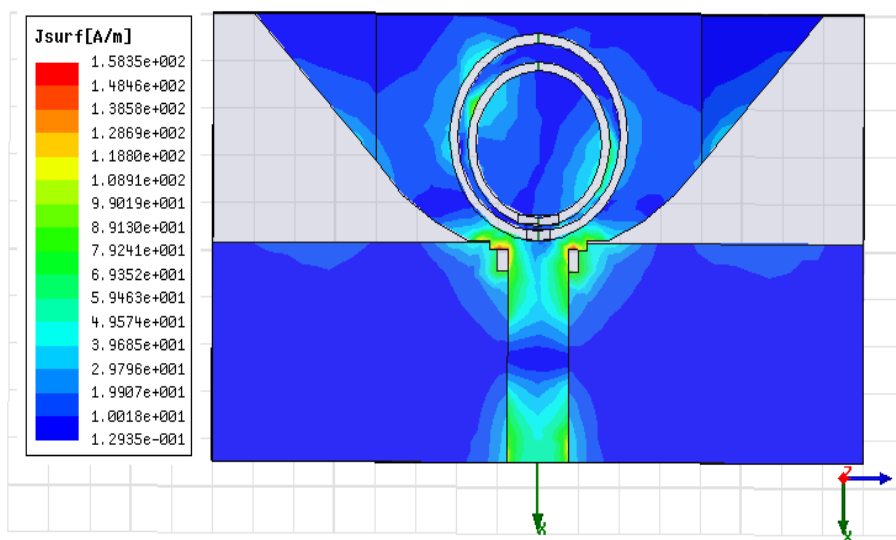

Fig.6. Graph of simulated VSWR characteristics of the proposed UWB antenna structure in switch configuration III.

It can be seen that when both switches are in ON state, antenna structure has two CSRR etched in the radiating patch, it can give two notch bands at 3.5 GHz and 5.2 GHz to filter out the potential interferences from Wi-MAX and WLAN communication systems.

The simulated surface current distributions of the proposed antenna in three switch configurations are shown in Figure 7. Figure 7(a) depicts the surface current distribution when both switches are in OFF state.



(a)

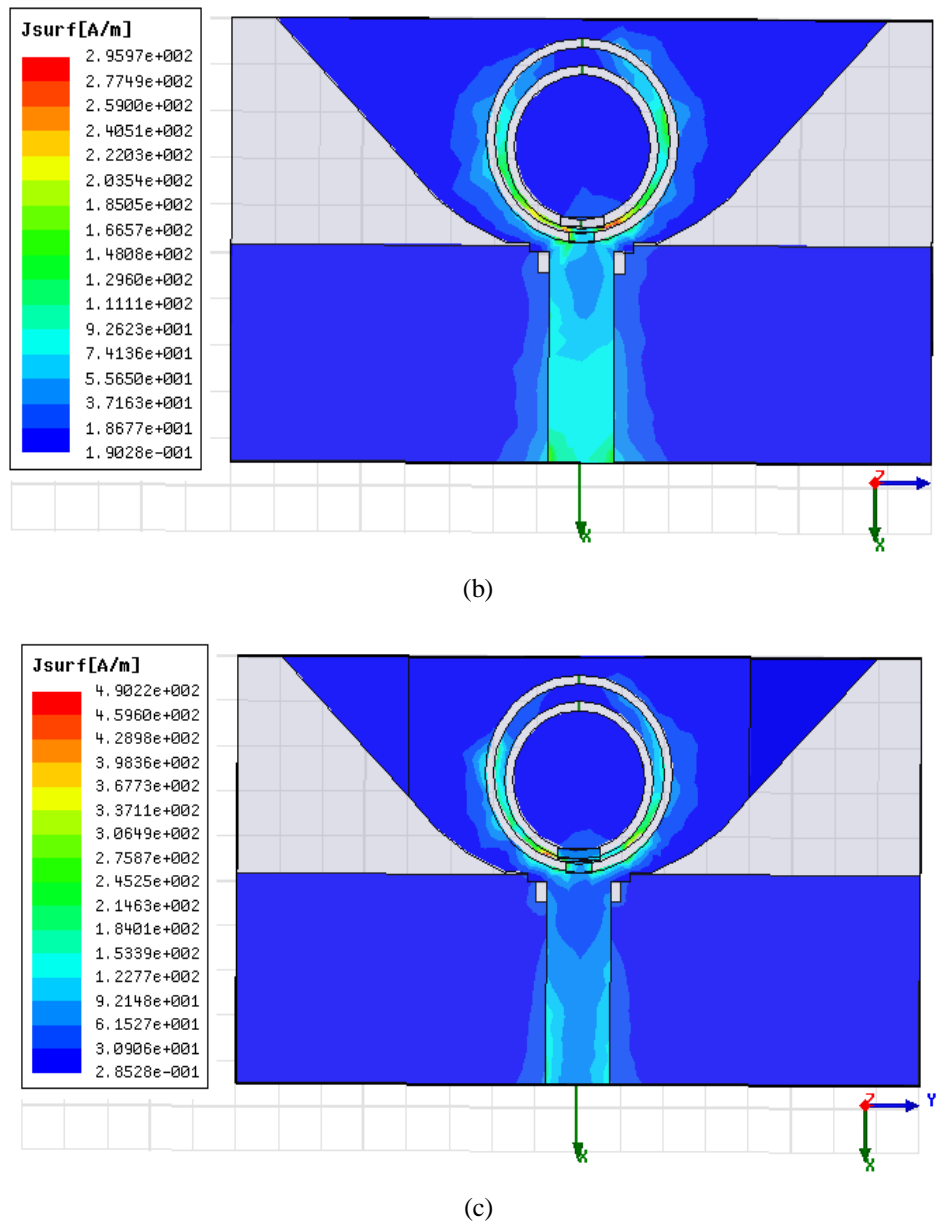

Fig.7. Simulated current distributions for proposed antenna structure in (a) switch configuration I at 8.18 GHz (b) switch configuration II at 3.4 GHz (c) switch configuration III at 5.5 GHz

As shown in Figure 7(b), the current at 3.4 GHz is mainly distributed around outer CSRR.

The current distribution at 5.5 GHz is mainly concentrated around the inner CSRR element as shown in Figure 7(c).

The measured radiation patterns in the E- (x-y) and H- (x-z) plane in various switch configurations are plotted in Figure 8. It can be seen that the proposed antenna has a nearly Omni-directional radiation pattern in the H-plane and a dipole-like radiation pattern in the E-plane.

Ansoft Corporation **Radiation Pattern at 8.91 GHz** HFSSDesign1

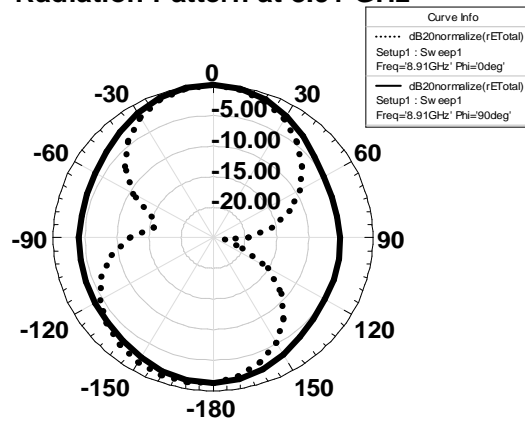

(a)

Ansoft Corporation **Radiation Pattern 3.52GHz** HFSSDesign1

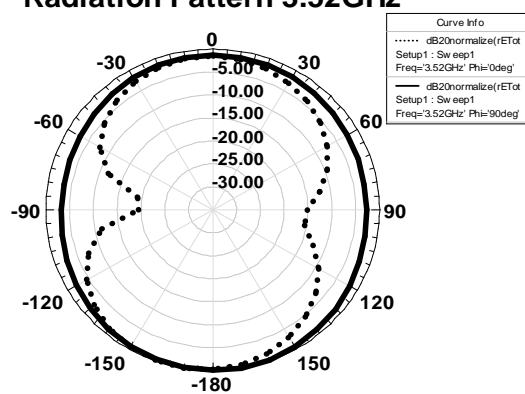

(b)

Ansoft Corporation **Radiation Pattern 5.18GHz** HFSSDesign1

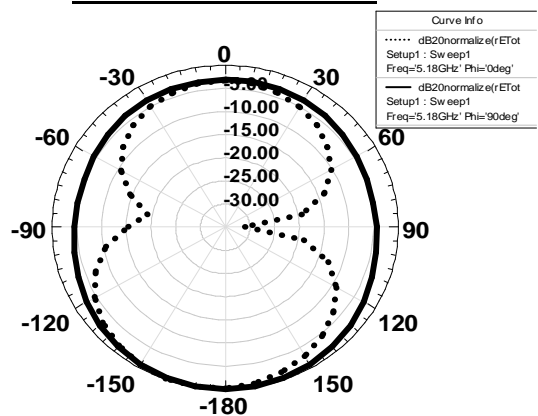

(c)

Fig.8. Simulated radiation pattern of the proposed antenna in (a) switch configuration I at 8.91 GHz [pass-band frequency] (b) switch configuration II at 3.52 GHz [notch frequency] (c) switch configuration III at 5.18 GHz [notch frequency]

International Journal of Innovative Research in Science, Engineering and Technology

(An ISO 3297: 2007 Certified Organization)

Vol. 5, Issue 6, June 2016

IV. CONCLUSION

A compact reconfigurable double band-notched wide band antenna has been presented and well designed by the use of the EM simulator HFSSTM v13. The notch bands are achieved by etching two CSRR in radiating patch. From the simulation, we found that the proposed antenna can prevent the potential interference from Wi-MAX and WLAN narrow-band technologies. The results showed that the proposed antenna has a wide bandwidth ranging from 2.72 GHz to 25.9 GHz rejecting the undesired narrow-band signals from Wi-MAX (3.3-3.8GHz) and WLAN (4.7-5.8 GHz). A prototype antenna is planned to be fabricated by the authors using low-cost FR4-Epoxy substrate for further work relating to this Paper.

REFERENCES

- [1] Federal Communications Commission, "Revision of Part 15 of the commission's rules regarding ultra wide-band transmission systems", first note and order," ET-Docket 98-153, Washington, DC, 2002.
- [2] J. Kim, C.S. Cho. And J.W.Lee, "5.2GHz notched ultra wide-band antenna using slot-type SRR," Electron. Letter, vol.42, no.6, pp.315–316, Mar. 2006.
- [3] Q. X. Chu and Y. Y. Yang, "A compact ultra wide-band antenna with 3.4/5.5GHz dualband-notched characteristics," IEEE Trans. Antennas Propagation, vol. 56, no. 12, pp. 3637–3644, Dec. 2008.
- [4] H. Zhang, R. Zhou, Z. Wu, H. Xin, and R. W. Ziolkowski, "Designs of ultra wide-band (UWB) printed elliptical mono pole antennas with slots," Microwave Opt. Technol. Letter, vol. 52, no. 2, pp. 466–471, Feb. 2010.
- [5] D. Sarkar and K. V. Srivastava, "SRR-loaded antipodal Vivaldi antenna for UWB applications with tunable notch function," in Proc. URSI Commission BEMTS, Hiroshima, Japan, 2013, pp.466–469.
- [6] Lee, W. S., D. Z. Kim, K. J. Kim, and J. W. Yu, "Wide-band planar monopole antennas with dual band-notched characteristics," IEEE Transactions on Microwave Theory & Techniques, Vol. 54, No. 3, 2800–2806, 2008.
- [7] Li, Y. S., X. D. Yang, C. Y. Liu, and T. Jiang, "Compact CPW-fed ultra wide-band antenna with dual band-notched characteristics," Electronics Letters, Vol. 46, No. 14, 967–968, 2010.
- [8] Jiang, J. B., Z. H. Yan, and J. Y. Zhang, "Dual band-notched ultra wide-band printed antenna with two different typed slots," Microwave and Optical Technology Letters, Vol. 52, No. 9, 1930–1933, 2010.
- [9] Chu, Q.-X. And T.-G. Huang, "Compact UWB antenna with sharp band-notched characteristics for lower WLAN band", Electronics Letters, Vol. 47, No. 15, 838–839, 2011.
- [10] Nguyen, D. T., D. H. Lee, and H. C. Park, "Very compact printed triple band-notched UWB antenna with quarter-wavelength slots," IEEE Antennas and Wireless Propagation Letters, Vol. 11, 411–414, 2012.
- [11] Wang, J. W., J. Y. Pan, X. N. Xiao, and Y. Q. Sun, "A band-notched UWB antenna with L-shaped slots and open-loop resonator," The 2013 IEEE International Conference on Applied Superconductivity and Electromagnetic Devices (ASEMD), 312–315, Beijing, Oct. 25–27, 2013.
- [12] Zhang, C., J. Zhang, and L. Li, "Triple band-notched UWB antenna based on SIR-DGS and fork-shaped stubs," Electronics Letters, Vol. 50, No. 2, 67–69, 2014.
- [13] K. H. and T. A. Najm, "Performance evaluation of band notch techniques for printed dual band monopole antennas," International Journal of Electromagnetics and Applications, Vol. 3, No. 4, 70–80, 2013.
- [14] S. Genovesi, A. D. Candia, and A. Monorchio, "Compact and low profile frequency agile antenna for multistandard wireless communication systems," IEEE Trans. Antennas Propag., vol. 62, no. 3, pp. 1019–1026, Mar. 2014.
- [15] H. Boudaghi, M. Azarmanesh and M. Mehranpour, "A frequency reconfigurable monopole antenna using switchables loaded ground structure," IEEE Antennas Wireless Propag. Lett. vol. 11, pp. 655–658, 2012.
- [16] Mitola, J. and G. Q. Maguire, "Cognitive radio: Making software radios more personal," IEEE Pers. Commun., Vol. 6, No. 4, 13–18, Aug. 1999.
- [17] Chen, K.-C. And R. Prasad, Cognitive Radio Networks, John Wiley & Sons, West Sussex, United Kingdom, 2009.
- [18] M. Al-Husseini, Y. Tawk, "Design of an Antenna with Reconfigurable Band Rejection for UWB Cognitive Radio", PIERS Proceedings, Marrakesh, MOROCCO, March 20–23, 2011
- [19] Heena Choudhary, Ashish Vats, Romika Choudhary; "Design of Frequency Reconfigurable Micro Strip Patch Antenna for Wireless Applications", International Journal of Innovative Research in Science, Engineering and Technology, Vol. 4, Issue 12, December 2015
- [20] Heena Choudhary, Ashish Vats, Romika Choudhary; "Design and Analysis of Circular Patch Micro-Strip UWB Antenna for Breast cancer Detection", International Journal of Innovative Research in Science, Engineering and Technology, Vol. 4, Issue 12, December 2015
- [21] Altaf Sharief, Ashish Vats, Heena Choudhary; "A Triple Band Notches Reconfigurable Micro-strip Fed UWB Applications Antenna", International Journal of Innovative Research in Advanced Engineering, Vol. 3, Issue 6, June 2016