

Data Transmission via Visible Light Communication (VLC) Technique

M.Lotfy Rabeh¹, Mohamed I. Gabr² and Tarek Hosny²Assistant Professor, Department of Electrical Engineering, Shobra Faculty of Engineering, Benha University, Cairo,
Egypt¹Assistant Lecturer, Department of Electrical Engineering, Al Safwa High Institute of Engineering, Cairo, Egypt²

ABSTRACT: Light Emitting Diodes are set to penetrate many areas of everyday life. An interesting property of these devices in addition to their lightening capabilities, is that they can also be utilised for data transmissions as well. LED's require low power for their operation and have very high switching speeds. This dual purpose application can reduce our dependency on the densely used means of communication the Radio frequency communication.. Visible light communication (VLC) technique using White Light Emitting Diode (LED) is a promising technology for next generation communication for short range, high speed wireless data transmission. LEDs have a number of advantages, one of which is long life expectancy. LEDs' ability to transfer information signals over light makes it a very good communication medium. Now the light we use in our daily life is not only be used for providing light but also for communication. However, like many emerging technologies, VLC has many technical issues that need to be addressed. Using visible light for data transmission entails many advantages and eliminates most drawbacks of transmission via electromagnetic waves outside the visible spectrum. In this paper, inexpensive transmitter and receiver of (VLC) system is designed and implemented experimentally for transmitting data between two computers using Hyper Terminal software.

KEYWORDS: Visible Light Communication (VLC), LED.

I. INTRODUCTION

Multimedia applications and video streaming are now extensively used in everyday life and at the same time, the great increasing in the number of mobile devices such as smart phones, laptops and tablets, everyone wants to use wireless data but capacity is drying up. wireless radio frequencies are getting higher, complexities are increasing and RF interference continue to grow, in order to overcome all of these problems in the future, researches have lead to the development of new technologies for future high capacity communication systems. These technologies such as millimetre waves, terahertz waves and optical waves. High speed data rate has been demonstrated by optical waves (Visible Light) [1],[2]. The idea of using visible light for data transmission is not entirely new. Using smoke signals to transfer messages goes back several thousand years and was used by many different cultures, e.g. Native Americans and Romans. Light houses are employed to help ships navigate through dangerous coastal areas by sending out visible beams of light in periodical intervals. "The Pharos of Alexandria" was arguably the first tower which was served as lighthouse and was one of the Seven Wonders of the World. Its construction dates back to 300 BC. The first sophisticated attempt to harness visible light for transmitting data was carried out by the Scottish scientist and inventor Alexander Graham Bell who is credited with inventing among other devices the photo phone. The photo phone was a device that allowed to transmit data on rays of sunlight and was completed in February 1880 by Bell and his assistant Charles Tainter. Using visible light for data transmission entails many advantages and eliminates most drawbacks of transmission via electromagnetic waves outside the visible spectrum. For instance, few known visible light-induced health problems exist today, exposure within moderation is assumed to be safe on the human body [2],[3].

International Journal of Innovative Research in Science, Engineering and Technology

(An ISO 3297: 2007 Certified Organization)

Vol. 5, Issue 9, September 2016

II. VISIBLE LIGHT COMMUNICATION TECHNIQUE (VLC)

- The Visible Light Communication (VLC) refers to a technology that using visible light as a Signal Transmitter, The Air as Transmission Medium and a suitable photodiode as a Signal Receiver. It uses Light between 400 THz (780 nm) and 800 THz (375 nm) as an optical carrier for data communication and illumination [4].
- The heart of this technology is the high brightness LED's [5]. Light Emitting Diode can be switched **on** and **off** faster since operating speed of LED'S is less than $1\mu s$, causing the light source to appear continuously which make a kind of data transmission using binary codes as switching "**on**" is a logical "**1**" and switching "**off**" is a logical "**0**", in other word, digital communication as shown in fig. 1.
- Visible Communication is typically implemented using white LED light bulbs. These devices are normally used for illumination by applying constant current through the LED, by fast variations of current, the optical output can be made to vary at extreme high speeds. Unseen by the human eye [5],[6], This variation is used to carry high speed data. When signals reach the receiver through the indoor wireless channel, the photodiode will convert the optical signals to electrical ones and the original information will be recovered. The visible light communication based on LED is a novel developing technique in the optical wireless communication field [7].

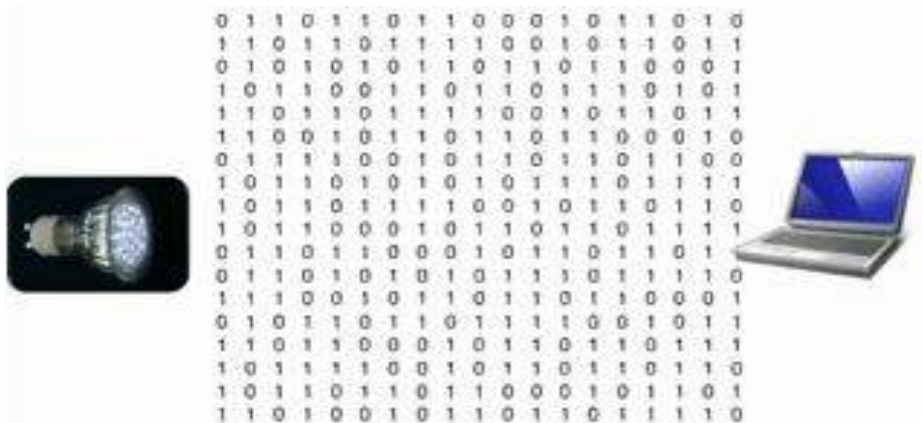

Fig. 1 shows if the light is on then transmit a digital 1, if it's off transmit a 0. The LEDs can be switched on and off very quickly which gives nice opportunities for transmitting data.

VLC provides cable free communication also it has a great advantages like it causes no Interference with Radio Frequency (RF) devices, Safety, Band Licensing-Free so it is considered to be a safe alternative to radio frequencies that it can be used in hospitals, space stations and other electromagnetic interference sensible locations as shown in fig.2. [8], [9], [10].

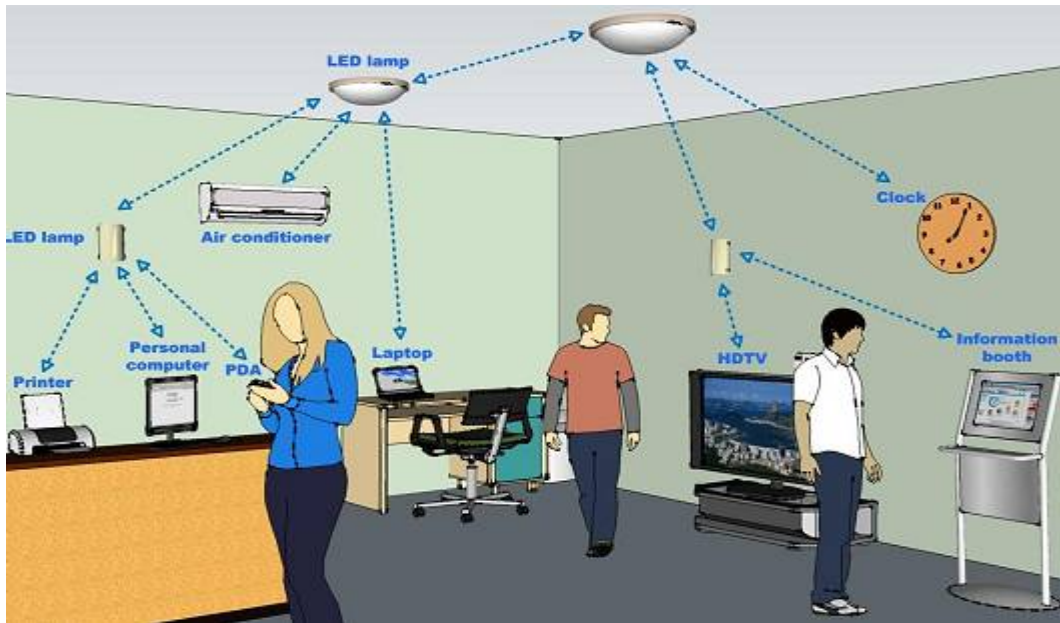

Fig. 2 Visible Light Communication environment.

Figure 2 , shows VLC Environment which connects LED Lamp (Data source) with Air Conditioner , Printer, Personal Computers, Laptops, HDTV , PDA , Clock and Information booth.

III. DESIGN AND IMPLEMENTATION

A. The VLC Block Diagram:

Fig. 3 shows block diagram of the desired transceiver system which it consists of two parts , the first part is the transmitter section which contains a computer (1) works as data source , buffer , amplifier and white LED which transmits sends data by flashing light at speeds undetectable to the human eye [11],[12]. This signal reach the receiver , the second part , and the phototransistor will convert the optical signal to electrical ones and the original signal will be recovered and appeared at computer (2) and the inverse operation is also done if we want to send data from computer (2) to computer (1) , where it is a Transceiver VLC system.

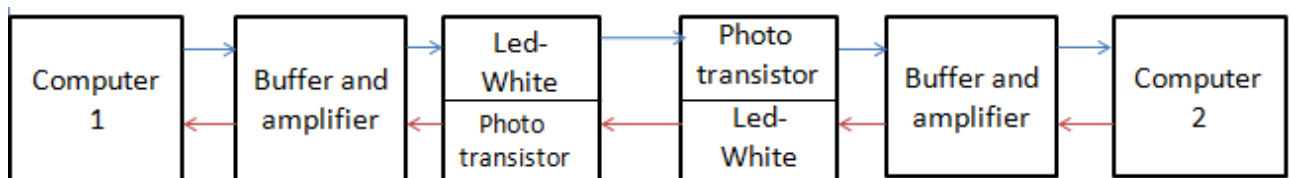

Fig. 3 Block Diagram of the transceiver VLC system which consists of Computer (1) works as transmitter and receiver , Buffer and amplifiers , White LED , Photodiode and finally Computer (2) which works as transmitter and receiver .

International Journal of Innovative Research in Science, Engineering and Technology

(An ISO 3297: 2007 Certified Organization)

Vol. 5, Issue 9, September 2016

B. Schematic Design:

The following figure represents the circuit diagram of our circuit as shown in fig. 4 and follow it the circuit operation:

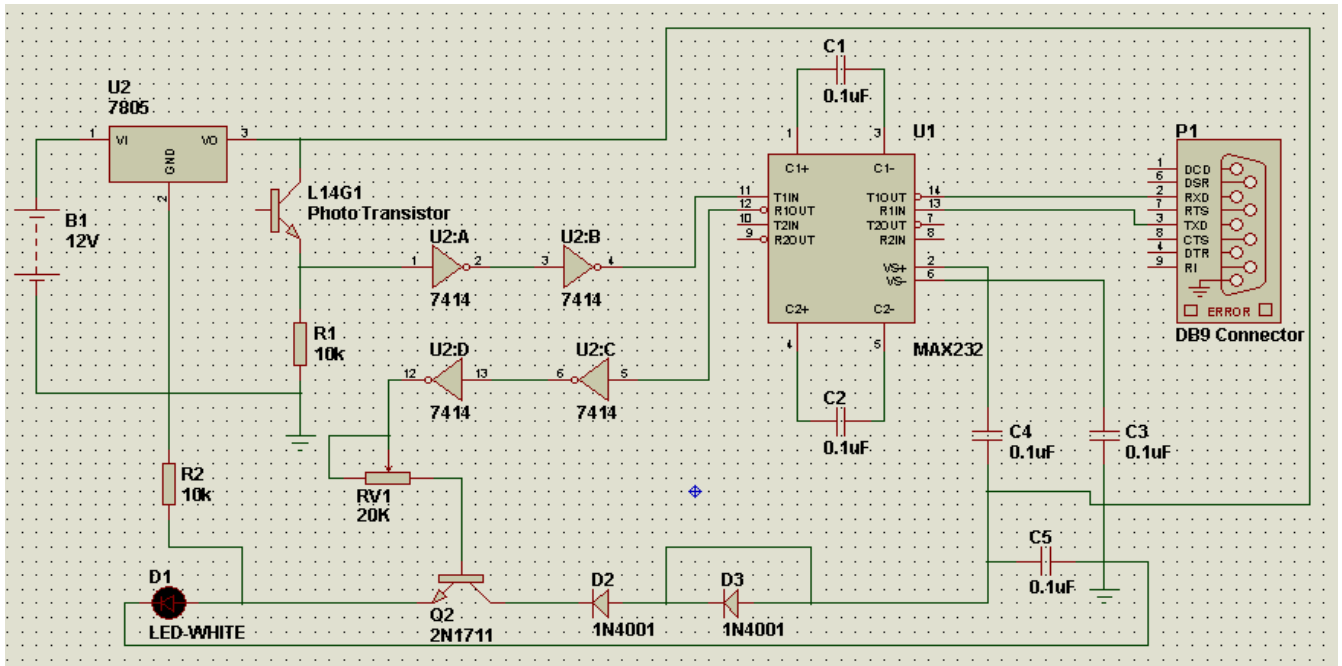

Fig. 4 Schematic Design of the transceiver VLC system which shows DB9 connector connected to MAX232 to a group of inverters to White LED and then to phototransistor.

Circuit operation :

AT TRANSMITTER :

As shown in fig .4 , through DB9 pin no.3 output data in Low current -15 to +15V (by computer original not USB to serial converter) or by USB to Serial converter 5v to Max-232 IC pin no.13 where signal convert to TTL level 5V to further circuit require .. through pin 12 we get TTL output and feed to buffer noise free output at pin no.8 of IC7414 where it is connected to base of transistor for very high current and voltage amplification which can drive LED .You can take high voltage/current MOSFET to drive hundreds of LED to transmit a data as well, Now Circuit is Ready to transmit.

AT RECEIVER :

Likely in circuit through Photo transistor LED feed in there is fluctuations or I can say through Rs-232 communication protocol relevant signal are coming where Light switch on and off in higher speed where human eye can't detect there switching, these data switch/trigger Schmitt-Trigger IC 7414 Pin no.1 and invert to pin no.2 and again pin no.3 to revert process . we are doing this to amplify signal to first stage Pin no.2 and make amplified signals with reduced noise original signal to pin no.4 then signal goes to pin no.11 of max-232 IC where high voltage / uneven signals processed to TTL level of 5V processed and out to pin no.14 of max-232 IC where it is connected with receive (RX) pin no.2 of DB9 connector. Now these signal are ready to be processed by any software application like hyper terminal program.

International Journal of Innovative Research in Science, Engineering and Technology

(An ISO 3297: 2007 Certified Organization)

Vol. 5, Issue 9, September 2016

C. CIRCUIT HARDWARE PROTOTYPE

The current prototype is shown in figure 5(a) and figure 5(b).it consists of MAX 232 level converter which converts RS-232b voltage level to TTL voltage level and TTL voltage level to RS-232 voltage level , white LED for the transmission of data , USB to RS232 cables and phototransistor for detecting the data from the visible light.

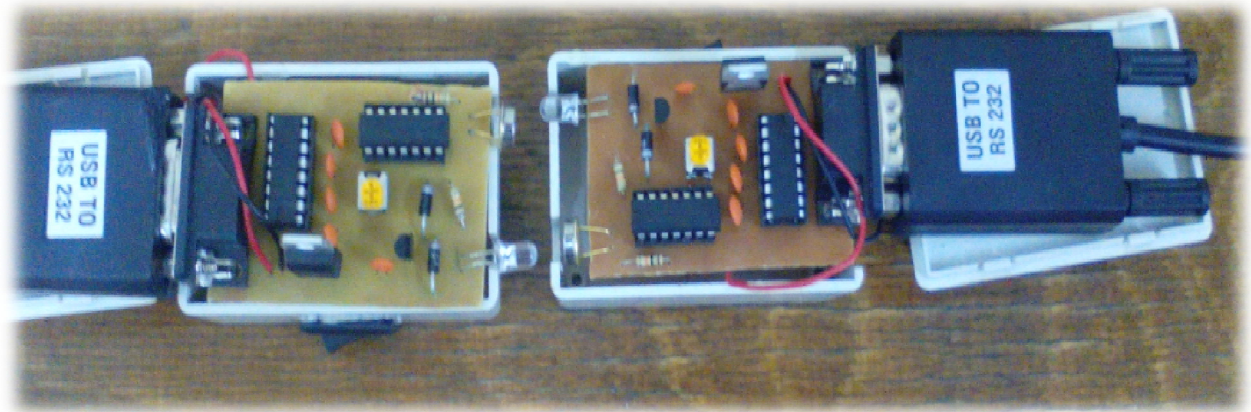

Fig. 5 (a) VLC System before connecting to power and computers , the left hand side is the transmitter circuit (or receiver) connected to USB to RS 232 Cable to computer (1) and the right hand side is the receiver circuit (or transmitter) connected to USB to RS 232 Cable to computer (2) and data transmission is occurred.



Fig. 5 (b) VLC System (the same system above) after connecting power to both circuits

IV. EXPERIMENTAL RESULTS

A- AT TRANSMITTER

Figure 6 shows the output signals when testing the implemented system at different pins of IC 7414 and MAX 232 IC . Fig. 6 (a) shows the output signal of MAX 232 pin 12 , Fig. 6 (b) shows the output signal of 7414 IC pin 6 and Fig. 6 (c) shows the output signal of the LED.

International Journal of Innovative Research in Science, Engineering and Technology

(An ISO 3297: 2007 Certified Organization)

Vol. 5, Issue 9, September 2016

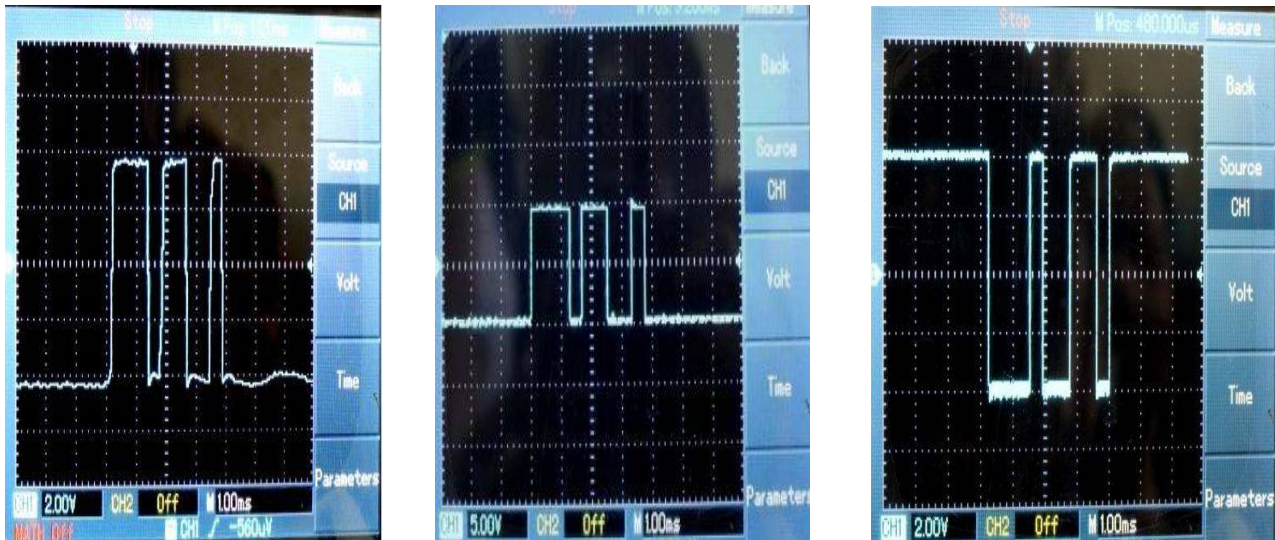

(a) (b) (c).

Fig. 6 Transmitter Section Testing (a) pin 12 of MAX 232 output signal (b) pin 6 of 7414IC output signal (c) LED output signal.

B- AT RECEIVER

On the other hand , figure 7 shows the output when testing the implemented system at different pins of IC 7414 and MAX 232 IC to make sure of the circuit connection and operation as Fig. 7 (a) shows the received signal at photodiode , Fig. 7 (b) shows the output signal of 7414 IC pin 2. and Fig. 7 (c) shows the output signal of MAX 232 pin 14.

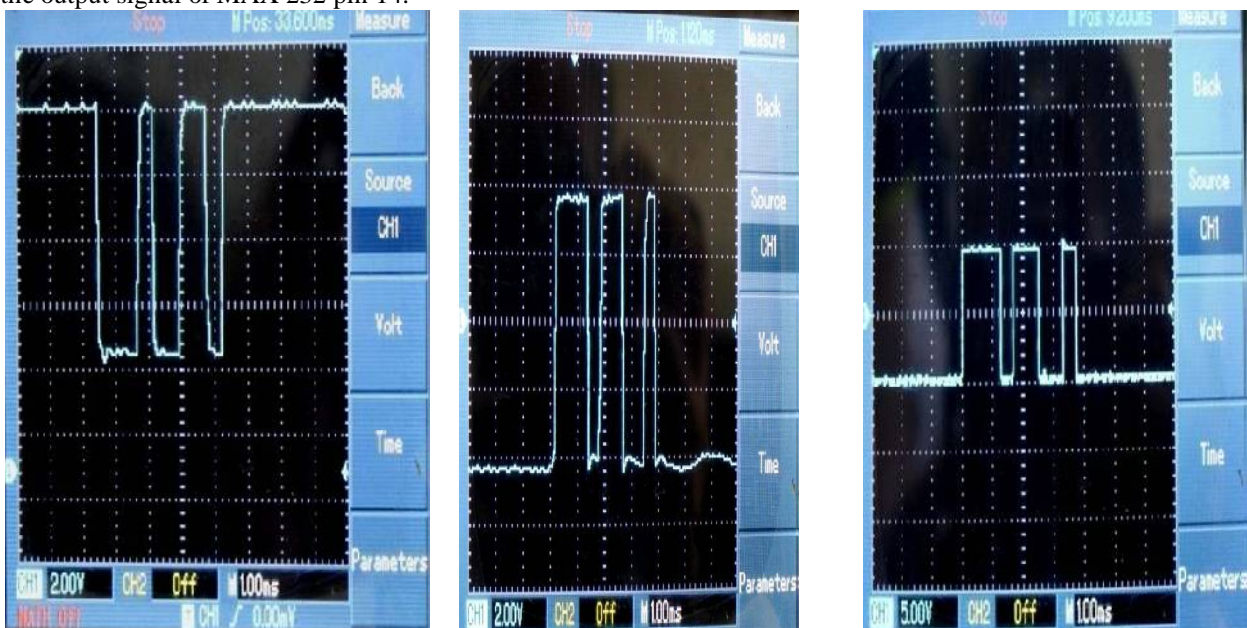

(a) (b) (c)

Fig. 7 Receiver Section Testing (a) photodiode signal (b) pin 2 of 7414 output signal (c) MAX 232 output signal.

C- SENDING AND RECEIVING DATA USING HYPER TERMINAL

- HyperTerminal (also known as HyperTerm) is a communications and terminal emulation program that comes with the Windows Operating System, beginning with Windows 98.
- HyperTerminal can be used to set up a dial-up connection to another computer through the internal modem using Telnet or to access a bulletin board service (BBS) in another computer. It can also be used to set up a connection for data transfer between two computers (such as your desktop computer and a portable computer) using the serial ports and for serial-port control of external devices or systems such as scientific instruments, robots, or radio communications stations. HyperTerminal can also be used as a troubleshooting tool when setting up and using a modem. You can send commands through HyperTerminal to make sure that your modem is connected properly.
- Here , we used it for data transmission through the serial ports as shown in fig. 8 , then connecting the implemented circuits (transmitter and receiver) to both computers through USB to RS 232 Cable and starting sending data from one to another and vice versa as shown in fig. 9.

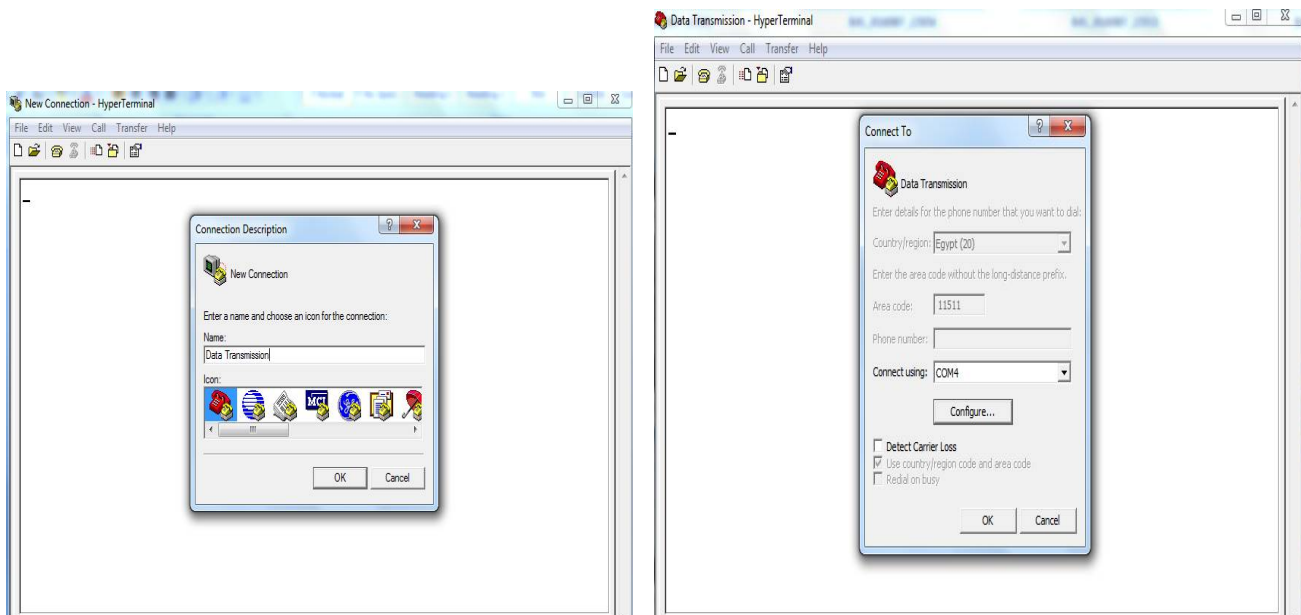

(a)

(b)

Fig. 8 shows the hyper terminal windows and its connection type (com 4) (a) Connection description window where we name the connection (b) window where we choose the connection type (i.e how to connect to the other computer ?).

International Journal of Innovative Research in Science, Engineering and Technology

(An ISO 3297: 2007 Certified Organization)

Vol. 5, Issue 9, September 2016

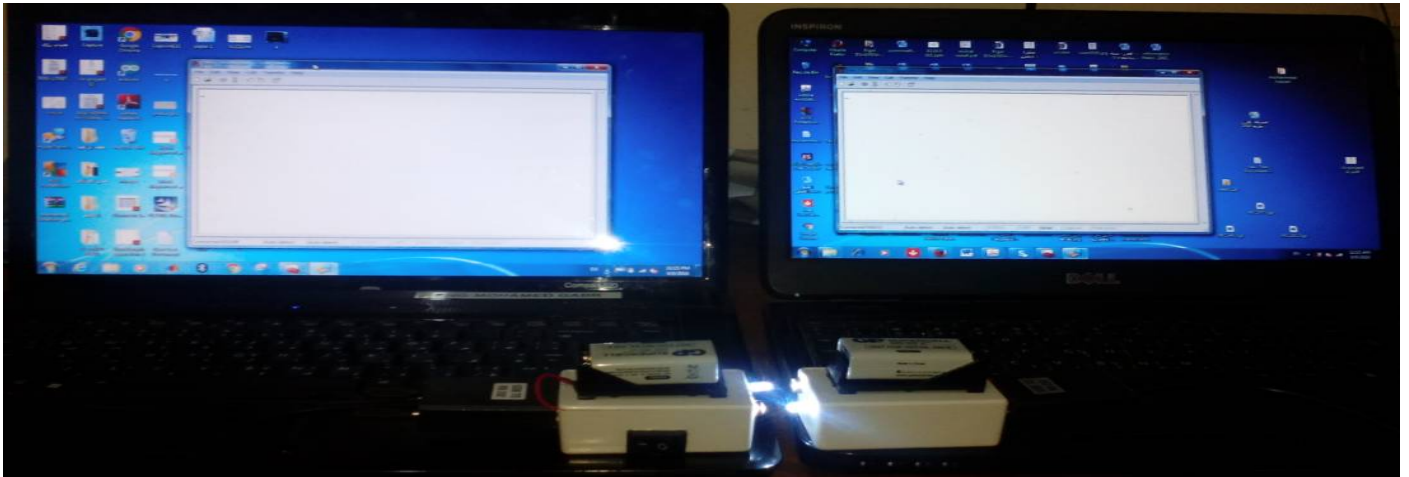

Fig. 9 shows how both computers are connected via VLC System , the hyper terminal program is launched in both computers as shown and the window which appears is used to enter the texts we want to send and then it appears in the other computer.

When we begin to send this text :

“ HELLO DATA TRANSMISSION via VISIBLE LIGHT COMMUNICATION TECHNIQUE USING HYPER TERMINAL UNDER DUPERVISION OF DR LOTFY RABEH , MOHAMED I. GABR AND TAREK HOSNY . .«.«.«.«. THANKS SO MUCH . .«.«.«. . ”, it appears simultaneously on the other computer screen (the receiver) as shown in figure 10.

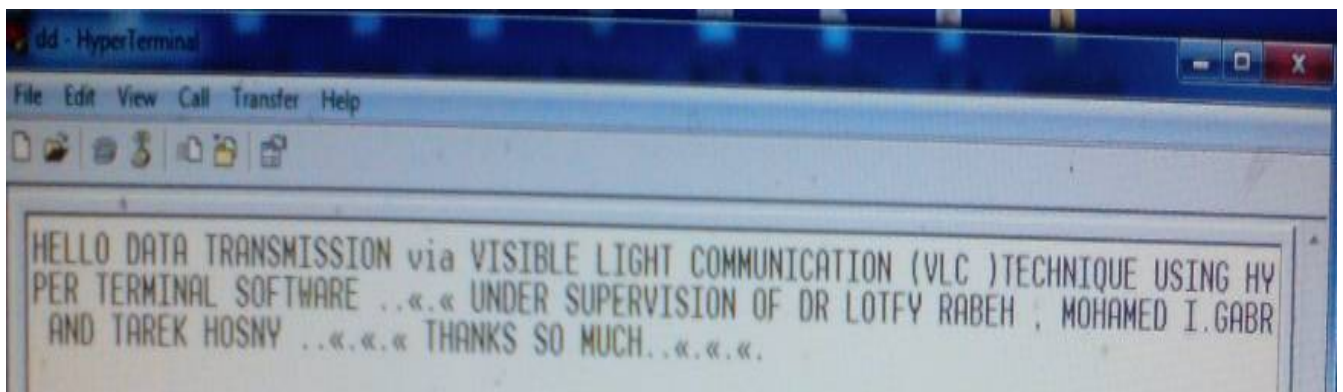

Fig. 10 , The message we want to send through VLC system from transmitter to receiver using Hyper terminal software installed in both computers.

V. CONCLUSION

Visible Light Communication (VLC) present fascinating challenges for using appropriate techniques to construct cheap processing units and high brightness LEDs. Where LEDs lighting technology is being considered as the next generation lighting devices, VLC using LEDs would be promising technology for ubiquitous communication. The technology promises a great mix of importance, from high energy saving using Solid State Lighting technology and high rate data transmission in indoor applications to traffic safety in outdoor environment. The optical wireless communication system is a very good replacement for the regular communication systems Visible Light Communication is a rapidly growing segment of the field of

International Journal of Innovative Research in Science, Engineering and Technology

(An ISO 3297: 2007 Certified Organization)

Vol. 5, Issue 9, September 2016

communication. There are many advantages to using VLC. There are also many challenges. VLC will be able to solve many of the problems people have been facing for many years, mainly environmental and power usage issues. We can be sure that the future for Li-Fi is bright. Li-Fi consortium believes it is possible to achieve more than 10Gbps, theoretically allowing a high definition film to be downloaded in 30 seconds.

VI. FUTURE WORK

In future, we wish to design and implement Optical Atto Cell via Visible Light Communication (VLC) Technique.

REFERENCES

- [1] Shaista Taranum, "Data Transmission Through Smart Illumination via "Visible Light Communication Technology" ", International Journal of Technical Research and Applications, Volume 4, Issue No. 2, PP. 136-141, (March-April, 2016).
- [2] Stanislav ZVANOVEC, Petr CHVOJKA, Paul Anthony HAIGH, Zabih GHASSEMLOOY, "Visible Light Communications towards 5G", RADIOENGINEERING, VOL. 24, NO. 1, APRIL 2015.
- [3] Dobroslav Tsonev, Stefan Videv and Harald Haas, "Towards a 100 Gb/s visible light wireless access network", Optical Society of America Vol. 23, No. 2, 26 Jan 2015.
- [4] U.SUGANYA1, C.SUBHALAKSHMIPRIYA, "Li - FI (Light Fidelity) Technology ", INTERNATIONAL JOURNAL OF RESEARCH IN COMPUTER APPLICATIONS AND ROBOTICS ", Vol.3 Issue No.1, PP. 26-32, January 2015.
- [5] K. Sindhubala and B. Vijayalakshmi, "Design and Implementation of Visible Light Communication System In Indoor Environment", ARPN Journal of Engineering and Applied Sciences ", VOL. 10, NO. 7, APRIL 2015.
- [6] Pokpoom Chanthosot , Vittaya Tipsuwanporn , Viriya Krongratana and Thanaporn Lilawatthanun, "The Indoor Use Development for Visible Light Communication", Proceedings of the World Congress on Engineering and Computer Science 2015 Vol I WCECS 2015, October 21-23, 2015, San Francisco, USA
- [7] Sathya.T , Prof.E.Divya , Prof.S.Raja, "Visible Light Communication for Wireless Data Transmission", International Journal of Innovative Research In Electrical, Electronics, Instrumentation and Control Engineering ", Vol. 2, Issue No. 2, February 2014.
- [8] Rahul R. Sharma, Akshay Sanganal, Sandhya Pati, "Implementation of A Simple Li-Fi Based System", International Journal of Computing and Technology, Volume 1, Issue No. 9, October 2014.
- [9] Abhishek Kurup, Vipin Tiwari, Selvanathiya, "Implementation and Demonstration of LI-FI Technology", International Journal of Research in Engineering and Technology, Volume: 03, Issue No. 03 , Mar-2014.
- [10] Megha Goyal, Dimple Sapuroo, Asha Bhagashra, "New Epoch of Wireless Communication: Light Fidelity", International Journal of Innovative Research in Computer and Communication Engineering, Vol. 1, Issue No. 2, April 2013.
- [11] Rajan Sagotra, Reena Aggarwal, "Visible Light Communication", International Journal of Computer Trends and Technology (IJCTT) , volume 4 , Issue No. 4 , April 2013.
- [12] M. Saadi1, L. Wattisuttikulkij , Y. Zhao , P. Sangwongngam, "Visible Light Communication: Opportunities, Challenges and Channel Models", International Journal of Electronics & Informatics , Vol. 2, No. 1, 2013.