

# Design of a Switched Reluctance Motor in Ansys Maxwell

Ashwin Raj<sup>1</sup>, Sreekanth P K<sup>2</sup>P.G. Student, Department of Electrical & Electronics Engineering, Sree Buddha College of Engineering, Pattoor,  
Alappuzha, Kerala, India<sup>1</sup>Assistant Professor, Department of Electrical & Electronics Engineering, Sree Buddha College of Engineering, Pattoor,  
Alappuzha, Kerala, India<sup>2</sup>

**ABSTRACT:** Switched reluctance motor is finding massive application in various fields due to its high performance when Combined together with the power electronics. Magnetfree and winding free nature of the rotor, attracts fame for Switched Reluctance Motor, the same reasons results in the reduction of cost and ease of construction. There are numerous software's available for the modelling of electrical machines such Matlab, Comsol, Motor solve, Ansys Maxwell etc. which also helps in the finite element analysis of the model. This paper shows modelling steps of a Switched Reluctance Motor in Ansys Maxwell 3D.

**KEYWORDS:** Switched Reluctance Motor, Ansys Maxwell.

## I. INTRODUCTION

Electric machines can be sorted into two categories on the basis of how they produce torque i.e. electromagnetically or by variable reluctance. Electromagnetically means motion is produced due to the interaction of two magnetic fields, generated by the stator and the other by the rotor which is mutually coupled to produce an electromagnetic torque tending to bring the fields into alignment. The vast majority of motors used today operate on this principle. Some examples include DC and induction motors. Some ways of generating these fields are by energizing windings, with permanent magnets, and through induced electrical currents.

The second category includes variable reluctance type. Motion is produced as a result of variable reluctance in the air gap between stator and rotor. When a stator winding is energized, producing a single magnetic field, reluctance torque is produced because rotor tries to move to its minimum reluctance position similar to how a permanent magnet attracts iron or steel, where reluctance is minimized when the magnet and metal come into physical contact. The Switched Reluctance Motor (SRM) as they operate in this principle falls into this category of machines.

The SRM is the simplest of all electrical machines from the construction point of view because only the stator has windings. The rotor contains no conductors as windings or permanent magnets. It consists simply of steel laminations stacked onto a shaft. Due to this simple mechanical construction, the SRM cost low. This is the main reason that motivated a lot of researches to be carried on SRMs for finding its use in various applications. The Switched Reluctance Motors when accompanied with power electronics its performance can be varied and it can be made useful for various application where conventional AC and DC machines play prior role.

A number of machine modelling software's such as Matlab, Comsol, Motor Solve, Ansys Maxwell etc. are available. In this paper modelling steps for Switched Reluctance Motor using AnsysMaxwell 3D is presented. Ansys Maxwell is a high-performance user friendly software that uses Finite Element Analysis (FEA) to solve 3D magnetostatic and transient problems for machines modelled in them.

Paper is organized as follows. Section II describes 3DModelling of an SRM in Ansys Maxwell 3D using the user designed primitives. It showsthe steps to be followed for modelling in Ansys Maxwell.Section III shows the result obtained from the simulation of the model, which is shown as example.

# International Journal of Innovative Research in Science, Engineering and Technology

(An ISO 3297: 2007 Certified Organization)

Website: [www.ijirset.com](http://www.ijirset.com)

Vol. 6, Issue 2, February 2017

## II. RELATED WORK

Switched Reluctance Motor is one of the simplest machine from the construction point of view and due to that it is also one of the simplest machine to model in Ansys Maxwell. A model for an SRM with 8 stator poles and 6 rotor poles will be presented in this paper.

Steps for design of an SRM in Ansys Maxwell using user defined primitives is as follows.

1. Design the machine and find out the parameter for producing the required output.
2. Launch Ansys Maxwell software.
3. Open a New Project.
4. Set Solution Type as follows  
Maxwell > Solution Type, then Choose Transient and click the OK button.
5. Click on Maxwell 3D design symbol.
6. Create rotor using steps as below  
Draw > User defined primitive > RM exprt > SRM core.
7. The SRM core obtained after entering the parameters of the rotor of SRM will be the rotor as shown below

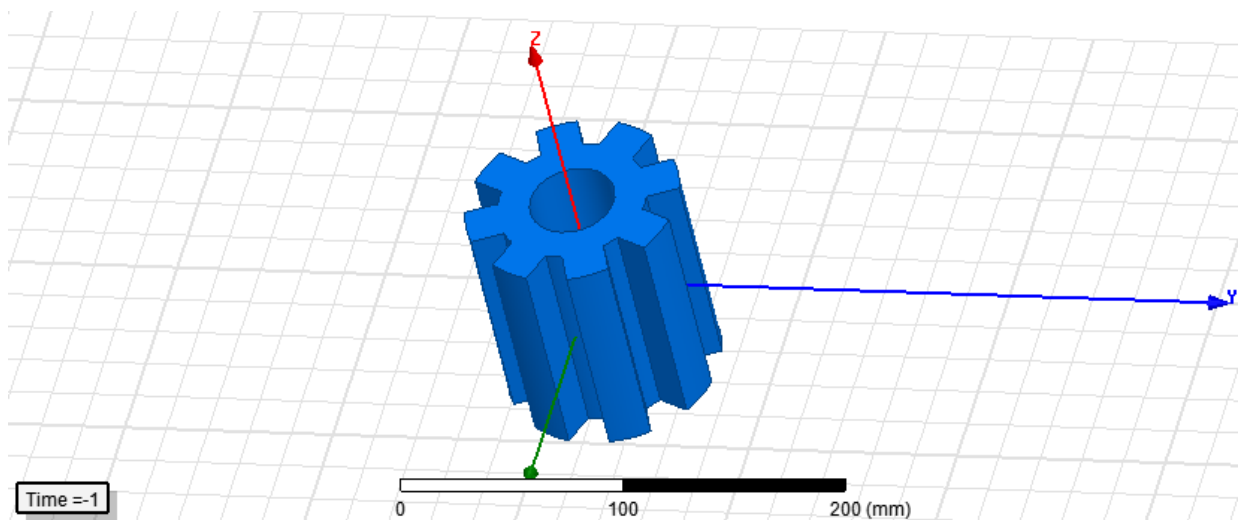

Fig. 1. Rotor Structure in Ansys Maxwell

Fig. 1. Shows the user defined rotor structure in Ansys Maxwell. The parameters for the rotor is obtained using machine design equations. It consists of 8 poles. The 3D view of the rotor in Ansys Maxwell as shown in the figure will be obtained if the above-mentioned steps are followed.

8. Follow the same as mentioned in step 6 and enter the parameters of the stator and the obtained part will be the stator of the SRM.
9. Ungroup the Stator and Coils  
Select Stator > Edit > Boolean > Separate Bodies
10. Process the Coils by selecting the coils Stator\_2, Stator\_3, Stator\_4, Stator\_5, Stator\_6 and delete them.  
Now the model has only one coil i.e. Stator\_1
11. Create terminals using coil Stator\_1. Select coil Stator\_1 and follow the steps  
Stator\_1 > Edit > Surface > Section
12. Assign Excitation to coils  
Select the item > Excitations > Assign > Coil Terminals
13. Duplicate by selecting the coils and coil terminals along Z-axis after assigning excitation.

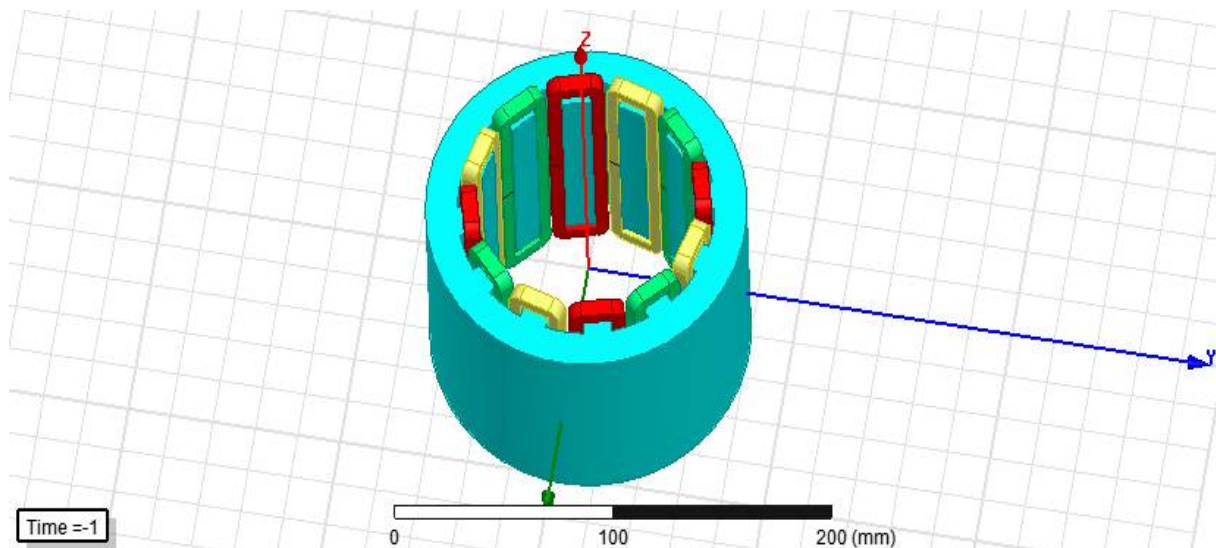

Fig. 2. SRM Stator structure in Ansys Maxwell

Fig. 2 shows the stator structure in Ansys Maxwell. It consists of 12 poles, for which 3phases are given for excitation. Excitation in SRM stator produce a variable reluctance which results for its operation to occur.

14. Add windings and assign the terminals to the windings.

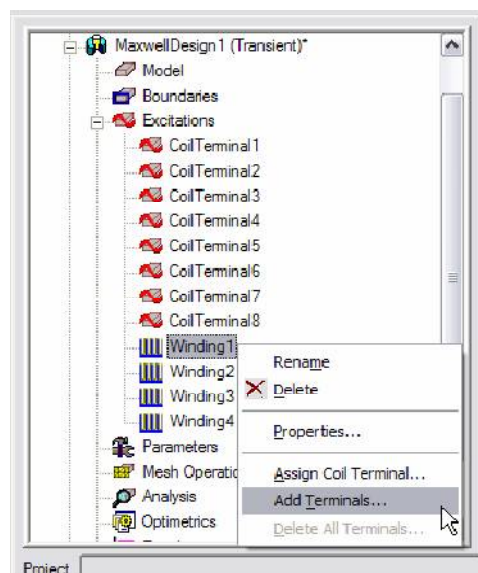

Fig. 3. Maxwell Project Manager tab for excitation of the coil

Fig. 3. shows the project manager tab in Ansys Maxwell. This figure shows how windings are given for excitation. It also shows how terminal are added to the windings for excitation to occur properly.

15. The next step is to create a band usually a cylinder which encloses the parts of the machine which rotates and assign it as band by right clicking then create a region which encloses the whole machine.

16. The last and final step is to create an analysis setup for the machine.

# International Journal of Innovative Research in Science, Engineering and Technology

(An ISO 3297: 2007 Certified Organization)

Website: [www.ijirset.com](http://www.ijirset.com)

Vol. 6, Issue 2, February 2017

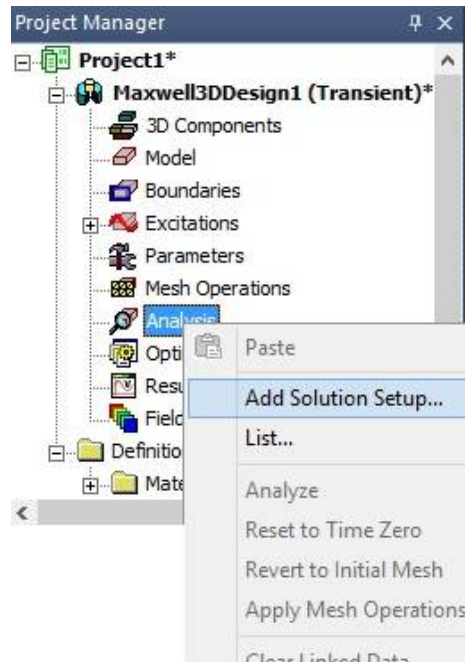

Fig. 4. Maxwell Project Manager Tab for adding solution setup

Fig. 4. Shows the project manager tab in Ansys Maxwell. This figure shows how to add a solution set up for the designed model. You can give the rated values for which the machine is designed for.

The SRM model after following the above-mentioned steps will be as follows

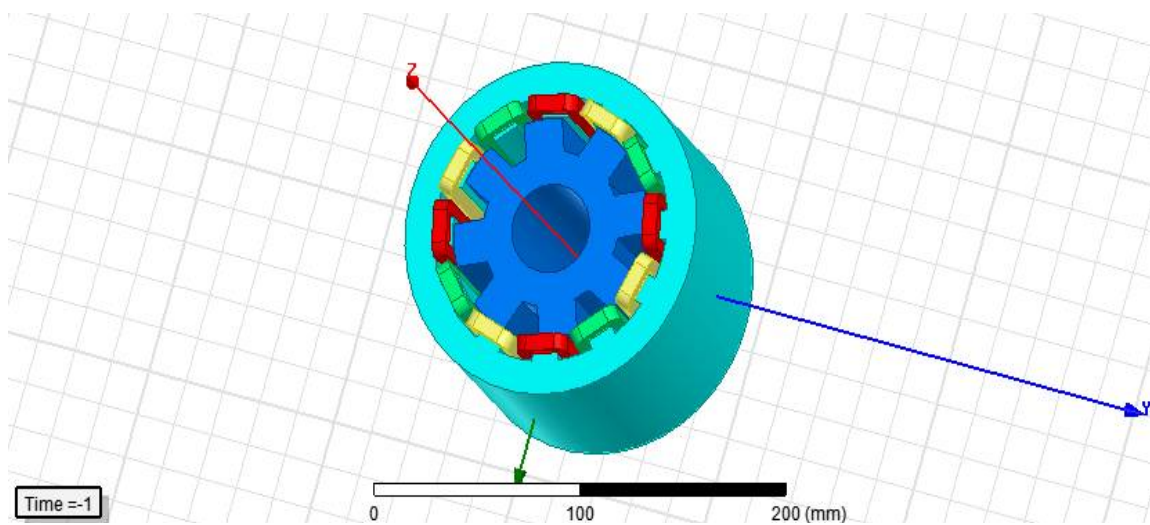

Fig. 5. 3D model of SRM in Ansys Maxwell

Fig. 5. shows the complete model of the designed model in Ansys Maxwell. This is the 3D view of the SRM with 12 stator poles and 8 rotor poles

### III. EXPERIMENTAL RESULTS

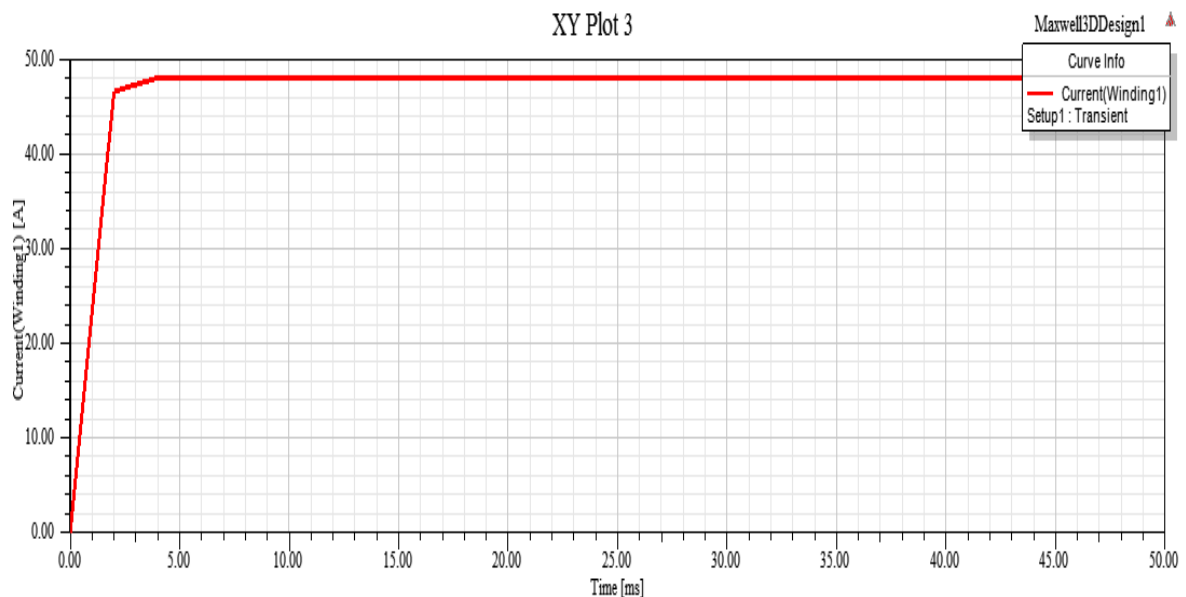

Fig. 8. Winding Current Vs Time graph 12/8 SRM

The 3phase winding current of the Switched reluctance motor is shown in the Fig.8. It shows that winding current converges to around 48A for the designed motor and remains steady for the operation of the motor after a time of 4ms.

### IV. CONCLUSION

The paper shows the designing of Switched Reluctance Motor in Ansys Maxwell 3D. A switched reluctance motor with 12 stator poles and 8 rotor poles is designed in Maxwell and the current in windings is shown which shows that the value converges to 48A. If the machines are used in addition to power electronics, its operating region can be varied to make it useful for various kinds of application.

### REFERENCES

- [1] R. Krishnan, Switched reluctance motor drives: modeling, simulation, analysis, design, and applications: CRC press, 2001.
- [2] T.J.E. Miller, Switched reluctance motors and their control, Oxford, Magna, 1993.
- [3] P.J. Lawrenson, J.M. Stephenson, P.T. Blenkinsop, J.Corda, N.N. Fulton Variable Speed Switched ReluctanceMotors, IEEE PROC, Vol. 127, Pt. B, No. 4, 1980
- [4] P.J. Lawrenson, J.M. Stephenson, P.T. Blenkinsop, J.Corda, N.N. Fulton Variable Speed Switched ReluctanceMotors, IEEE PROC, Vol. 127, Pt. B, No. 4, 1980.
- [5] Hannoun, H., M. Hilairat, C. Marchand. "Analytical modeling of switched reluctance machines including saturation." in Proc. 2007 IEEE International Electric Machines & Drives Conference, vol.1, no., (May 2007). pp.564-568
- [6] Krishnan, R., R. Arumugan, J. F. Lindsay. "Design procedure for switched-reluctance motors." IEEE Transactions on Industry Applications, vol.24, no.3, (May/Jun 1988). pp.456-461
- [7] Venkataratnam, K. Special electrical machines. Hyderabad, India: Universities Press, 2009. Print
- [8] Chapman, Stephen J. Electric Machinery and Power System Fundamentals. Boston: McGraw-Hill, 2002. Print.
- [9] Radun, Arthur V. "Design considerations for the switched reluctance motor." IEEE Transactions on Industry Applications, vol.31, no.5, (Sep/Oct 1995). pp.1079-1087.
- [10] Husain, Iqbal. Electric and hybrid vehicles: design fundamentals. Boca Raton, Fla.: CRC Press, 2003. Print.
- [11] Kwon, Y.A. "Computation of Optimal Excitation of a Switched Reluctance Motor Using Variable Voltage." IEEE Transactions on Power Electronics, vol. 45, No. 1, (February 1998). pp.177-180.
- [12] Acamley, P. P. Stepping Motors: A Guide to Theory and Practice. 4th ed. London: Institution of Electrical Engineers, 2002. Print.