

# **Controlling and Monitoring of Power Supply from Substation using GSM Modem**

A.Poonguzhali<sup>1</sup>, Sushmitha B.R.<sup>2</sup>, Swati Nagaraj Mesta<sup>3</sup>

Assistant Professor, Department of Electronics and Communication Engineering, Sri Sairam College of Engineering,  
Bengaluru, Karnataka, India<sup>1</sup>

U G Student, Department of Electronics and Communication Engineering, Sri Sairam College of Engineering,  
Bengaluru, Karnataka, India<sup>2</sup>

U G Student, Department of Electronics and Communication Engineering, Sri Sairam College of Engineering,  
Bengaluru, Karnataka, India<sup>3</sup>

**ABSTRACT:** Nowadays it has become very much complex in maintaining the substations (power stations) , mainly the power stations with in the domestic purpose and the utility company , since the large amount of power is transmitted from the main stations to the substation it is more important to monitor the quality proportion of the power from generated and the received power at the substations ,it is also in need of controlling the flow through the advanced technology i.e. Through GSM modem the message would be sent to the domestic usage and the main station as well therefore we have used a circuit for the check of current flow , to analyze the voltage flow ,with a relay for switching, a microcontroller. This in term reduces the labor cost and less human intervention.

**KEYWORDS:** transformers, microcontroller (PIC16F877A), GSM module, substation.

## **I. INTRODUCTION**

A domestic power supply is the one where most of the connections are held or terminated to the houses and the small scale industries mainly the utility company. Since the power that is generated from the main station is transmitted through the long distance to the substation and hence which will lower the quality and quantity of the power that is received.

The proposed design is developed for the user to easily recognize the transformer is safe or unsafe. The project is a device used for measurement of transformer parameters through wireless system, which has inbuilt step-down transformer with voltage , frequency and measurement circuit for measuring input voltage and frequency of a transformer, on other hand to monitor the fault such as overvoltage and under voltage. If any of these does occur then a message will be sent to the design controlling unit or substation.

The proposed design is developed for the user to easily recognize the transformer is safe or unsafe. The project is a device used for measurement of transformer parameters through wireless system, which has inbuilt step-down transformer with voltage , frequency and measurement circuit for measuring input voltage and frequency of a transformer, on other hand to monitor thefault such as overvoltage and under voltage. If any of these does occur then a message will be sent to the design controlling unit or substation.

Working of this module has fallows, initially 230 v ac input voltage from mains supply in stepped down 12v ac through 12-0-12 step-down transformer and then its output given to frequency, voltage measurement circuit and at end these measurement data is feed to microcontroller forprocessing information.

# International Journal of Innovative Research in Science, Engineering and Technology

(An ISO 3297: 2007 Certified Organization)

Vol. 6, Special Issue 12, July 2017

## II. SYSTEM ANALYSIS

### 2.1 Existing system:

At present till now measurement of some important parameter of transformer read through certain display meters manually.

2.2 Proposed system: (a) At this project design, structured modular design concept is adopted and the system is mainly composed of a single micro controller, Auto transformer, voltage circuit, short circuit, current transformer, relay and GSM.

- (b) The microcontroller located at the center of the block diagram forms the control unit of the entire project .
- (c) Embedded within the micro controller is a program that helps the micro controller to take the action based on the inputs provided by the output of the sensors.
- (d) In this demonstration, auto transformers are used to detect low voltage. The output of the auto transformer is given to a voltage circuit . The output of the voltage circuit is connected to the i/o pins of the micro controller which is connected to the ADC present on- chip.
- (e) If the voltage is below some voltage level, then the message will be displayed on the LCD.
- (f) On the other hand, if overload condition is detected, through the voltage circuit connected to the current transformer (CT), SMS alert is sent through the GSM.
- (g) The bulb can be turned off through the of GSM via SMS alert is sent through the GSM here to show overload condition bulb of high voltage rating i.e 100W is used, where as normal voltage is shown by connecting bulb of 40W and 60W.
- (h) The LCD is utilized to demonstrate the working of the entire unit.

## III. DESIGN

The design of the proposed system consists of

1. Single micro controller

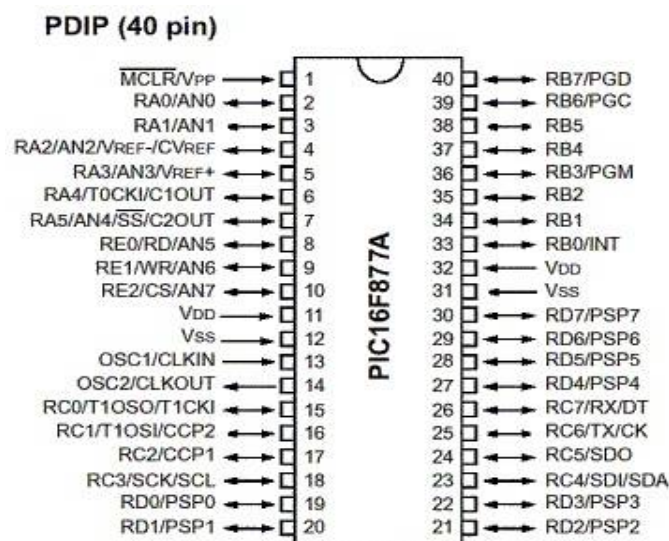

# International Journal of Innovative Research in Science, Engineering and Technology

(An ISO 3297: 2007 Certified Organization)

Vol. 6, Special Issue 12, July 2017

## 2. Auto transformer

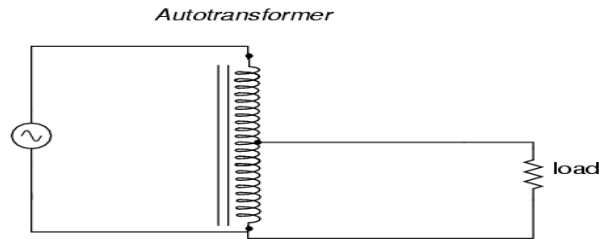

## IV. REQUIREMENTS SPECIFICATIONS

### 1. Hardware specification

Block diagram of proposed system

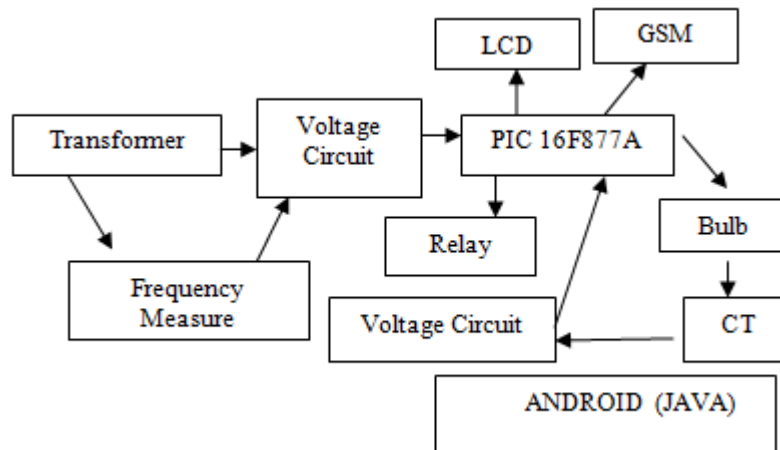

### 2. Software specification

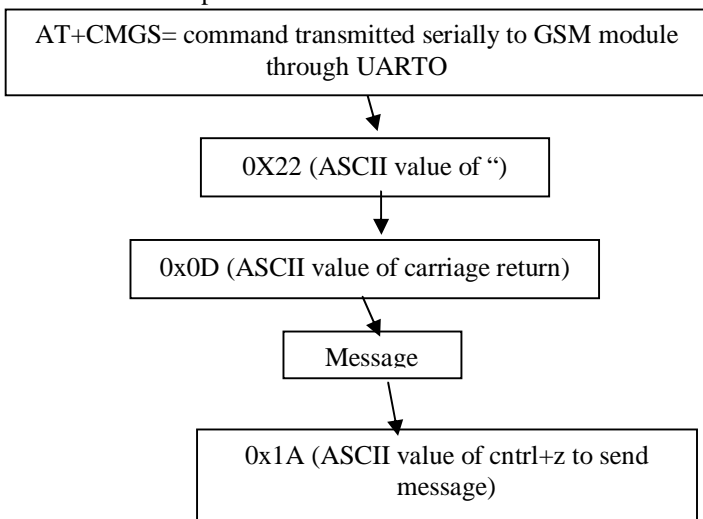

# International Journal of Innovative Research in Science, Engineering and Technology

(An ISO 3297: 2007 Certified Organization)

Vol. 6, Special Issue 12, July 2017

## FEASIBILITY STUDY

Technically feasible:

The project is technically feasible; it can be implemented conveniently after carefully examining the requirements.

Feasible within the estimated cost:

The project is economically feasible; the data acquisition is faster reducing the cost and increasing the efficiency of the system.

LCDFLOW CHART:

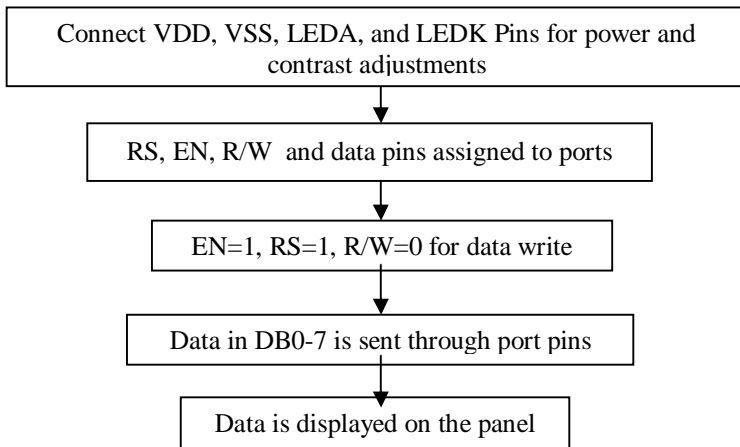

1.

Economical

## ADVANTAGES:

1. Economical
2. Wide range of control
3. Reliable power supply
4. Increase of power equipment life
5. Less staff required
6. Data access around the globe.

## ANALOG TO DIGITAL CONVERSIONFLOW CHART

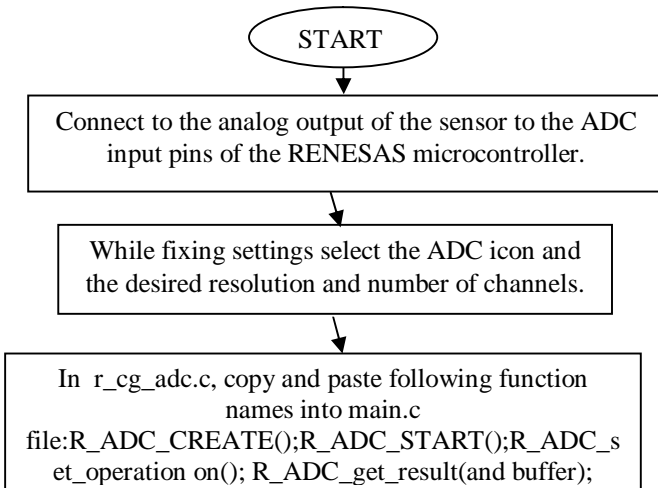

## International Journal of Innovative Research in Science, Engineering and Technology

(An ISO 3297: 2007 Certified Organization)

Vol. 6, Special Issue 12, July 2017

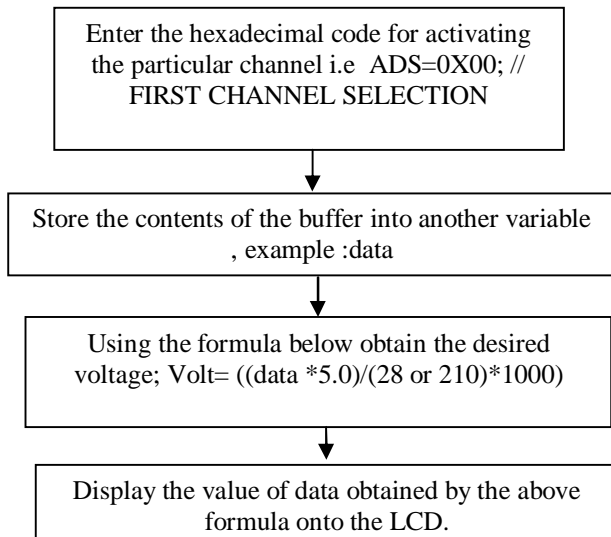

Flow chart for port assignment and LCD display

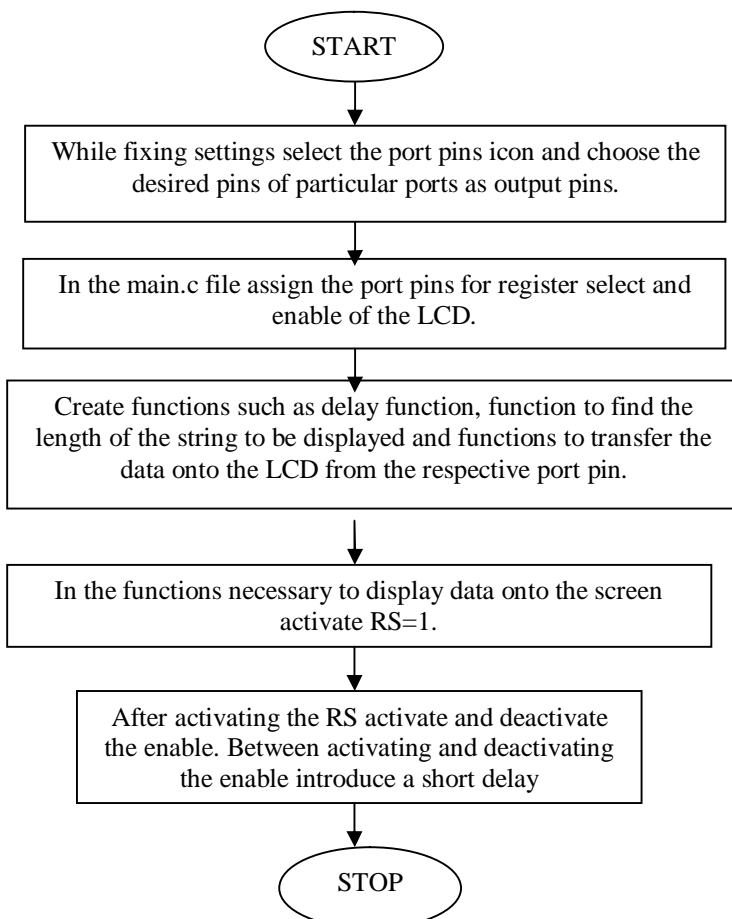

# International Journal of Innovative Research in Science, Engineering and Technology

(An ISO 3297: 2007 Certified Organization)

Vol. 6, Special Issue 12, July 2017

## V. RESULTS

Electrical parameters like current, voltage is composed continuously to its rated value and helped protecting the distribution and power transform from burning due to overload, short circuit fault, overvoltage and surges. Under these conditions, entire unit is shut down via the control section comprising of relays sensing it, and immediately turning the circuit breaker off. SMS alerts are generated to indicate this. The usage of GSM makes the substation intellectual in the sense that it is able to convey alerts, information and accept instructions. This is enabled to reduce labour cost at substation and save time. Thus the monitoring and working efficiency of the substation has drastically increased.

## VI. CONCLUSION

The designed system is a step towards smart grid. It basically resembles plc (power line communication) that is used as a communication platform for today's the smart grid networks around the world. Under these conditions, entire unit is shut down via the control section comprising of relays sensing it, and immediately turning the circuit breaker off. SMS alerts are generated to indicate this. The usage of GSM makes the substation intellectual in the sense that it is able to convey alerts, information and accept instructions. This is enabled to reduce labour cost at substation and save time.

## REFERENCES

- [1] "PICMicrocontrollers", [www.microchip.com/pagehandler/en-us/products/picmicrocontrollers](http://www.microchip.com/pagehandler/en-us/products/picmicrocontrollers)
- [2] "PIC-16F87XA] datasheet", [www.microchip.com/downloads/en/DeviceDoc/39582C.pdf](http://www.microchip.com/downloads/en/DeviceDoc/39582C.pdf)
- [ 3 ] "Sim908" <http://wm.sim.com/producten.aspx?id=1024>
- [4] <https://www.quora.com/What-exactly-is-the-single-phase-current-that-we-get-in-our-homes>