

Investigation of the Mechanical Properties of AISI 304 Austenitic Stainless Steel Joints Produced by TIG and MIG Welding Methods using 308L Filler Wire

Bahadır Işcan¹, Volkan Onar², Arzum Uluköy^{3,*}

B.S. Student, Department of Manufacturing Engineering, Pamukkale University, Denizli, Turkey¹

Research Assistant, Department of Manufacturing Engineering, Pamukkale University, Denizli, Turkey²

Assistant Professor, Department of Manufacturing Engineering, Pamukkale University, Denizli, Turkey³

ABSTRACT: In this study, AISI 304 stainless steel samples having 2 mm thickness were joined in butt welding using TIG and MIG methods. 308L filler wire was used for the joints, and 70 A, 90 A, and 110 A were selected as welding currents. Macro and micro-structural analyses were carried out via metal and optical microscopes. Tensile tests were carried out for determining yielding and tensile strengths, also. Experimental results showed that, except for the samples welded by 110 A welding current, the fracture were not occurred in the welding zone. It can be concluded that brittleness of welded area was increased by increasing welding current due to the formation of undesired precipitates.

KEYWORDS: AISI 304, 308L Filler Wire, Mechanical Properties, Heat Input, Welding Current.

I. INTRODUCTION

Steels containing at least 10.5% chromium are called stainless steel. Thin but dense chromium oxide layer formed on the surface of stainless steel provides high resistance to corrosion, and proceeding of oxidation towards the interior of the steel is prevented by this layer. Basically, there are five types of stainless steel depending on the other additive elements they contain [1,2]:

- a) Austenitic
- b) Ferritic
- c) Martensitic
- d) Dual Phase (duplex)
- e) Precipitation-hardening

AISI 300 austenitic stainless steels constitute approximately 60% of the world total stainless steel production. They contain a maximum of 0.15% carbon, a minimum of 16% chromium, and sufficient amount of nickel and/or manganese to stabilize the austenitic structure between very low temperatures and the melting temperature. Austenitic stainless steels have not magnetic properties. However, they cannot be hardened by heat treating, but can be hardened by cold deformation. They have excellent corrosion resistance and good formability. They can also be combined very easily with welding [1,2]. These alloys have high toughness and high strength values in a wide range of temperatures, and show resistance to oxidation up to 540 °C. Austenitic stainless steels contain 16-26% Cr, 10-24% Ni + Mn, up to 0.40% C, and other alloying elements in low amounts, such as Mo, Ti, Nb, and Ta. The balance between the Cr and Ni + Mn ratios was established in such a way that a microstructure consisting of 90-100% of austenite to be obtained.

The most well-known AISI 300 series' type is AISI 304 (X5CrNi18-10), which contains 18% chromium and 8% nickel. This stainless steel is the most preferred stainless steel because of its good mechanical properties, weldability, formability, and very good corrosion-oxidation resistance. Having its superior properties, they are used in many

International Journal of Innovative Research in Science, Engineering and Technology

(An ISO 3297: 2007 Certified Organization)

Vol. 6, Special Issue 10, May 2017

different application areas, such as roofing and architectural paneling, railings, food processing equipment, kitchen benches/ sinks/troughs equipment and appliances, chemical containers, heat exchangers, threaded fasteners, springs, welded screens for mining [1-3]. Many of these parts are joined using welding process. Despite the high weldability of AISI 304 stainless steel, there are three main problems in the welding of austenitic stainless steels [4-11];

- 1) Formation of chromium carbide (CrC) in the heat-affected zone,
- 2) Formation of hot cracks on welded area,
- 3) Formation of sigma phase at high operating temperatures

The type and shape of the filler metal to be used, the welding method, heat input, the dimensions of the welded joint, and the number of welded parts play an important role of welding quality of these steels. Cooling rate, microstructure, and mechanical properties of the heat-affected zone can be affected by heat input [3-7]. Low welding speed, long welding time, and high welding current result occurring of high heat input. Increasing heat input can cause enlarged weld bead, undesired formations, and undesired problems. Kumar et.al [5] investigated the effect of three different heat input values on the microstructure and mechanical properties of the welded 304 stainless steel joints. As the heat input decreased, they found that the tensile strength of the welded joint increased.

In this study, two different welding methods and three different welding current values were used in joining of 304 austenitic stainless steels. Heat input effects on the mechanical properties were investigated.

II. MATERIAL AND METHOD

AISI 304L stainless steel samples having 2 mm thickness were combined in butt position using TIG and MIG welding methods. Three separate welding currents were used in the joints as 70, 90, and 110 Amperes. As shown in Fig. 1 and Fig. 2, three samples were prepared for each method and for each welding current. Chemical composition and mechanical properties of AISI 304L stainless steel are shown at Table 1 and Table 2.

308L welding wire which is preferred for TIG welding of Cr-Ni steels with high corrosion resistance were used for joining. This welding wire is used generally the food, beverage, and pharmaceutical industries for manufacturing of stainless steel equipment, tanks and pipe joining. The chemical composition and mechanical properties of the welding wire can be shown at Table 3 and Table 4. After the welding operation, tensile specimens were obtained by cutting in water-jet according to the standards to be 20x200x2 mm. The samples were subjected to a tensile test at a speed of 20 mm/s using a 30 tons capacity tensile test machine. Three tensile test samples were prepared for each condition.

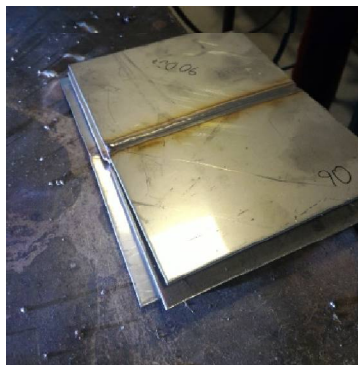

Fig. 1. Welded joints

International Journal of Innovative Research in Science, Engineering and Technology

(An ISO 3297: 2007 Certified Organization)

Vol. 6, Special Issue 10, May 2017

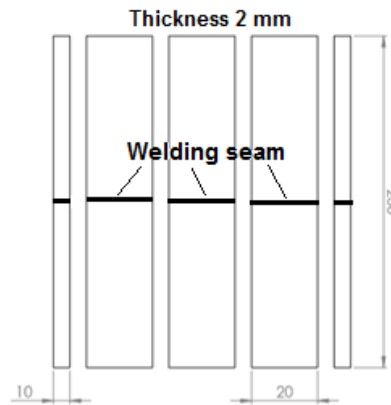

Fig. 2. Dimensions of welded samples

Table 1. The chemical composition of AISI 304 L stainless steel [1]

| %C | %Mn | %P | %S | %Si | %Cr | %Ni |
|-------------|-------------|-------------|-------------|----------|-----------|------|
| 0.08 max | %2.0 max | 0.04 max | 0.03 max | 1 max | 18- 20 | 8-10 |

Table 2. Mechanical properties of AISI 304 L stainless steel [1]

| | |
|--------------------------|---------------|
| Tensile Strength (MPa) | 515 - 720 MPa |
| Yield Point, (%0,2)(MPa) | 205 MPa (min) |
| Hardness, Brinel (HB) | 201(max) |

Table 3. The chemical composition of 308L welding wire [12]

| %C | %Mn | %Si | %Cr | %Ni |
|--------|----------|-----------|--------------|------|
| in wt. | | | | |
| < 0.03 | 1,0 -2,5 | 0,30-0,65 | 19,50 -22,00 | 9-11 |

Table 4. The mechanical properties of 308L welding wire [12]

| | |
|--|-----|
| Yield Point, (N/mm ² , MPa) | 380 |
| Rupture Strength (N/mm ² , MPa) | 570 |
| Impact resistance (J) | 100 |
| Elongation (%) | 40 |

Macro microstructure images were visualized with a stereo microscope. Microstructure analyzes were performed after application of grinding, polishing, and etching processes. Microhardness measurements were made by taking 3 measurements per point along the weld seam to obtain micro hardness distribution, also.

III. RESULTS AND DISCUSSION

A) TENSILE TESTING RESULTS

As a result of the tensile test, yield strength, tensile strength, and elongation values were obtained. The obtained results which were average value of three samples can be seen at *Table 5*.

International Journal of Innovative Research in Science, Engineering and Technology

(An ISO 3297: 2007 Certified Organization)

Vol. 6, Special Issue 10, May 2017

Table 5. Tensile test results

| Welding Current, A | Welding method | Rm, MPa | Re, MPa | A, (%) |
|--------------------|----------------|---------|---------|--------|
| 70 | TIG | 641 | 327 | 27 |
| 90 | | 560 | 290 | 24 |
| 110 | | 470 | 252 | 16 |
| 70 | MIG | 623 | 328 | 42,5 |
| 90 | | 540 | 284 | 45 |
| 110 | | 486 | 255 | 42 |

As a result of tensile tests (*Table 5*), approximately the same yield strength and tensile strength values were obtained for both methods. However, the elongation values obtained by the MIG method were higher than the elongation values obtained by the TIG method. As the current values were increased, the strength values were decreased. The highest values were obtained by welding current of 70 A which was the lowest current value, in both welding methods. In the welded structures joined by the TIG method, the elongation values showed a significant decreasing as the welding current value increased. In the MIG welded structure, there was not observed that change in elongation.

It was determined that the breaks were formed on the main material except for 110 A welding current. 110 A welding current were resulted breaks in the welded area. It can be said that high heat input values caused this situation. The brittleness of welded area was increased by increasing welding current due to the formation of undesired precipitates. In *Fig. 3*, it can be seen that that the samples before the test and after the test.



Fig. 3. Tensile test sample images (a) before the tensile test (b) after the tensile test

B) MACRO STRUCTURE RESULTS

Macrostructure analyzes indicate that as the welding current is increased, a large amount of distortions in weld seam by TIG method were formed (*Fig. 4*). The same situation was not occurred in the MIG method (*Fig. 5*).

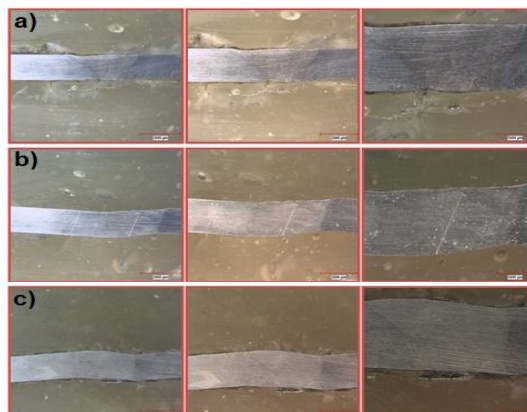

Fig. 4. Macro structures of TIG welded samples (a) 70 A, (b) 90 A, (c) 110 A

International Journal of Innovative Research in Science, Engineering and Technology

(An ISO 3297: 2007 Certified Organization)

Vol. 6, Special Issue 10, May 2017

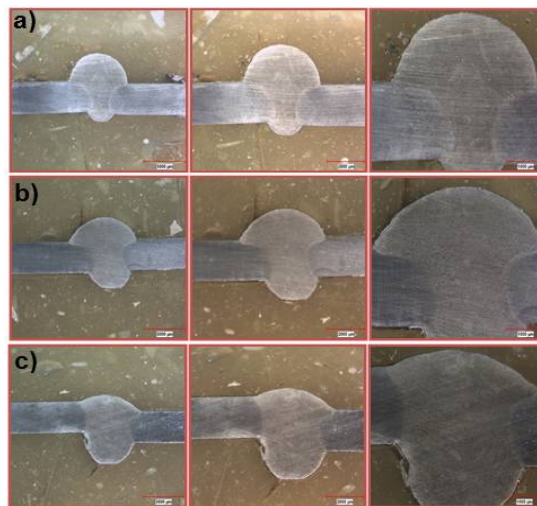

Fig. 5. Macro structures of MIG welded samples (a) 70 A, (b) 90 A, (c) 110 A

C) MICROSTRUCTURE RESULTS

After the water jet cutting, the samples taken from the pieces were examined with a microscope and microstructural images of the surfaces were taken. When the microstructures of the joints obtained by TIG welding were investigated, it was determined that the grains formed at the welding center to be a dendritic structure (Fig. 6). In the transition zones it was found that the grains were oriented towards the welding center and the dendritic structure grown as the welding current increased. The obtained results are consistent with the literature [5].

In MIG welding method, it was observed that the grains were directed toward the welding center from transition zones, and this orientation turned into a dendritic structure at the welding center (Fig. 7). Transition zone and welding zone grain structure and distribution were obtained more regularly in the MIG source than in the TIG source. The obtained results are consistent with the literature [5].

It is known that the risk of CrC precipitation on the stainless steels' welding seam due to the increase of heat input at a high welding current. The highest welding current value in this study, 110 A, has the highest heat input than the 90 A and 70 A. When the 90 A welding current was used, CrC precipitation appeared to be somewhere. When 70 A was selected welding current due to its low heat input effect, it was not observed any CrC precipitation in the welding area.

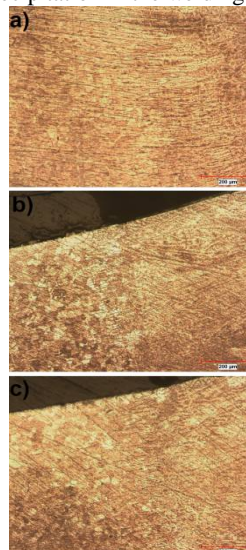

Fig. 6. Transition zone microstructures of TIG welded samples (a) 70 A, (b) 90 A, (c) 110 A

International Journal of Innovative Research in Science, Engineering and Technology

(An ISO 3297: 2007 Certified Organization)

Vol. 6, Special Issue 10, May 2017

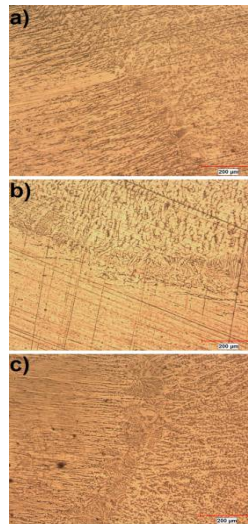

Fig. 7. Transition zone microstructures of MIG welded samples (a) 70 A, (b) 90 A, (c) 110 A

D) MICROHARDNESS RESULTS

For samples welded by TIG method, the lowest hardness values and the most uniform hardness distributions than the MIG welded joints were obtained (Fig. 8 and Fig. 9). The lowest hardness value was obtained as approximately 226 HV using 70 A. The main material's hardness was determined as to be 180 HV. As the welding current value increased, the maximum hardness values also increased from 230 HV to 250 HV using TIG welding method.

The lowest hardness value was obtained as approximately 231 HV using MIG welding at 70 A. The main material's hardness was determined as to be 180 HV. As the welding current value increased, the maximum hardness values also increased from 231 HV to 260 HV using MIG welding method, and the hardness transition was sharpened, too.

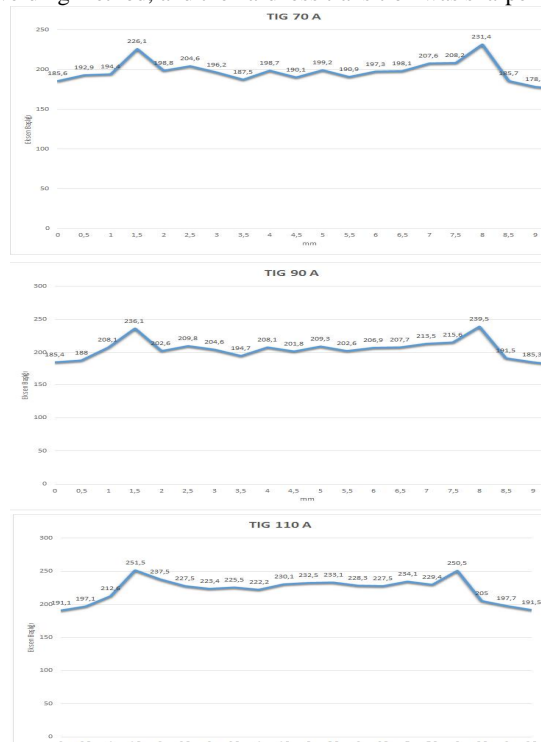

Fig. 8. Microhardness distribution of TIG welded samples

International Journal of Innovative Research in Science, Engineering and Technology

(An ISO 3297: 2007 Certified Organization)

Vol. 6, Special Issue 10, May 2017

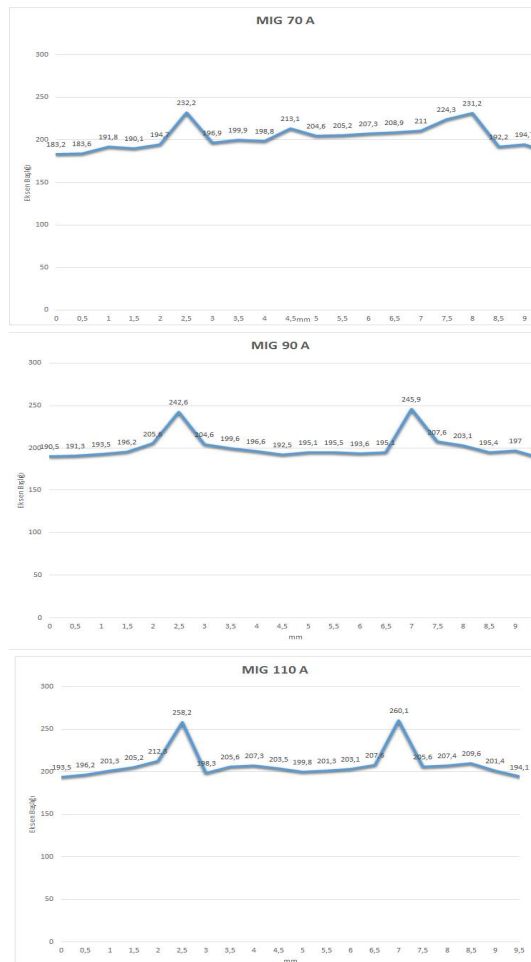

Fig. 9. Microhardness distribution of MIG welded samples

IV. CONCLUSION

In this study, TIG and MIG welding methods were used as joining of AISI 304 austenitic stainless steels. Three different welding currents were selected as 70, 90 and 110 Amperes for welding currents. Macro and microstructural analysis, hardness distribution analysis, and mechanical properties were determined. As a result of this study, it can be concluded that;

- 1) The 110 A welding current were caused by breaks on the welded area at the tensile tests due to excessive heat input effect.
- 2) The maximum tensile strength at joints made by MIG welding method was obtained as 623 MPa at 70 A, 540 MPa at 90 A, and 486 MPa at 110 A. For the joints made by the TIG welding method, the maximum tensile strength was obtained as 641 MPa at 70 A, 560 MPa at 90 A, and 470 MPa at 110 A.
- 3) As the welding current value was decreased, and hence the heat input decreased, the improvement in mechanical properties was observed.
- 4) While both methods have approximately the same tensile strength and yield limit, the ductility values obtained by MIG method were much higher than those of the TIG welding conditions.
- 5) A more uniform hardness distribution was obtained in the TIG-welded structures, but grain structure and orientation were found to be better in the MIG method.

International Journal of Innovative Research in Science, Engineering and Technology

(An ISO 3297: 2007 Certified Organization)

Vol. 6, Special Issue 10, May 2017

ACKNOWLEDGEMENT

This study was presented at ICETAS2017 as an oral presentation.

REFERENCES

- [1] Odabaş Can , PaslanmazÇelikler, As Kaynak, www.askaynak.com.tr/contents/34/20110704120329_paslanmaz-celikler.pdf
- [2] PaslanmazÇelikÇeşitleri, EkipMühendislik, <http://www.ekipmuhendislik.com.tr/paslanmaz-celik-cesitleri.html>
- [3] Yan,J., Gao M., and Zeng X., “Study on microstructure and mechanical properties of 304 stainless steel joints by TIG , laser and laser-TIG hybrid welding”, Optics and Lasers in Engineering, 48,512-517, 2010.
- [4] Nakhaei R. ,Khodabandeh A. , Najafi H., “Effect of Active on Weld Shape and Microstructure of Advanced A-TIG-Welded Stainless Steel”, Acta Metall.Sin. (Engl. Lett.), 29(3) , 295-300 , 2016.
- [5] Kumar S. , Shahi A.S., “Effect of heat input on the microstructure and mechanical properties of gas tungsten arc welded AISI 304 stainless steel joints”, Materials and Design , 32 , 3617-3623 , 2011.
- [6] Pal K. , Pal S.K., “Effect of Pulse Parameters on Weld Quality in Pulsed Gas Metal Arc Welding: A Review”, ASM International , 20 , 918-931 , 2011.
- [7] Lothongkum G. , Chaumbai P. , Bhandhubanyong P., “TIG pulse welding of 304L austenitic stainless steel in flat, vertical and overhead positions”, Journal of Materials Processing Technology , 89-90 , 410-414 , 1999.
- [8] Meric C. , Karabas O. , Babayev Y. , Demirkıran K., “An investigation of the weld region of AISI 304, AISI 316L and AISI 431 stainless steels joined by GTAW”, Journal of Qafqaz University-Mechanical and Industrial Engineering, Volume1, Issue 1, 73-81 , 2013.
- [9] Eşme U. , Bayramoğlu M. , Geren N. , Serin H., “TIG KaynağındaKaynakDayanımının Taguchi MetoduylaOptimizasyonu”, TİMAK-TasarımİmalatAnalizKongresi , Balıkesir , 2006.
- [10] Shinoda T. , Ueno Y. , and Masumoto I., “Effect of Pulsed Welding Current on Solidification Cracking in Austenitic Stainless Steel Welds”, Transactions of the Japan Welding Society , Vol. 21 , No. 1 ,1990.
- [11] Miao Y. , Xu X. , Wu B. , Han D. , Zeng Y. , Wang T., “Effects of bypass current on arc characteristics and metal transfer behaviour during MIG-TIG double sided arc welding”, Journal of Materials Processing Technology , 224 , 40-48 , 2015.
- [12] 308L Argon Tig Kaynak Teli, http://www.oerlikon.com.tr/ti_308l_argon_tig_kaynak_teli.html