

Heat Transfer Enhancement Perforations: A Review

Aju Joseph¹, Amal Dev C George², Aneesh K³, Fabin Shafi⁴, Jijo Joseph⁵, Arunraj A⁶

UG Scholar, Department of Mechanical Engineering, Jyothi Engineering College, Thrissur, Kerala, India¹⁻⁵

Assistant Professor, Department of Mechanical Engineering, Jyothi Engineering College, Thrissur, Kerala, India⁶

ABSTRACT: Fin heat sinks are a great deal to increase heat transfer in applications such as cooling of electronic components, (Integrated processing units, chipset and hard disk drives), heat exchangers ,engines etc and can sometimes be an economical solution to heat transfer problems. Perforated heat sink gives higher heat transfer rate compared to solid fin heat sink by varying the different parameter like shape of fin, diameter of Perforations ,number of Perforations higher heat transfer rate can be accomplished. The present paper reviews the literature which deals with heat transfer enhancement by using perforations.

KEYWORDS: Heat transfer, Perforation, Heat sink.

I. INTRODUCTION

Heat sink is a device which absorbs the heat from heated component and dissipates heat to surrounding air. The removal of excessive heat from system components is essential to avoid the damaging effects of burning or overheating .Fins are surfaces that extend from an object to increase the rate of heat transfer to or from the environment by increasing convection. The amount of conduction, convection, or radiation of an object determines the amount of heat it transfers. Air cooling is the most widely used technique for heat rejection. Heat sink dissipates heat to surrounding air by convection. In forced convection heat dissipated by means of some external sources such as fans.

In natural convection, the extended surfaces are used which increases surface area by adding fins to the surface in order to achieve required rate of heat transfer. Heat transfer from a pin fin heat sink depends on many parameters; shape and size of the fins, spacing between the pin fins, number of pin fins, perforation number, perforation diameter, thermal conductivity, the type of flow and the fluid, temperature difference between the heat sink and the fluid. Fins are used in a large number of applications to increase the heat transfer from surfaces. Typically, the fin material has a high thermal conductivity. The fin exposed to a flowing fluid, which cools or heats it, with the high thermal conductivity allowing increased heat being conducted from the wall through the fin.

- Therefore, the enhancement of heat transfer is an important subject of thermal engineering. Perforation on fin also helps to reduce the overall size, weight and cost of heat sink. The design of cooling fins is encountered in many situations and thus examining heat transfer in a fin as a way of defining some criteria for design.

II. LITERATURE REVIEW

Ehteshum et al [1] numerically proved that “for all cases perforated fins have higher heat transfer coefficient compared to that of solid fin. It is especially true for fins with larger size and higher number of perforations. It is found that there is a significant rise of heat transfer coefficient values between fins with one perforation of 2 mm compared to that with one perforation of 3 mm.” Fig: 1 shows the relation between Thermal Resistance and Reynolds Number, it is evident from the graph that the thermal resistance of the solid fin is higher than other perforated fins. The value of thermal resistance decreases with larger perforations and for higher number of perforations.

International Journal of Innovative Research in Science, Engineering and Technology

(An ISO 3297: 2007 Certified Organization)

Website: www.ijirset.com

Vol. 6, Issue 1, January 2017

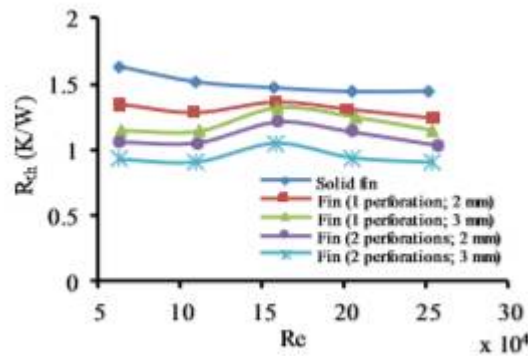

Figure 1 Effect of Reynolds number on thermal resistance

Comparative results of fin efficiency with perforation is shown in fig.2. It can be seen that the efficiency increases with increasing perforation and with number of perforations. Since the perforated fins have larger effective heat transfer area compared to that of solid fin, the rate of heat transfer also increases with perforation. This is what because perforated fins have higher efficiencies. [1]

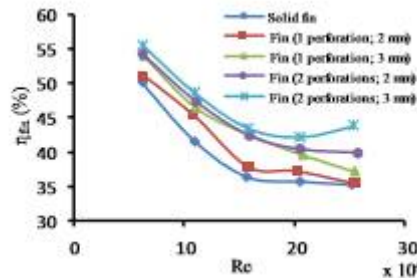

Figure 2 Effect of Reynolds number on fin efficiency

Fig.3 represents the relationship between the fin effectiveness and Reynolds number. The results are similar to that of fin efficiency. However, both efficiencies and effectiveness decrease with increasing air velocity i.e. Reynolds number.

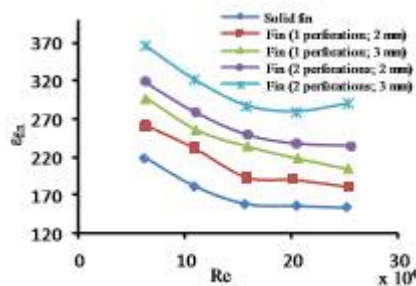

Figure 3 Effect of Reynolds number on fin effectiveness

Thermal performance of perforated and solid fins is numerically investigated by Ismail et al with circular and rectangular perforations. “Generally optimization of fins is focused on to maximize heat dissipation rate and to minimize pressure drop for a given mass or volume of the heat sink. Perforated fins have higher contact surface with

International Journal of Innovative Research in Science, Engineering and Technology

(An ISO 3297: 2007 Certified Organization)

Website: www.ijirset.com

Vol. 6, Issue 1, January 2017

the fluid in comparison with the solid fins. Thus the perforated fins have higher effectivity than the solid fins. Again, it is found that though circular and square perforated fins have almost the same amount of heat removal rate but circular perforated fins have significantly less pressure drop than that of square perforated fins. Hence, fin optimization for practical applications can be achieved by the new types of perforated fins” [4]

Some papers also pointed to the optimization of fins by doing perforations on them, M.R. Shaeri et al [2] in their paper denoted the effect of perforations in fin optimization. “Due to perforations, the shape and position of formed wakes in the back of perforated fins in any height of fin are different with wakes for solid. Inserting perforations in solid fin, the weight of fin decreases and this is the second goal of fin optimization” [2]. Table 1 shows the percent of reduction of fin’s weight by considering perforations. It is clear that as the perforation increases weight of the fin reduces. This enables to achieve maximum rate of heat transfer with minimum material use.

Table 1: Percentage of weight reduction of solid fin due to creation of perforations

Number of perforations	1	2	3	4	6	8
Percentage of weight reduction	5.56	11.11	16.67	22.22	33.33	44.44

The optimization of fins can be made by either minimizing the volume for a required heat dissipation or maximizing the heat dissipation for any given fin volume. It is very clear that the volume of fins greatly reduced by having perforations. As the number of perforations increase the volume correspondingly get reduced. As a result of high reduction in weight, cost of manufacturing of fins and related equipment such as heat sinks will be highly remarkable. The benefit of this weight reduction is accompanied of heat transfer enhancement by considering the present slots along the fins. Accordingly by use of perforated fins, especially with more perforations, both goals of fin’s optimization will be improved.

Since these perforations are an obstruction to the flow of heat there occur some temperature drop across their vicinity. “The temperature drop along the perforated fin length is consistently higher than that for the equivalent non-perforated fin. It contains a larger number of perforations higher than the perforated fin that contained a small number of perforation. The gain in heat dissipation rate for the perforated fin is a strong function of the perforation dimension and lateral spacing. Decreasing the perforation dimension reduces the rate of temperature drop along the perforated fin. Heat transfer coefficient for perforated fin that contained a larger number of perforations higher than the perforated fin that contained a small number of perforation” [3].

Sahin et al [12] in 2008 conducted a performance analysis of a heat exchanger having perforated square fins. In their study, the overall heat transfer, friction factor and the effect of the various design parameters on the heat transfer and friction factor for the heat exchanger equipped with square cross-sectional perforated pin fins were investigated experimentally. Enhancement efficiencies increased with decreasing Reynolds number. Therefore, relatively lower Reynolds number led to an improvement in the heat transfer performance.

Kundu et al [5] in 2014 carried out an analytical study for the optimization of the shape of porous fins under both convection and radiation. “The fin performance of porous fins enhances with radiation effect whereas this parameter declines in the case of solid fins. The fin volume required to transfer heat effectively is always higher in porous fins compared to that of solid fins. In addition, the total volume of fin expands with the porosity. The influence of variable heat transfer coefficient on the fin volume does not change remarkably in comparison with that variation of the porosity. On the other hand, material volume of porous fins (U^*) does have a significant effect on the porosity as well as the heat transfer coefficient. Again for a high porosity, material volume does not change significantly with any variation of heat transfer coefficient as a temperature dependent function. As the material volume of porous fins becomes a minimum for a maximum possible porosity to be selected based on the manufacturing aspect, it may be an utmost importance to

International Journal of Innovative Research in Science, Engineering and Technology

(An ISO 3297: 2007 Certified Organization)

Website: www.ijirset.com

Vol. 6, Issue 1, January 2017

determine the envelop shape of porous fins in a practical design application where an addition of weight creates always an overburdened”.

Shaeri et al [9] made a three-dimensional numerical computation for turbulent fluid flow and convective heat transfer around an array of rectangular solid and new design of perforated fins with different numbers and two various sizes of perforations. For fins with perforation, drag force reduces. Also drag ratio becomes smaller by increasing Reynolds number. With increase of perforations flow becomes complicated, average friction coefficient decreases and solid fin has the highest value of C_f . Fins with the same porosity but larger window sizes have higher Nusselt number than fin with smaller windows. By increasing number of perforations, temperature difference between the fin base and fin tip becomes larger.

A similar study on improvement of heat transfer with perforated circular holes in finned tubes of air-cooled heat exchanger was conducted by Lee et al [6] in 2012. . “The increase in the convective heat transfer coefficient was due to the perforations which reduced the recirculation region caused by flow separation. For the effects of the perforations on the pressure drop across tube bundle, the 2-hole PCFT and 4hole PCFT cases showed increases in the pressure drop by 0.68% and 2.08%, respectively. The fin factor for the 2-hole PCFT case was 5.19, whereas that for the 4-hole PCFT case was 1.59. The 2-hole PCFT case showed a better performance in terms of the fin factor than the 4-hole PCFT case. Further investigation is recommended to study the effect of the perforation location on the convective heat transfer characteristics of perforated finned tubes”.

Shaeri et al [7] experimented on the effects of perforation size on laminar heat transfer characteristics of the fin. They select the fin with high porosity and varied the number and sizes of its perforations without changing its porosity, fig.4. shows the different types of arrangement used in their experiment. According to them, “Between two perforated fins at the same porosity, the one with more perforations has the higher friction drag due to having more floors and ceilings because of the extra perforations. However, since the velocity in laminar flow is low inside the perforations, the difference in friction drag is not sensible in low Reynolds numbers between two perforated fins at the same porosity”.

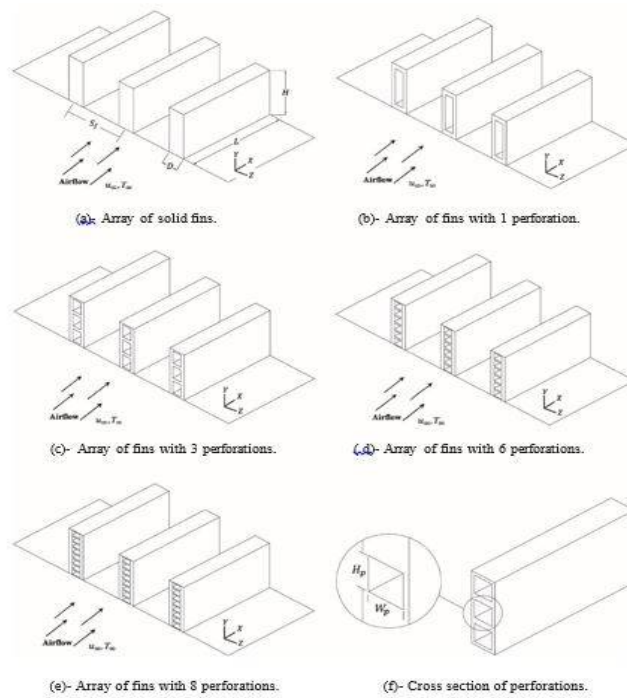

Figure 4 Configurations of fin arrays

International Journal of Innovative Research in Science, Engineering and Technology

(An ISO 3297: 2007 Certified Organization)

Website: www.ijirset.com

Vol. 6, Issue 1, January 2017

Their paper concluded that, “At the same porosity, the perforated fins with a smaller number of perforations (larger in perforation sizes) enhance the heat transfer rate more efficiently in such a manner that by using perforated fins with one perforation, the heat transfer rate is enhanced nearly 80%”.

Heat transfer and friction factor characteristics in the air to water heat exchanger equipped with the typical circular-ring (TCR) and perforated circular-ring (PCR) turbulators are investigated experimentally by Sheikholeslami et al [20]. They considered the effects of the pitch ratio and number of perforated hole on flow and heat transfer characteristics. Nusselt number increases with increase of Reynolds number and number of perforated hole and it decreases with increase of pitch ratio. Friction factor enhances with increase of Reynolds number and it decreases with increase of number of perforated hole and pitch ratio.

AlEssa et al [13] carried out a study in Enhancement of natural convection heat transfer from a fin by triangular perforation of bases parallel and toward its tip as shown in fig.5

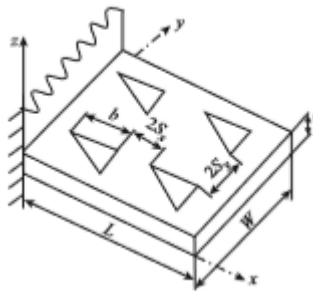

Figure 5 Fin with equilateral triangular perforations

The temperature drop along the perforated fin length is consistently larger than that on an equivalent non-perforated fin. For certain values of triangular dimensions, the perforated fin can enhance heat transfer. The magnitude of enhancement is proportional to the fin thickness and its thermal conductivity. The extent of the heat dissipation rate enhancement for perforated fins is a complicated function of the fin dimensions, the perforation geometry and the fin thermophysical properties [13].

Sara et al [18] carried out a test on Heat-transfer enhancement in a channel flow with perforated rectangular blocks and made a conclusion that perforations in the blocks enhances the heat transfer and the enhancement increases with increasing the degree of perforations. For a given number of blocks, with each having same number of perforations, the diameter plays a more important role in the enhancement of the heat transfer than the number of perforations does. Thus, it may be more advantageous to obtain higher degree of perforation by increasing the diameter of perforations rather than their numbers.

Enhancement of heat transfer can also be achieved with the use of pin fins. A pin fin heat sink is a heat sink that has pins that extend from its base. The pins can be cylindrical, elliptical or square. Fig.6 shows cylindrical pin fins that having perforations. Pin fins used for improving heat transfer where size is a constraint. Since the heat sinks may consumes up to 40% of total system volume, a smaller and more compact one is needed. Elshafei [8] investigated about the Natural convection heat transfer from a heat sink with hollow/perforated circular pin fins.

International Journal of Innovative Research in Science, Engineering and Technology

(An ISO 3297: 2007 Certified Organization)

Website: www.ijirset.com

Vol. 6, Issue 1, January 2017

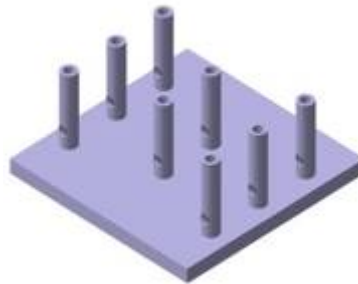

Figure 6 Pin fin

Due to their potentially high heat transfer characteristics, less sensitive to air flow pattern and surface area density, round pin fin array heat sinks have been of interest to designers of electronic equipment and turbine cooling applications.

Eren et al [14] experimented the effect of grooved pin-fins in a rectangular channel on heat transfer augmentation and friction factor using Taguchi method. The most important factor affecting the friction factor was the pin-fin geometry with the contribution value of 47.54%. The most important parameter affecting the thermal performance factor was determined to be the pin-fin geometry with the contribution value of 57.79%. For all the designs of pin-fin geometries, it was seen that the Nusselt number increased as the Reynolds number increased.

AnusayaSalwe et al. [15] compared solid pin fin and perforated pin fin in forced convection. They varied the numbers of horizontal perforations and diameters of horizontal perforation on every pin-fin. They found that, Pressure drop for perforated pins was less compared to solid fins. The friction factor decreases with increasing number of perforation therefore perforated pin fins consume less pumping power than the solid pins for the same thermal performance.

Saurabh D. Bahadure, and G. D. Gosavi [16] carried out the thermal performance of a pin fin heat sink. In experiment, they varied the material of pin fin such as Aluminium, Copper and mild steel and number of perforation on pin fin from 1 to 3 respectively. They found that the material having higher thermal conductivity gives more heat transfer rate. The copper material shows higher heat transfer coefficient compared to aluminium and mild steel. The average heat transfer coefficient is higher for three perforations compared to solid, single, and two perforations respectively.

Aliabadi et al [17] conducted an experiment on Role of channels hape on performance of plate fin heat exchangers, the values of the heat transfer coefficient and j factor are higher for perforated ones than plain channels

Li et al [10] were performed some numerical studies on natural convection heat transfer from radial heat sinks with perforated ring. The effects of perforation number (0–6), perforation diameter (0–3 mm), and perforation length (1.5–6 mm), and orientations angle (0–180) on the thermal performance were investigated by them. They concluded that radial heat sinks with a perforated ring obviously have better thermal performance than that with imperforated ring. Upwardly oriented radial heat sinks have the best thermal performance while sideward oriented radial heat sinks yield worst thermal performance. The geometric parameters of perforation is shown to affect the thermal performance of heat sink significantly at relatively higher heat transfer rate, especially for upward and sideward orientations. The thermal resistance of the radial heat sink with optimized perforated ring was shown to be less than that of imperforated ring by

International Journal of Innovative Research in Science, Engineering and Technology

(An ISO 3297: 2007 Certified Organization)

Website: www.ijirset.com

Vol. 6, Issue 1, January 2017

17%, while reducing the mass of ring by up to 37%. This can be attributed to the unhindered natural convective flow through the perforation.



Figure 7: Example for radial heat sink

CHO et al [16] experimentally investigated about the mass (heat) transfer in and near a circular hole in a flat plate, at the windward surface, the local transfer coefficient increases rapidly as the flow approaches the hole entrance due to acceleration of the flow resulting in a thinning boundary layer. Increasing the area of the active domain results in a relatively minor increase in the total mass transfer.

Huang et al [21] numerically investigated about the enhancement of natural convection heat transfer from horizontal rectangular fin arrays with perforations in fin base. They listed out that under a fixed total perforation length, the conditions with more distributed shorter perforations exhibit higher improvements. The overall convective heat transfer coefficients of the perforated fin arrays lie between two limits corresponding to an impermeate fin arrays and vertical parallel plates, respectively. The overall convective heat transfer coefficients of the perforated fin arrays increase with increasing total perforation length.

The effect of the various parameters like geometry, Reynolds number and friction factor on the heat transfer for the rectangular fins with square and circular perforation are investigated experimentally Dhanawade et al [8]. They concluded that the most important parameter affecting the heat transfer is Reynolds number and secondly and geometry of perforation. The Nusselt numbers of perforated fin arrays as well as solid fin arrays increases with increase in Reynolds number. Percentage improvement in Nu of Perforated fin arrays over solid fin array is found. Result shows that average of percentage improvement of square perforated fin arrays is more than fin arrays of circulated perforated fin of same size. Friction factor slightly increases with increase in the size of perforation. Utilization of perforated fins increases heat dissipation rate, simultaneously reduction in fins weight, low weight means saving material of fin and which decreases the expenditure on the fin material and related equipment. Hence it may be utilized for cooling of air cooled I C engines and many other industrial applications.

Karabacak et al [19] performed Forced convection heat transfer and pressure drop for a horizontal cylinder with vertically attached impermeate and perforated circular fins. In the Re numbers below the critical value, heat transfer on the finned heater of impermeate state was 6% higher than for the perforated finned state. However, in the Re numbers above the critical value, heat transfer on the finned heater of perforated state was 12% higher than for the impermeate finned state.

Sara et al [15] studied the behaviour of heat transfer of perforated flat fin with solid fins and found that for both the solid and the perforated blocks, increases in Re lead to decreases in the performance. For the perforated blocks, the higher the perforation diameter, perforated area open area ratio, and inclination of the perforation holes towards the surface of the plate, the better their heat transfer enhancement performance.

International Journal of Innovative Research in Science, Engineering and Technology

(An ISO 3297: 2007 Certified Organization)

Website: www.ijirset.com

Vol. 6, Issue 1, January 2017

Yadav et al [11] numerically investigated about the heat transfer in extended surface microchannel and made these conclusions, Heat transfer performance of plain microchannel is significantly improved by extended surface microchannel. Performance of upstream finned microchannel is better than other extended surface microchannel at low Reynolds number, but at high Reynolds number heat transfer performance of complete finned microchannel is the best. Heat transfer performance of upstream finned microchannel is always better than downstream finned microchannel.

MonojBaruah et al. [24] investigated the performance of elliptical pin fins which arranged in a staggered manner. Two types of elliptical pin fins have been taken for the study, namely, solid elliptical and perforated elliptical pin fins. The pin fins were made of Aluminium with thermal conductivity 202.4 W/m-k. The height of the both pin fins was kept the same as 23.0 mm. Three perforations were provided on elliptical pin fins and its performance compared with corresponding solid elliptical pin fin. They have observed that, the perforated elliptical pin fins gives more heat transfer and less pressure drop than solid elliptical pin fin.

Ji-Jinn Foo et al. [25] studied the forced convective heat transfer with perforated pin fin array subjected to a vertical impinging flow. They investigated rate of heat transfer and pressure drop by varying the number of horizontal perforation and the diameters horizontal and vertical perforation on pin fin. Further their performance compared with the solid pins. All pin fin array were made of aluminium material which contains 14 pins of 8 mm diameter and 50 mm height. All cases studied for four different inlet velocities such as 5, 10, 15 and 20 m/s respectively. They observed that, the perforated pin fin array gives more heat transfer than the corresponding solid pins. The pressure drop decreases with increase in number of perforation and diameter of perforation; therefore perforated fins consume less pumping power than solid.

H. Saadat et al. [26] studied heat transfer from a perforated fin array with cross perforations. They have observed that cross perforation gives higher heat transfer than that of single direction perforation. Murtadha Ahmed and Abdul Jabbar N. Khalifa [18] compared solid and perforated square pin fin heat sinks in natural convection. They found that the perforated pin fins gives better heat transfer than that of solid pins. The temperature drop across perforated pin fin was less than that of solid pin fins.

E.A.M.Elshafei [27] studied the natural convection heat transfer from circular pin fin heat sinks. In this study, they compared solid circular pin fins with perforated circular pin fins in staggered arrangement. The base plate and the pin-fins were made of aluminium with a thermal conductivity of 237 W/(mK). The range of Rayleigh number was taken from $3.8 \times 10^6 \leq Ra \leq 1.65 \times 10^7$. They also tested performance of heat sink for two different orientations such as upward and sideward orientations and observed that, the perforated pin fins gives better heat transfer in sideward arrangement than upward arrangement. For the same heat supplied, the temperature difference between the base plate and surrounding air was less for perforated pin fin heat sink than that of solid pin.

AnupamDewan et al. [28] investigated forced convective heat transfer from an array of circular pin fins. The arrays of solid and perforated pin fins are mounted on a flat plate in staggered manner along the flow direction. Aluminium material was selected as fin material. The air inlet velocities varied from 1.5 m/s to 6.0 m/s. The height and diameter of the pin fins was taken 23.0 mm and 2.3 mm respectively. The perforation diameter 1.15 mm was provided on pin fin at the heights of 11.5 mm from the base. They found that perforated fin enhanced the heat transfer and reduced the pressure drop. The circular perforation on pin fin reduces the weight and the cost of pin fin.

International Journal of Innovative Research in Science, Engineering and Technology

(An ISO 3297: 2007 Certified Organization)

Website: www.ijirset.com

Vol. 6, Issue 1, January 2017

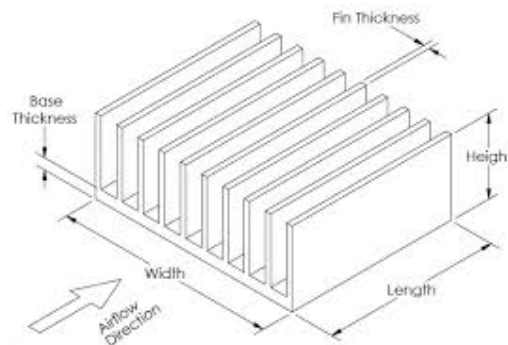

Figure 8: Plate fin type heat sink

Dong-Kwon Kim et al. [23] compared plate and pin-fin heat sinks subjected to an impinging flow. They performed experiment for different flow rates and channel widths. They used volume averaging method to predict pressure drop and the thermal resistance. The material of heat sinks was aluminium alloy 6061 with thermal conductivity of 170 W/(mK). The result indicate that optimized pin-fin heat sinks shows lower thermal resistances when dimensionless pumping power is small and the dimensionless length of heat sinks is large

Xiaoling Yu et al. [22] compared thermal performance two types heat sink such as plate fin heat sink and plate-pin fin heat sink. The plate pin fin heat sink was constructed by providing columnar pin fin in between plate fins. The material used for heat sinks is aluminium having thermal conductivity of 202 W/(mK). The base heat sink was heated uniformly with a heat load of 10 W and varied wind velocities through passages of the heat sink such as 6.5, 8.0, 10.0 and 12.2 m/s respectively. They have observed that plate pin fin heat sink gives lower thermal resistance and more pressure drop than plate fin heat sinks.

III. SUMMARY

This review reveals that convective heat transfer from fin depends on various factors as geometrical parameters, operating parameters, fin material used, fin array in orientation, number of fins etc. But geometrical parameters affect most. As there are limitations to increase the size of fin array in order to increase surface area due to limitations on proposed length and width of fin array, optimal fin spacing found most important factor to enhance convective heat transfer. Instead of only going for natural convection or forced convection, mixed convection was also proposed for better enhancement in convective heat transfer as mixed convection enhanced natural convection.

- The perforated pin fin array is economical.
- The heat transfer enhancement is depending on pin fin dimensions, the perforation geometry, and number of perforation and thermal conductivity of material.
- The most important parameter affecting the heat transfer is Reynolds number
- Inserting perforations in solid fin, the weight of fin decreases and this is an important goal of fin optimization

REFERENCES

- [1]. MehediEhteshum, Mohammad Ali, Md. Quamrul Islam, MuhsiaTabassum. "Thermal and hydraulic performance analysis of rectangular fin arrays with perforation size and number. 6th BSME International conference on thermal engineering (ICTE 2014)
- [2]. M.R. Shaeri, M. Yaghoubi, Mechanical Engineering Department, School of Engineering, Shiraz University, Shiraz 71348-51154, Iran
- [3]. Wadhah Hussein Abdul Razzaq Al- Doori, "ENHANCEMENT OF NATURAL CONVECTION HEAT TRANSFER FROM THE RECTANGULAR FINS BY CIRCULAR PERFORATIONS", International Journal of Automotive and Mechanical Engineering (IJAME) ISSN: 1985-9325(Print); ISSN: 2180-1606 (Online); Volume 4, pp. 428-436, July-December 2011.

International Journal of Innovative Research in Science, Engineering and Technology

(An ISO 3297: 2007 Certified Organization)

Website: www.ijirset.com

Vol. 6, Issue 1, January 2017

- [4]. Md. Farhad Ismail, M.O. Reza, M.A. Zobaer, Mohammad Ali, Numerical investigation of turbulent heat convection from solid and longitudinally perforated rectangular fins, 5th BSME International Conference on Thermal Engineering.
- [5]. Balaramkundu, Kwan-Soo Lee, "Exact analysis for minimum shape of porous fins under convection radiation heat exchange with surroundings" International Journal of Heat and Mass Transfer
- [6]. Dong H. Lee , Jin M. Jung , Jong H. Ha , Young I. Cho, "Improvement of heat transfer with perforated circular holes in finned tubes of air-cooled heat exchanger", International Communications in Heat and Mass Transfer
- [7]. Mohammad Reza Shaeri, Tien-Chien Jen, "The effects of perforation sizes on laminar heat transfer characteristics of an array of perforated fins", Energy Conversion and Management.
- [8]. Kavita H. Dhanawade, Vivek K. Sunnapwar and Hanamant S. Dhanawade, "Thermal Analysis of Square and Circular Perforated Fin Arrays by Forced Convection", International Journal of Current Engineering and Technology E-ISSN 2277 – 4106, P-ISSN 2347 – 5161
- [9]. M.R. Shaeri, M. Yaghoubi , K. Jafarpur, "Heat transfer analysis of lateral perforated fin heat sinks", Applied Energy 86(2009)2019–2029
- [10]. Bin Li, SoraJeon, Chan Byon, "Investigation of natural convection heat transfer around a radial heat sink with perforated ring", International Journal of Heat and Mass Transfer.
- [11]. VikasYadav, KuldeepBaghel, Ritunesh Kumar, S.T. Kadam, "Numerical investigation of heat transfer in extended surface microchannel", International Journal of Heat and Mass Transfer.
- [12]. BayramSahin, AlparslanDemir, "Performance analysis of a heat exchanger having perforated square fins", Applied Thermal Engineering 28 (2008) 621–632.
- [13]. Abdullah H. AlEssa, Mohamad I. Al-Widyan, "Enhancement of natural convection heat transfer from a fin by triangular perforation of bases parallel and toward its tip", Appl. Math. Mech. -Engl. Ed., 2008, 29(8):1033–1044
- [14]. M. Eren, S. Caliskan, "Effect of grooved pin-fins in a rectangular channel on heat transfer augmentation and friction factor using Taguchi method", International Journal of Heat and Mass Transfer 102(2016)1108–112
- [15]. O.N. Sara, T. Pekdemir, S. Yapici, H. Ersahan, "Thermal performance analysis for solid and perforated blocks attached on a flat surface in duct flow", Energy Conversion & Management 41 (2000) 1019-1028
- [16]. H. H. CHO, M. Y. JABBARI, R. J. GOLDSTEIN, "Experimental mass (heat) transfer in and near a circular hole in a flat plate", 1997 Elsevier Science Ltd
- [17]. M. Khoshvaght-Aliabadi, F. Hormozi A. Zamzamin, "Role of channel shape on performance of plate fin heat exchangers: Experimental assessment", International Journal of Thermal Sciences
- [18]. O.N.Sara, T. Pekdemir, S. Yapici, M. Yilmaz, "Heat-transfer enhancement in a channel flow with perforated rectangular blocks", International Journal of heat and Fluid Flow 22 (2001) 509-518
- [19]. RasimKarabacak, GülayYakar, "Forced convection heat transfer and pressure drop for a horizontal cylinder with vertically attached imperforate and perforated circular fins", Energy Conversion and Management
- [20]. M. Sheikhholeslamif, M. Gorji-Bandpy, D.D. Ganji, "Experimental study on turbulent flow and heat transfer in an air to water heat exchanger using perforated circular-ring", Experimental Thermal and Fluid Science 70 (2016) 185–195
- [21]. Guei-Jang Huang, Shwin-Chung Wong, Chun-Pei Lin, "Enhancement of natural convection heat transfer from horizontal rectangular fin arrays with perforations in fin base", International Journal of Thermal Sciences 84 (2014) 164e174
- [22]. Xiaoling Yu , JianmeiFeng, QuankeFeng, Qiuwang Wang, "Development of a Plate-Pin Fin Heat Sink and its Performance Comparisons with a Plate Fin Heat Sink", Applied Thermal Engineering 25, 2005, pp.173–182
- [23]. Dong-Kwon Kim, Sung Jin Kim , Jin-Kwon Bae, "Comparison of Thermal Performances of Plate-Fin and Pin-Fin Heat Sinks Subject to an Impinging Flow", International Journal of Heat and Mass Transfer 52 , 2009, pp. 3510–3517.
- [24]. MonojBaruah, AnupamDewan and P. Mahanta, "Performance of Elliptical Pin Fin Heat Exchanger with Three Elliptical Perforations", ISSR Journals, Volume 3 (2), June 2011, pp. 65-70.
- [25]. Ji-Jinn Foo, Shung-YuhPui, Yin-Ling Lai, Swee-Boon Chin, "Forced Convective Heat Transfer Enhancement with Perforated Pin Fins Subject to an Impinging Flow", SEGi Review, volume 5, number 1, July 2012, pp. 29-40.
- [26]. H. Saadat , M. M. Tavakol , M. Yaghoubi, "Experimental Study on Heat Transfer from a Perforated Fin Array with Cross Perforations ", The 2nd Iranian Conference on Heat and Mass Transfer-ICHMT2014, Iran, 19-20 November, 2014.
- [27]. E.A.M. Elshafei, "Natural Convection Heat Transfer from a Heat Sink with Hollow/Perforated Circular Pin Fins", Energy 35, 22 April 2010, pp. 2870-2877.
- [28]. AnupamDewan, Rajesh Kumar Shukla, "Computation of Turbulent Convective Heat Transfer in a Hollow Circular Pin Fin Heat Exchanger", Proceedings of the 21st National and 10th ISHMT-ASME Heat and Mass Transfer Conference, IIT Madras, India, 27-30 December 2011.