

# The Effect of Varying Location and the Shape of the Annular Ribs on the Combustion Characteristics and Heat Transfer for Premixed Flame

Amr Ali Abbas Ali El-keraby<sup>1</sup>, Mahmoud Kamal<sup>2</sup>, Hany El-Sayed Abd El-Haliem Saad<sup>3</sup>

P.G. Student, Department of Mechanical Power Engineering, Faculty of Engineering, Ain Shams University, Egypt<sup>1</sup>

Professor, Department of Mechanical Power Engineering, Faculty of Engineering, Ain Shams University, Egypt<sup>2</sup>

Associate Professor, Department of Mechanical Power Engineering, Faculty of Engineering,

Ain Shams University, Egypt<sup>3</sup>

**ABSTRACT:** An experimental study is carried out to investigate the effect of using the annular ribs on the heat transfer characteristics, combustion and gas analysis in premixed flame burner. These annular ribs are inserted coaxially with a longitudinal flame tube at different locations. A test rig is constructed to investigate the effect of using squared and triangle annular ribs shapes and the location of annular ribs relative to the burner tip on the heat transfer characteristics. The test rig is constructed to carry out the measurements and experimental work using LPG fuel. The effects of changing the shape and the axial location of the annular ribs on the profile of the heat flux, combustion through the firing tube are achieved. The results of the present work indicate that using the annular ribs in combustion process increase the rate of the heat transfer across the furnace walls. The effect of the triangle rib is investigated and the results showed that the effect of triangle ribs on the heat flux is greater than the effect of the squared one. Also there was a significant enhancement of the flame and wall surface temperatures due to using ribs. At the insertion point of the rib ( $X/D = 2.029$ ), each of maximum surface temperature, flame temperature and maximum heat transfer rate are found.

**KEYWORDS:** Annular rib, premixed flame burner, Heat transfer, Combustion, Gas analysis.

## I. INTRODUCTION

Heat transfer and combustion are important concepts that are a part of everyday life. Heat, combustion, energy and temperature pervade our lives. We give a great attention to hot and cold in deciding what we will wear during the whole day. Many of us have heating and cooling devices in our homes, schools and workplaces that control and adjust the suitable temperature for our bodies during the day and night to keep us as comfortable as possible without spending too much money. Heat transfer, also referred to simply as heat, is defined as the movement of thermal energy from one system to another system of different temperature. These systems could be two solids, a solid and a liquid or gas, or even within a liquid or gas. Heat is a concept used throughout various engineering fields. It is particularly important for civil, mechanical and chemical engineers because heat transfer plays an important role in material selection, machinery efficiency, proper design and reaction kinetics, respectively.

Because of all of these situations and many others and the importance of combustion and heat transfer for the human's life, a lot of researches were and will be carried out to investigate these important topics and how to enhance them. Liou and Hwang [1,2] investigated experimentally the performance of square, triangular and semi-circular ribs and found that the square ribs give the best heat transfer performance among them. This is contrary to the experimental result of Ahn [3] indicated that the triangular rib performs better than the square one. Tanda [4] examined the effect of transverse, angled ribs, discrete, angled discrete ribs, V-shaped, V-shaped broken and parallel broken ribs on heat

# International Journal of Innovative Research in Science, Engineering and Technology

(An ISO 3297: 2007 Certified Organization)

Website: [www.ijirset.com](http://www.ijirset.com)

Vol. 6, Issue 6, June 2017

transfer and friction and reported that 90° transverse ribs provided the lowest thermal performance while the 60° parallel broken ribs or 60° V-shaped broken ribs yielded a higher heat transfer augmentation than the 45° parallel broken ribs or 45° V-shaped broken ribs. Parallel angled discrete ribs were seen to be superior to parallel angled full ribs and its 60° discrete ribs performed the highest heat transfer. SooWbanAbn and Kang Pil Son [5] found that the heat transfer can be enhanced by the use of rough surfaces. Four different shapes such as a semicircle, sine wave, trapezoid, and arc were suggested to investigate the heat transfer enhancement and friction factor on rectangular duct. They measured the friction factor and heat transfer enhancement on smooth duct and compared it to the results. Square shape geometry gave the highest value because of its strongest turbulence mixing caused by rib. Non circular ducts such as the equilateral triangle, Square and rectangular ducts have lower frictional factors and heat transfer as compared to circular ducts. Chien-Nan Lin and Jiin-Yuh Jang [6] studied the use of fins with embedded wave-type vortex generators to enhance heat transfer in fin-tube heat exchangers. An infrared thermo vision is used to visualize the temperature distribution on the surface of a scaled-up plain fin and upon fins with embedded vortex generators. The current results indicate that heat transfer and friction losses are strongly dependent on the geometric parameters of the vortex generators. This study identifies maximum improvement of (120) % in the local heat transfer coefficient and an improvement of (18.5) % in the average heat transfer coefficient. Pesteei, et al [7] measured Local heat transfer coefficients on fin-tube heat exchanger with winglets using a single heater of 2 inch diameter and five different positions of winglet type vortex generators. The measurements were made at Reynolds number about 2250. Flow losses were determined by measuring the static pressure drop in the system. Results showed a substantial increase in the heat transfer with winglet type vortex generators. It was observed that average Nusselt number increased by about (46) %, while the local heat transfer coefficient was improved by several times as compared to plain fin-tube heat exchanger. In a Joardar and Jacobi [8] the effectiveness of delta-wing type vortex generators were experimentally evaluated by full-scale wind tunnel testing of a compact heat exchanger typical to those used in automotive systems. The mechanisms important to vortex enhancement methods are discussed, and a basis for selecting a delta-wing design as a vortex generator is established. The heat transfer and pressure drop performance are assessed at full scale under both dry- and wet-surface conditions for a louvered- fin baseline and for a vortex-enhanced louvered-fin heat exchanger. An average heat transfer increase over the baseline case of (21) % for dry conditions and (23.4) % for wet conditions was achieved with a pressure drop penalty smaller than (7) %. Vortex generation is proven to provide an improved thermal-hydraulic performance in compact heat exchangers for automotive systems.

Kamali and Binesh [9] studied turbulent heat transfer and friction characteristics in a square duct with various-shaped ribs mounted on one wall. The simulations were performed for four rib shapes, i.e., square, triangular, Trapezoidal with decreasing height in the flow direction, and Trapezoidal with increasing height in the flow direction. The results shown the inter-rib distribution of the heat transfer coefficient were strongly affected by the rib shape and Trapezoidal ribs with decreasing height in the flow direction provide higher heat transfer enhancement and pressure drop than other shapes. Bilenet al. [10] Presented an experimental study of surface heat transfer and friction characteristics of a fully developed turbulent air flow in different grooved tubes. Tests were performed in the Reynolds number range 10,000–38,000 and for different geometric groove shapes (circular, Trapezoidal and rectangular). Among the grooved tubes, heat transfer enhancement was obtained up to 63% for circular groove, 58% for Trapezoidal groove and 47% for rectangular groove, in comparison to the smooth tube at the highest Reynolds number ( $Re=38,000$ ).

Han et al. [11] studied experimentally the heat transfer in a square channel with ribs on two walls for nine different rib configurations for  $P/e = 10$  and  $e/H = 0.0625$ . They found that the angled ribs and 'V' ribs yield higher heat transfer enhancement than the continuous ribs and the heat transfer rate and the friction factor were highest for the 60° orientation amongst the angled ribs. For heating either only one of the ribbed walls or both of them, or all four channel walls. J. C. Han et al. [12] performed experiments on the rib-roughened surface to determine the effects of rib shape, angle of attack and pitch to rib height ratio on friction factor and heat-transfer results. They developed a general correlation for friction factor and heat transfer as function of rib shape, spacing and angle of attack and also reported that ribs at a 45° angle of attack have superior heat transfer performance at a given pumping power.

The objective of the present work is to investigate the effect of using annular ribs and its location on the combustion characteristics and heat transfer.

# International Journal of Innovative Research in Science, Engineering and Technology

(An ISO 3297: 2007 Certified Organization)

Website: [www.ijirset.com](http://www.ijirset.com)

Vol. 6, Issue 6, June 2017

## II. EXPERIMENTAL TEST RIG

In this work an experimental verification is carried out in order to investigate the effects of an annular rib on the heat transfer, combustion processes by using a pre-mixed flame along the flame tube. The fuel used is Liquefied Petroleum Gas (LPG) [60% Propane + 40% Butane] according to Gas Misr Company EN 589. Figure (1) shows the layout of the test rig. The test rig consists of cooled water furnace, air supply system, fuel supply system, mixing chamber and annular ribs. The fuel supply from pressurized bottle (5000 Pa) while the air supplied from a compressor. The feeding air is drying by using silica gel. The fuel and air are forced to the mix in the mixing chamber before entering the burner. Test rig is constructed with facilities to carry out the measurements and experimental work of produced LPG flame. Each component from the previous components has some auxiliary devices which facilities to control the flow rate of water, air and fuel such as shut off valves, dampers and reduction valves. And another devices which facilities to carry out the measurements and experimental work such as digital flow meters, flow meters for air and fuel, thermometers and thermocouples.

The flame tube is divided into four segments. Each segment has measuring holes in order to measure flame temperature and wall surface temperature, Water outlet temperature and then the heat flux is calculated based on the measured values.

The flow rates are measured by a set of digital flow meters and these flow meters are calibrated using an orifice (error is equal to  $\pm 5.6\%$ ). Thermocouples were used to measure temperatures of the flame and the metal of the pipe. These thermocouples are calibrated (error is equal to  $\pm 8\%$ ). Manometers were used to measure the water outlet temperature. Air and fuel flow meters (errors are  $\pm 2\%$  and  $1.25\%$  respectively) were used to adjust the ratio between them for each certain type of combustion. The heat transfer and firing rate are calculated based on the above measurements. The heat transfer is calculated once without inserting the annular rib and compared with after inserting the annular rib along the fire tube.

In this study two cross sectional area of the annular ribs (rectangular and triangular) are used. These annular ribs will be moved across the firing tube in order to investigate its effect on the heat transfer and combustion process. Figures (2 a and b) show the squared and triangle ribs and its dimensions and geometry.

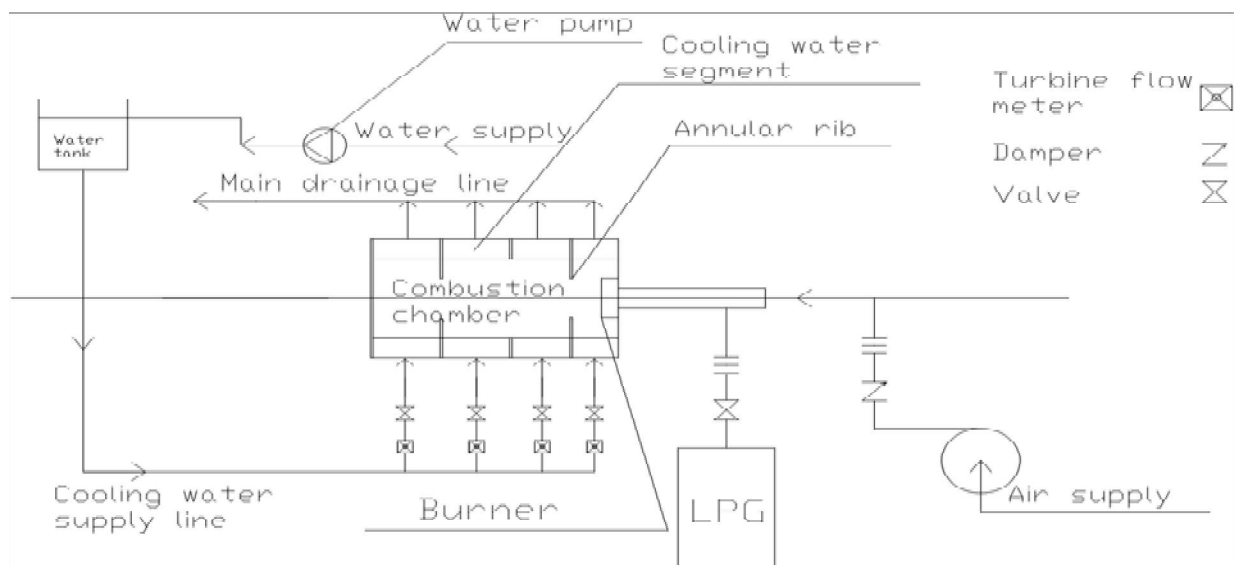

Fig. (1): Test rig illustration

# International Journal of Innovative Research in Science, Engineering and Technology

(An ISO 3297: 2007 Certified Organization)

Website: [www.ijirset.com](http://www.ijirset.com)

Vol. 6, Issue 6, June 2017

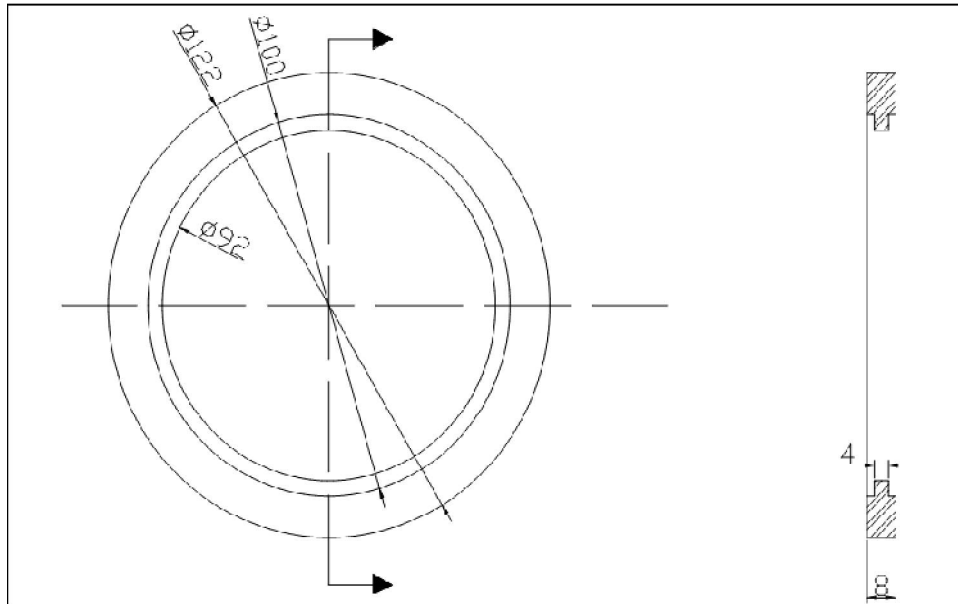

Fig. (2a): Squared Rib Geometry

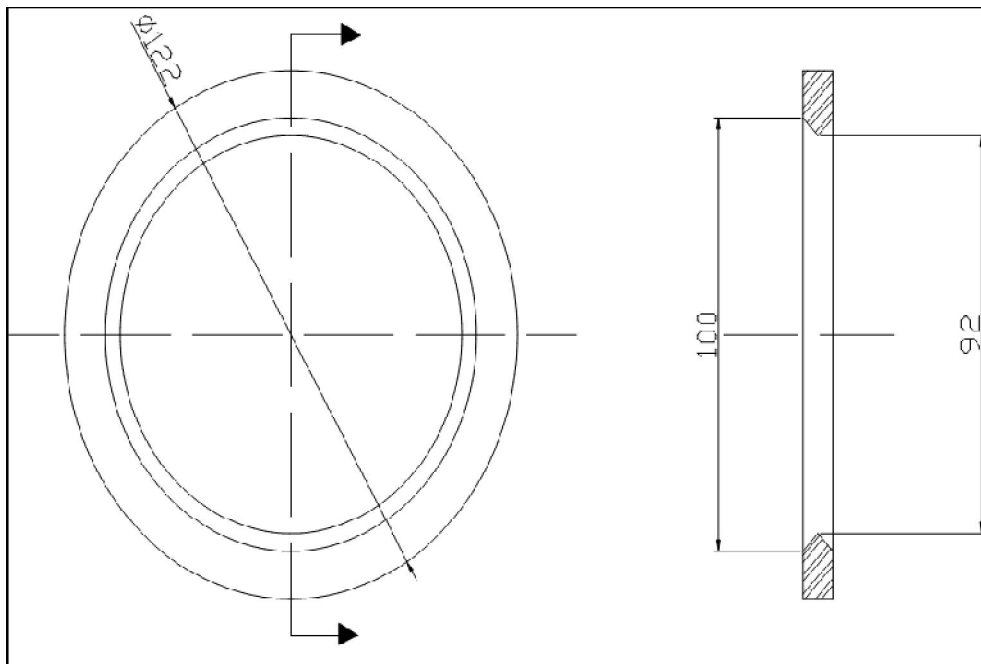

Fig. (2b): Triangle Rib Geometry

# International Journal of Innovative Research in Science, Engineering and Technology

(An ISO 3297: 2007 Certified Organization)

Website: [www.ijirset.com](http://www.ijirset.com)

Vol. 6, Issue 6, June 2017

## III. CALCULATION OF HEAT FLUX

The heat flux of the present work is calculated by means of the cooling water jacket measurements. The inlet and outlet water temperature from each cooling water jacket segment is measured by thermometers and these readings are measured separately for each segment. The cooling water flow rate through each cooling water jacket segment is measured by a digital flow meter. The heat flux at each segment is calculated as follows:

$$q = \frac{\dot{m}_w \cdot C \cdot (T_{out} - T_{in})}{A_{segment}} \quad \text{Equation 1}$$

Where

**q** : Heat flux [ watt/ m<sup>2</sup>].

**$\dot{m}_w$**  : Water mass flow rate, [kg/s].

**C** : Water specific heat capacity, [kJ/kg.C].

**$T_{out}$**  : Water outlet temperature from the cooling segment, [C].

**$T_{in}$**  : Water inlet temperature to the cooling segment, [C].

**$A_{segment}$**  : Cooling water segment surface area, [m<sup>2</sup>].

## IV. EXPERIMENTAL RESULTS AND DISCUSSION

In order to investigate the scope of the current study, which is the influence effect of the annular ribs on combustion characteristics and heat transfer, the measuring devices are connected to measure some parameters such as temperature flame, water inlet temperature, water outlet temperature, water flow and wall surface temperature. After measuring and recording the previous parameters the heat flux is calculated. These previous readings were recorded without using the annular ribs and compared after using the annular ribs (squared and triangular) across the length of the combustion flame tube. All data are plotted related to X/D which is the ratio between the distance of inserting the ribs and the inner diameter of the flame tube.

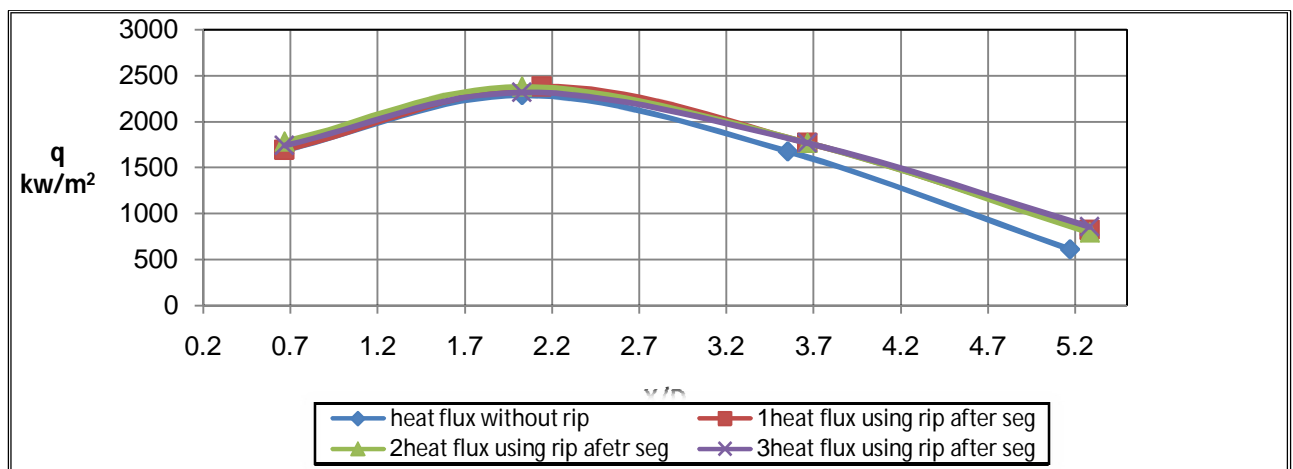

Fig. (3): Effect of axial location of inserting the squared rib on heat flux distribution for lean combustion.

## International Journal of Innovative Research in Science, Engineering and Technology

(An ISO 3297: 2007 Certified Organization)

Website: [www.ijirset.com](http://www.ijirset.com)

Vol. 6, Issue 6, June 2017

Figure (3) presents the effect of the axial location of inserting the squared rib on the heat flux for lean combustion. It is shown that there is an enhancement on heat transfer after inserting the rib and the maximum heat flux is occurred after using rib after segment (2).

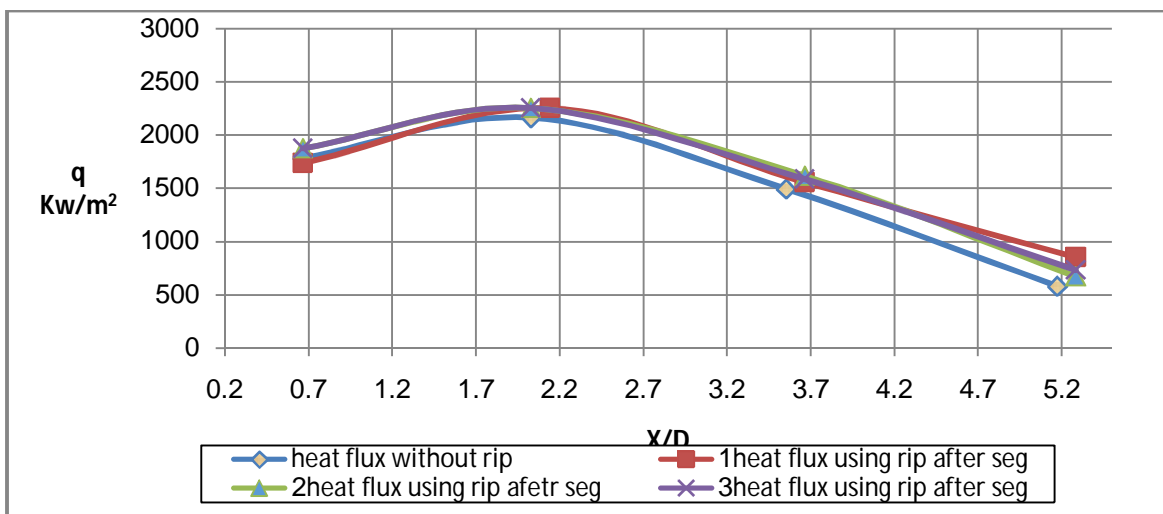

Fig. (4): Effect of axial location of inserting the squared rib on heat flux distribution for rich combustion.

Figure (4) presents the effect of the axial location of inserting the squared rib on the heat flux for rich combustion. It is shown that there is an enhancement on heat transfer after inserting the rib and the maximum heat flux is occurred after using rib after segment (2).

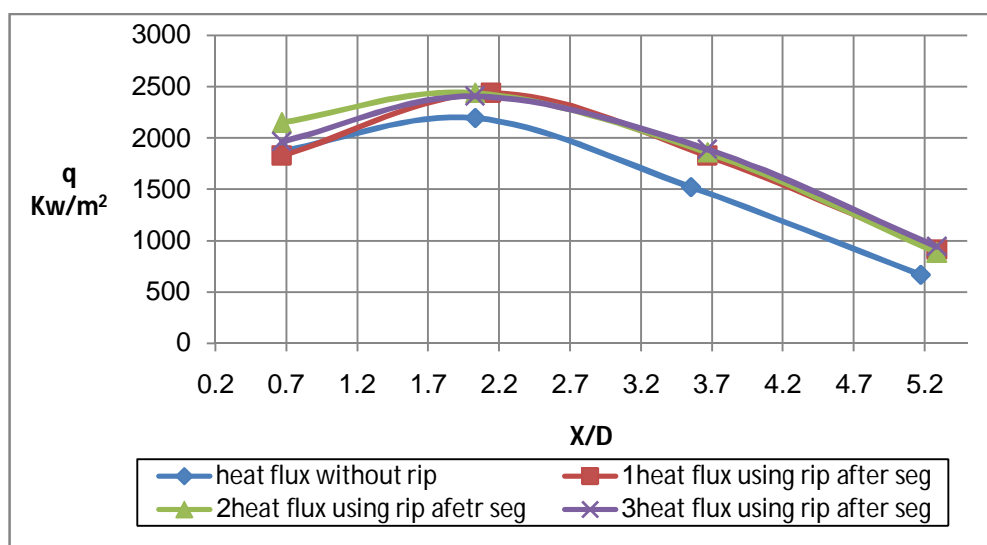

Fig. (5): Effect of axial location of inserting the squared rib on heat flux distribution for stoichiometric combustion.

## International Journal of Innovative Research in Science, Engineering and Technology

(An ISO 3297: 2007 Certified Organization)

Website: [www.ijirset.com](http://www.ijirset.com)

Vol. 6, Issue 6, June 2017

Figure (5) presents the effect of the axial location of inserting the squared rib on the heat flux for stoichiometric combustion. It is shown that there is an enhancement on heat transfer after inserting the rib and the maximum heat flux is occurred after using rib after segment (2).

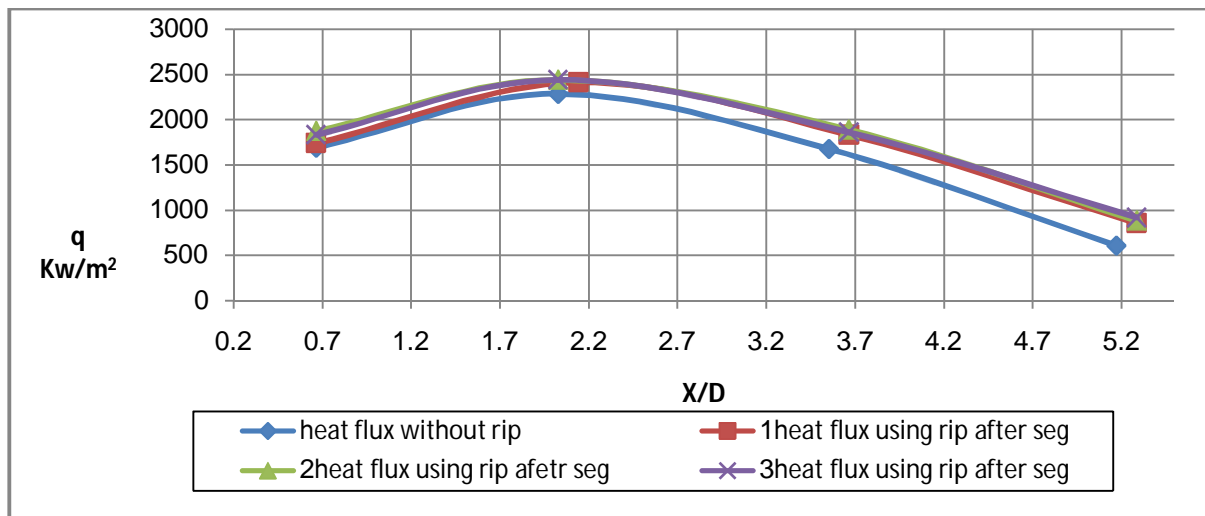

Fig. (6): Effect of axial location of inserting the triangle rib on heat flux distribution for lean combustion.

The relation between the heat flux ( $Kw/m^2$ ) and  $X/D$  which is a dimensionless parameter is plotted at figure (6). The observed increase and enhancement in heat flux is due to inserting the rib. It is crystal clear that the maximum heat flux is occurred after using triangle rib after segment (2).

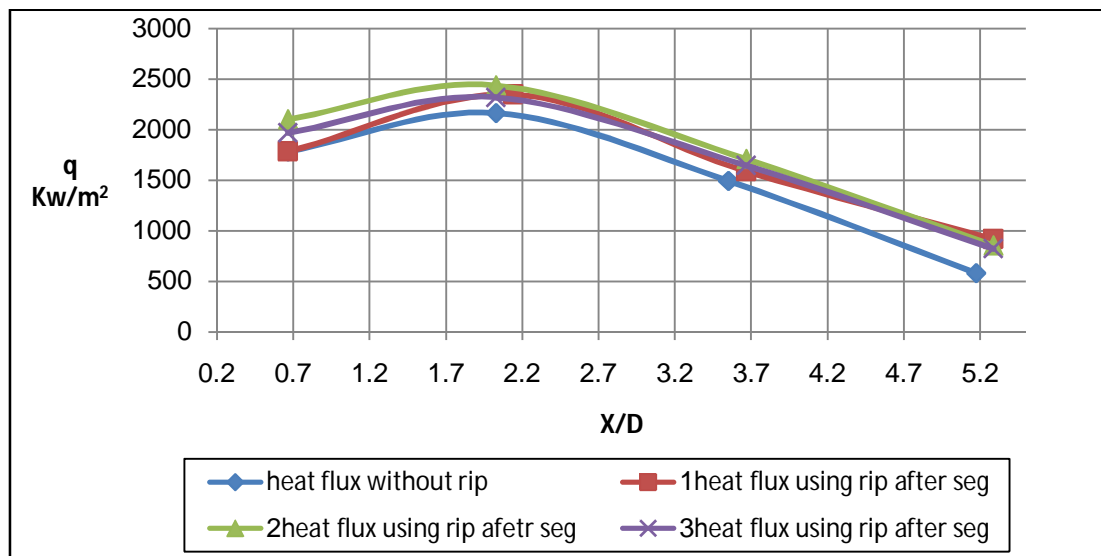

Fig. (7): Effect of axial location of inserting the triangle rib on heat flux distribution for rich combustion.

The relation between the heat flux ( $Kw/m^2$ ) and  $X/D$  which is a dimensionless parameter is plotted at figure (7). The observed increase and enhancement in heat flux is due to inserting the rib. It is crystal clear that the maximum heat flux is occurred after triangle using rib after segment (2).



## International Journal of Innovative Research in Science, Engineering and Technology

(An ISO 3297: 2007 Certified Organization)

Website: [www.ijirset.com](http://www.ijirset.com)

Vol. 6, Issue 6, June 2017

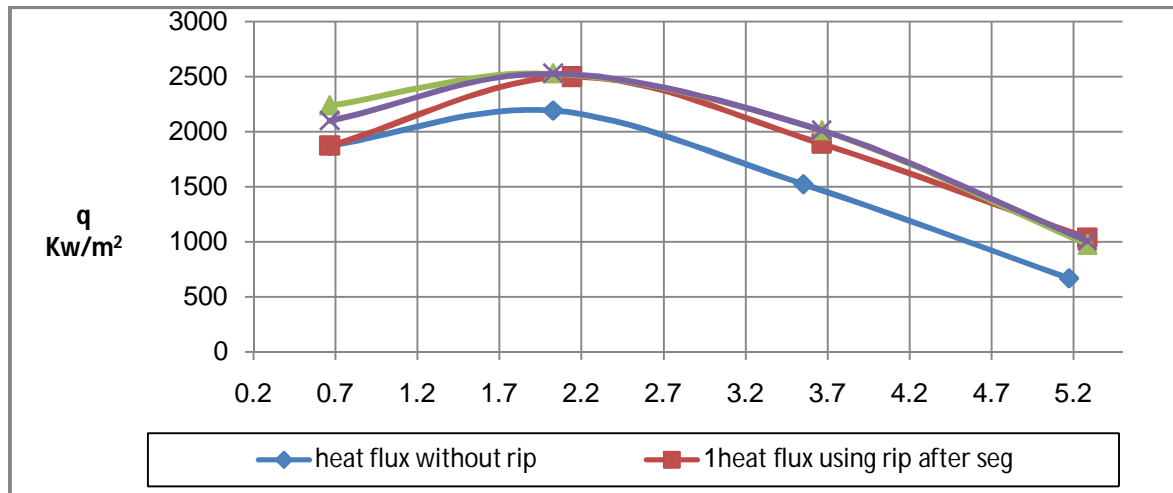

Fig. (8): Effect of axial location of inserting the triangle rib on heat flux distribution for stoichiometric combustion.

The relation between the heat flux (Kw/m<sup>2</sup>) and X/D which is a dimensionless parameter is plotted at figure (8). The observed increase and enhancement in heat flux is due to inserting the rib. It is crystal clear that the maximum heat flux is occurred after using triangle rib after segment (2).

### Comparison between using squared and triangle ribs and its effects on heat transfer

Lean combustion comparison

Inserting ribs after segment (1)

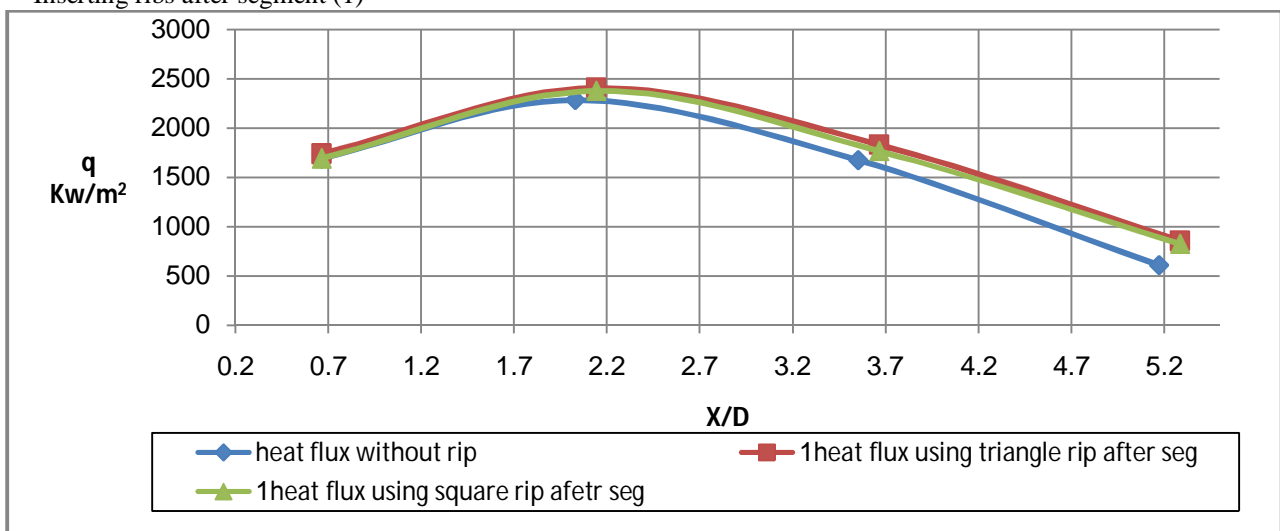

Fig. (9): Comparison between the effect of inserting squared and triangle rib on the heat flux for lean combustion after segment one.

Figure (9) presents the comparison between the effect of inserting squared and triangle rib on the heat flux for lean combustion after segment one. The horizontal axis represents X/D which is a dimensionless parameter and the vertical axis represents the heat flux. It is shown that the effect of triangle ribs on the heat flux is greater than the effect of the squared one.



## International Journal of Innovative Research in Science, Engineering and Technology

(An ISO 3297: 2007 Certified Organization)

Website: [www.ijirset.com](http://www.ijirset.com)

Vol. 6, Issue 6, June 2017

Inserting rib after segment (2)

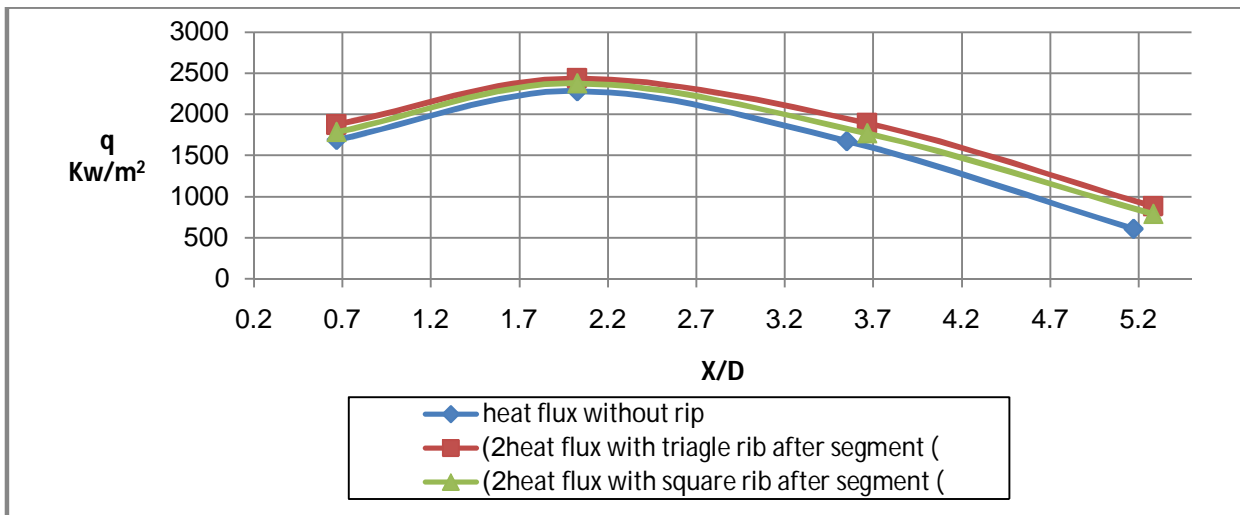

Fig.(10): Comparison between the effect of inserting squared and triangle rib on the heat flux for lean combustion after segment two.

Figure (10) presents the comparison between the effect of inserting squared and triangle rib on the heat flux for lean combustion after segment two. The horizontal axis represents X/D which is a dimensionless parameter and the vertical axis represents the heat flux. It is shown that the effect of triangle ribs on the heat flux is greater than the effect of the squared one.

INSERTING RIB AFTER SEGMENT (3)

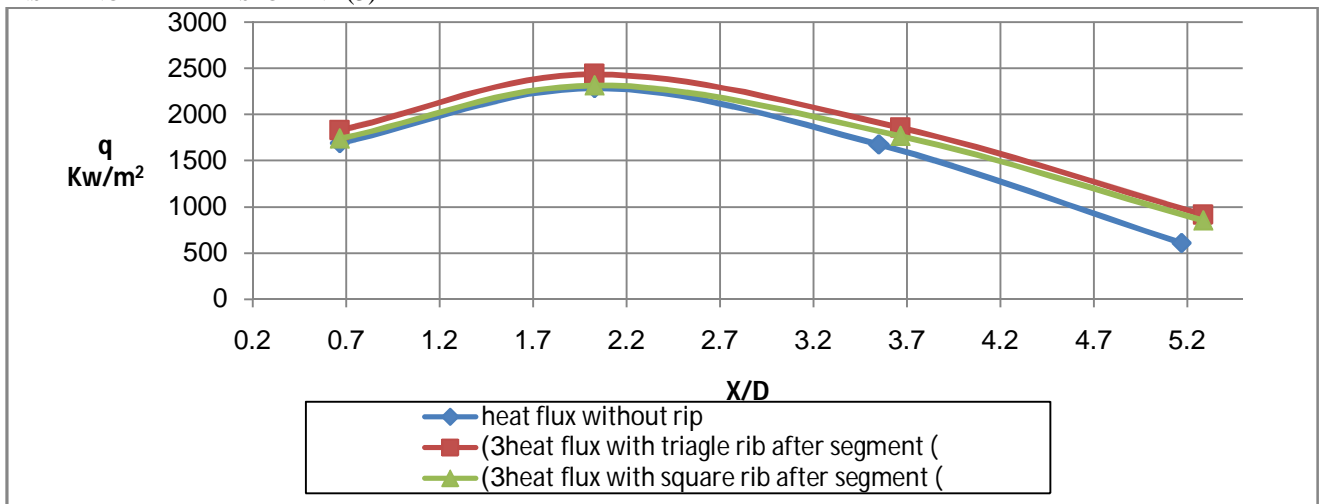

FIG. (11): Comparison between the effect of inserting squared and triangle rib on the heat flux for lean combustion after segment three.

Figure (11) presents the comparison between the effect of inserting squared and triangle rib on the heat flux for lean combustion after segment three. The horizontal axis represents X/D which is a dimensionless parameter and the vertical axis represents the heat flux. It is shown that the effect of triangle ribs on the heat flux is greater than the effect of the squared one.

# International Journal of Innovative Research in Science, Engineering and Technology

(An ISO 3297: 2007 Certified Organization)

Website: [www.ijirset.com](http://www.ijirset.com)

Vol. 6, Issue 6, June 2017

RICH COMBUSTION COMPARISON  
INSERTING RIB AFTER SEGMENT (1)

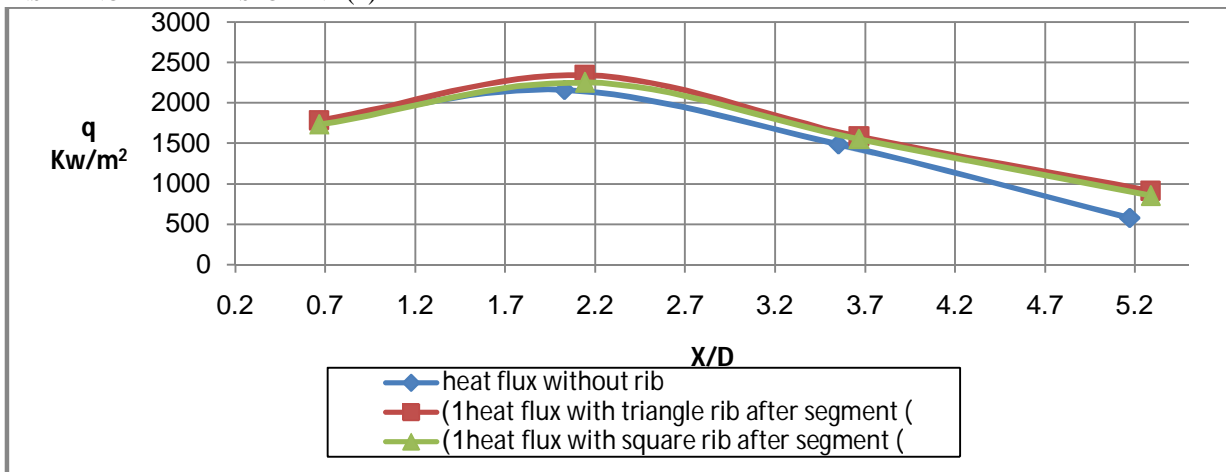

FIG. (12): Comparison between the effect of inserting squared and triangle rib on the heat flux for rich combustion after segment one.

Figure (12) presents the comparison between the effect of inserting squared and triangle rib on the heat flux for Rich combustion after segment one. The horizontal axis represents X/D which is a dimensionless parameter and the vertical axis represents the heat flux. It is shown that the effect of triangle ribs on the heat flux is greater than the effect of the squared one.

INSERTING RIB AFTER SEGMENT (2)

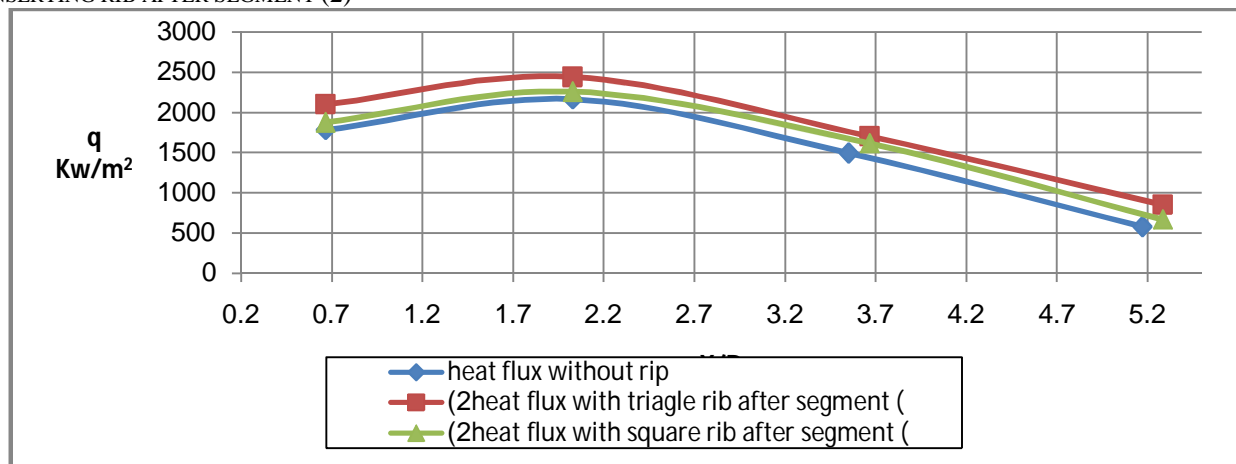

FIG. (13): Comparison between the effect of inserting squared and triangle rib on the heat flux for rich combustion after segment two.

Figure (13) presents the comparison between the effect of inserting squared and triangle rib on the heat flux for Rich combustion after segment two. The horizontal axis represents X/D which is a dimensionless parameter and the vertical axis represents the heat flux. It is shown that the effect of triangle ribs on the heat flux is greater than the effect of the squared one.

# International Journal of Innovative Research in Science, Engineering and Technology

(An ISO 3297: 2007 Certified Organization)

Website: [www.ijirset.com](http://www.ijirset.com)

Vol. 6, Issue 6, June 2017

## INSERTING RIB AFTER SEGMENT (3)

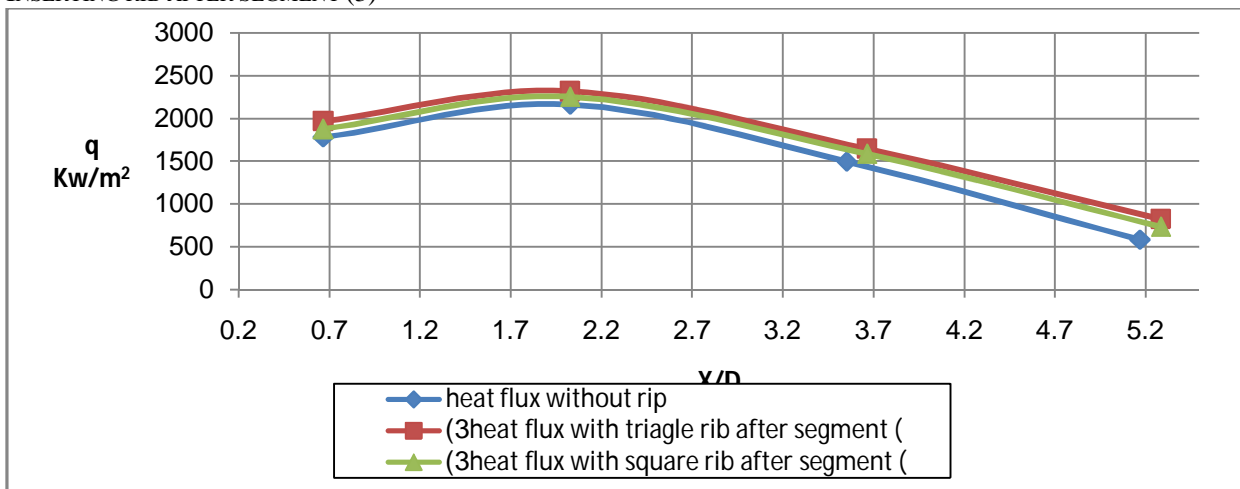

FIG. (14): Comparison between the effect of inserting squared and triangle rib on the heat flux for Rich combustion after segment three.

Figure (14) presents the comparison between the effect of inserting squared and triangle rib on the heat flux for Rich combustion after segment three. The horizontal axis represents X/D which is a dimensionless parameter and the vertical axis represents the heat flux. It is shown that the effect of triangle ribs on the heat flux is greater than the effect of the squared one.

## STOICHIOMETRIC COMBUSTION COMPARISON

### INSERTING RIB AFTER SEGMENT (1)

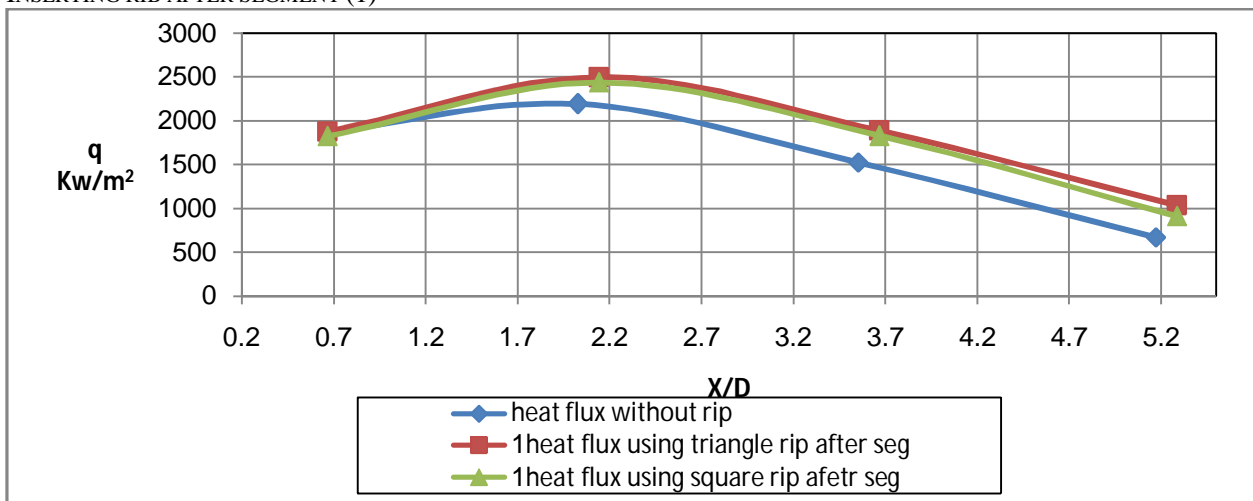

FIG. (15): Comparison between the effect of inserting squared and triangle rib on the heat flux for stoichiometric combustion after segment one.

Figure (15) presents the comparison between the effect of inserting squared and triangle rib on the heat flux for stoichiometric combustion after segment one. The horizontal axis represents X/D which is a dimensionless parameter and the vertical axis represents the heat flux. It is shown that the effect of triangle ribs on the heat flux is greater than the effect of the squared one.

Inserting rib after segment (2)

## International Journal of Innovative Research in Science, Engineering and Technology

(An ISO 3297: 2007 Certified Organization)

Website: [www.ijirset.com](http://www.ijirset.com)

Vol. 6, Issue 6, June 2017

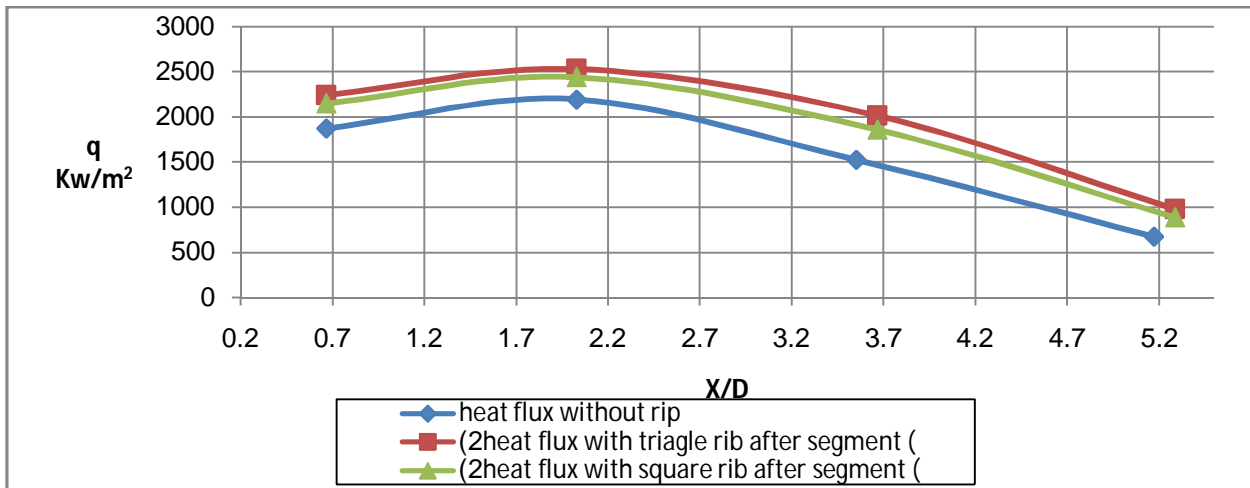

FIG. (16): Comparison between the effect of inserting squared and triangle rib on the heat flux for stoichiometric combustion after segment two.

Figure (16) presents the comparison between the effect of inserting squared and triangle rib on the heat flux for stoichiometric combustion after segment two. The horizontal axis represents X/D which is a dimensionless parameter and the vertical axis represents the heat flux. It is shown that the effect of triangle ribs on the heat flux is greater than the effect of the squared one.

### INSERTING RIB AFTER SEGMENT (3)

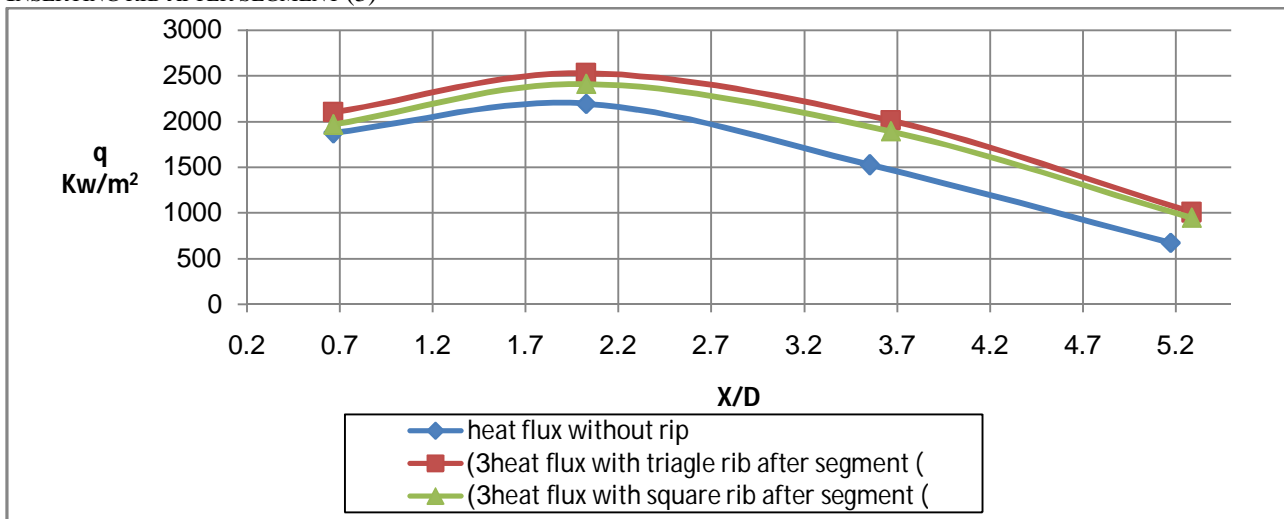

FIG. (17): Comparison between the effect of inserting squared and triangle rib on the heat flux for stoichiometric combustion after segment three.

Figure (17) presents the comparison between the effect of inserting squared and triangle rib on the heat flux for stoichiometric combustion after segment three. The horizontal axis represents X/D which is a dimensionless parameter and the vertical axis represents the heat flux. It is shown that the effect of triangle ribs on the heat flux is greater than the effect of the squared one.

# International Journal of Innovative Research in Science, Engineering and Technology

(An ISO 3297: 2007 Certified Organization)

Website: [www.ijirset.com](http://www.ijirset.com)

Vol. 6, Issue 6, June 2017

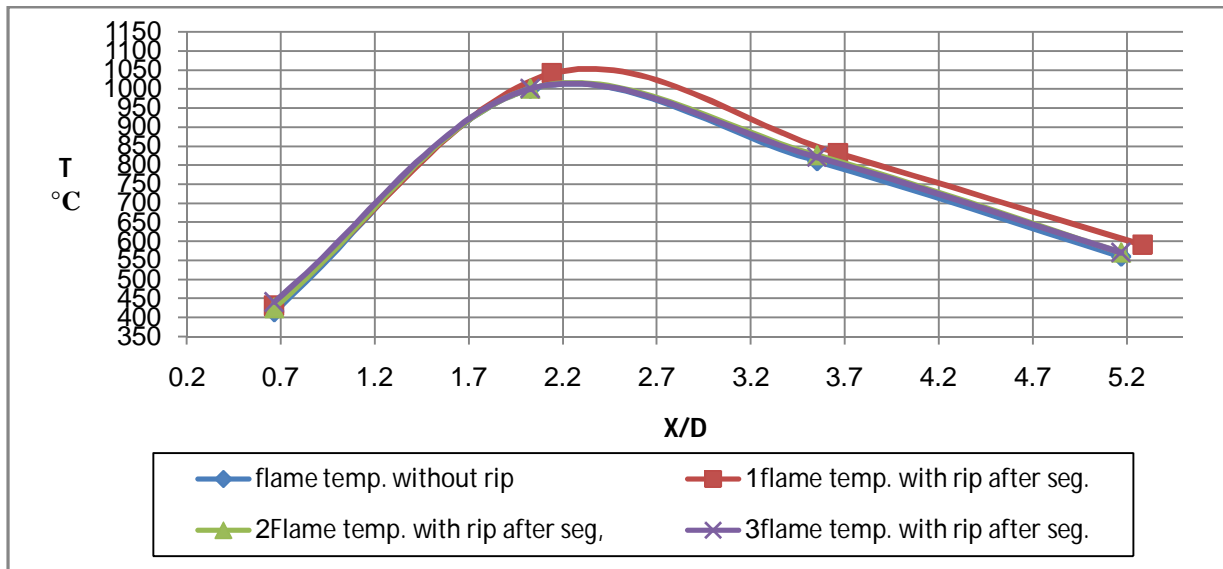

FIG. (18): Effect of axial location of inserting the squared rib on the flame temperature for lean combustion.

Figure (18) presents the effect of the axial location of inserting the squared rib on the flame temperature for lean combustion. It is shown that there is an enhancement on heat transfer after inserting the rib and the maximum heat flux is occurred after using rib after segment (2).

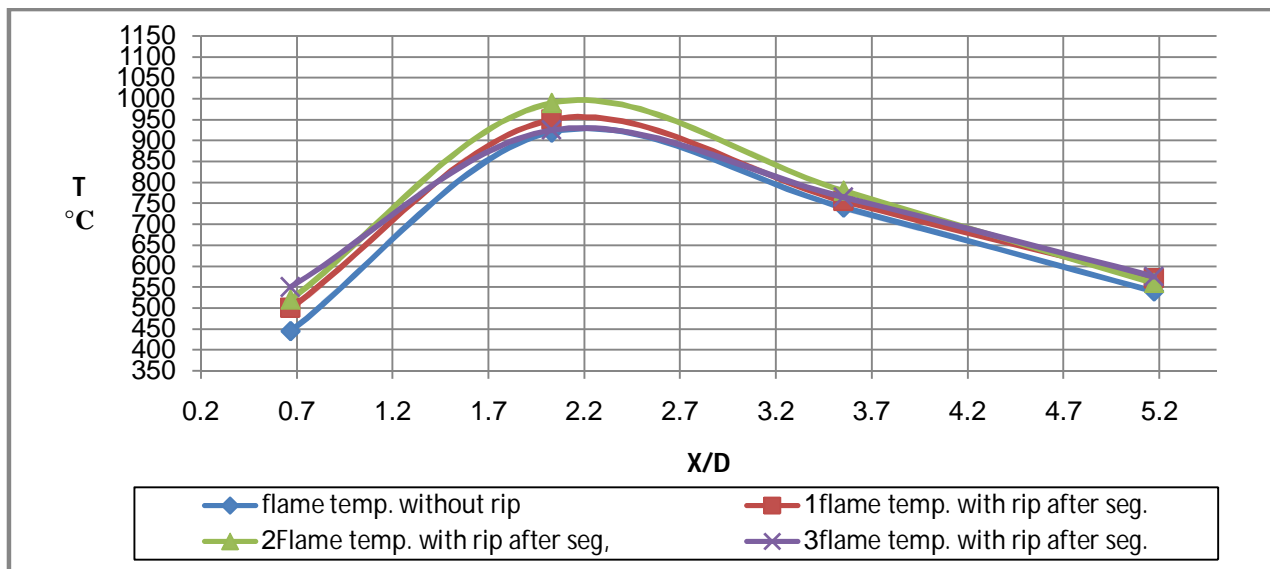

FIG. (19): Effect of axial location of inserting the squared rib on the flame temperature for rich combustion.

Figure (19) presents the effect of the axial location of inserting the squared rib on the flame temperature for rich combustion. It is shown that there is an enhancement on heat transfer after inserting the rib and the maximum heat flux is occurred after using rib after segment (2).

## International Journal of Innovative Research in Science, Engineering and Technology

(An ISO 3297: 2007 Certified Organization)

Website: [www.ijirset.com](http://www.ijirset.com)

Vol. 6, Issue 6, June 2017

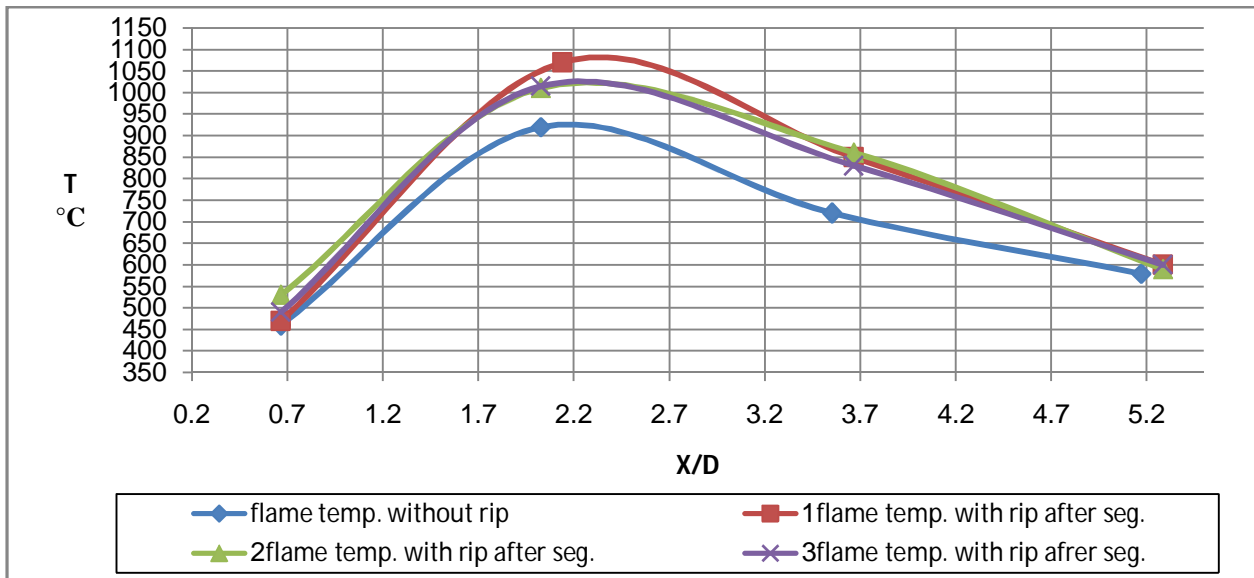

FIG. (20): Effect of axial location of inserting the squared rib on the flame temperature for stoichiometric combustion.

Figure (20) presents the effect of the axial location of inserting the squared rib on the flame temperature for stoichiometric combustion. It is shown that there is an enhancement on heat transfer after inserting the rib and the maximum heat flux is occurred after using rib after segment (2).

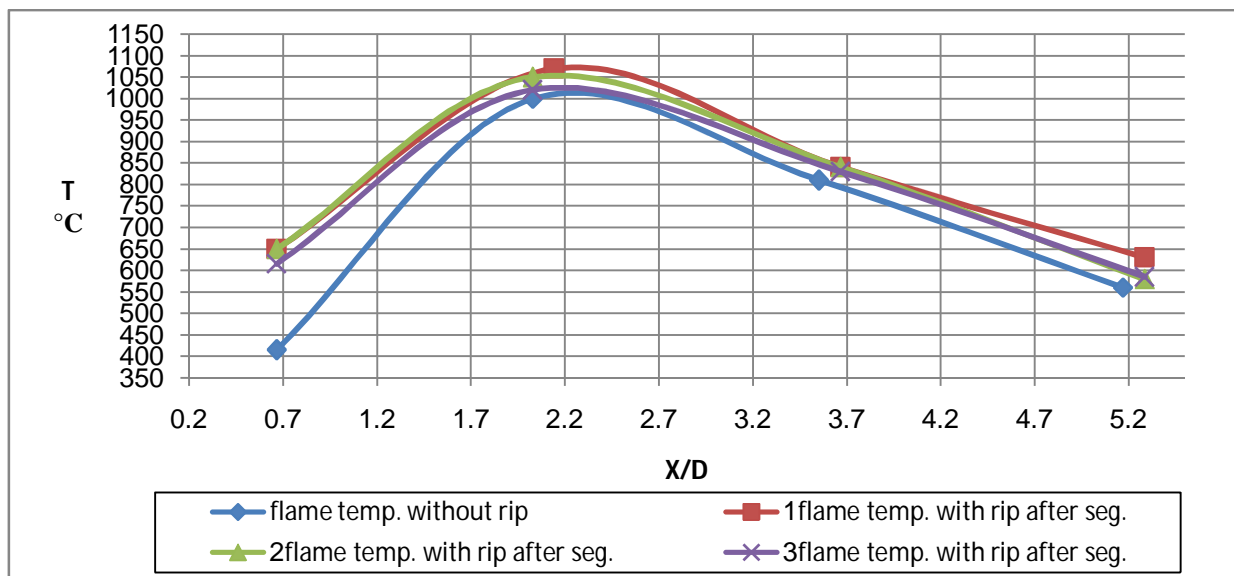

FIG. (21): Effect of axial location of inserting the triangle rib on the flame temperature for lean combustion.

Figure (21) presents the effect of the axial location of inserting the squared rib on the flame temperature for lean combustion. It is shown that there is an enhancement on heat transfer after inserting the rib and the maximum heat flux is occurred after using rib after segment (2).

## International Journal of Innovative Research in Science, Engineering and Technology

(An ISO 3297: 2007 Certified Organization)

Website: [www.ijirset.com](http://www.ijirset.com)

Vol. 6, Issue 6, June 2017

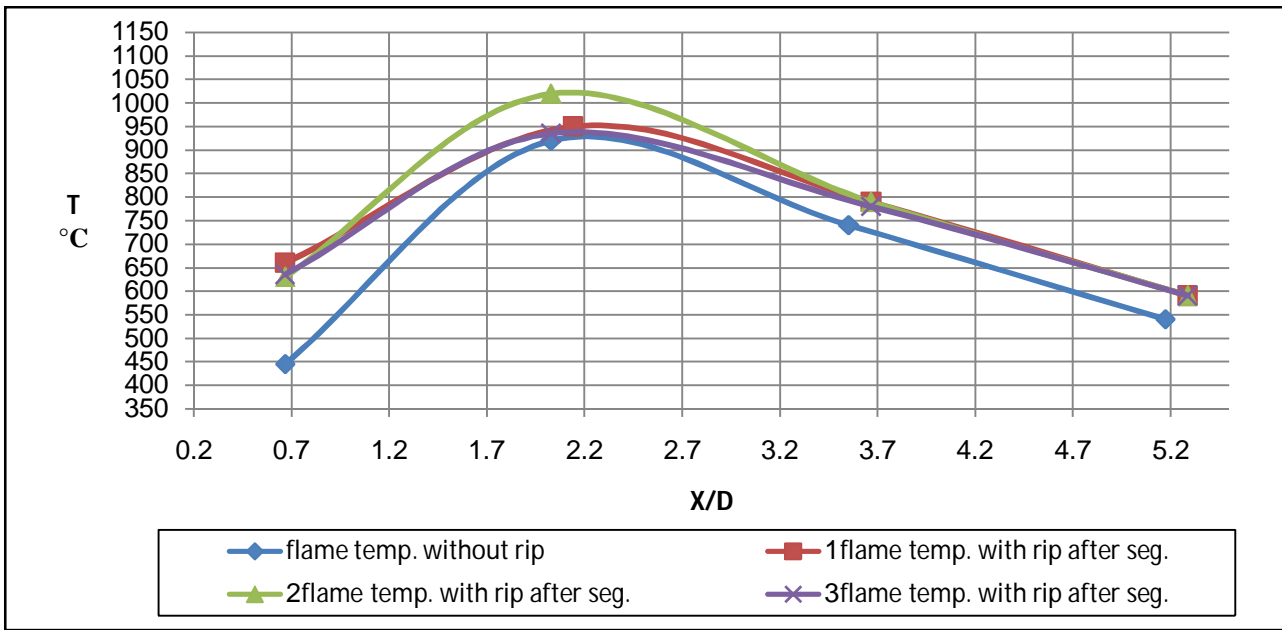

FIG. (22): Effect of axial location of inserting the triangle rib on the flame temperature for rich combustion.

Figure (22) presents the effect of the axial location of inserting the squared rib on the flame temperature for rich combustion. It is shown that there is an enhancement on heat transfer after inserting the rib and the maximum heat flux is occurred after using rib after segment (2).

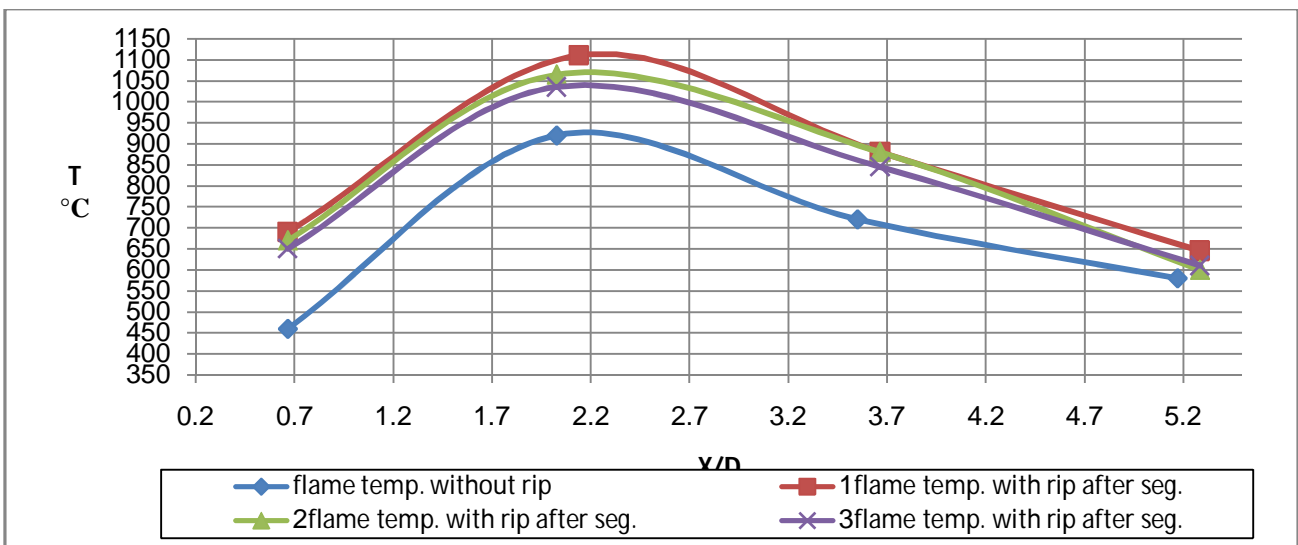

FIG. (23): Effect of axial location of inserting the triangle rib on the flame temperature for stoichiometric combustion.

Figure (23) presents the effect of the axial location of inserting the squared rib on the flame temperature forstoichiometric combustion. It is shown that there is an enhancement on heat transfer after inserting the rib and the maximum heat flux is occurred after using rib after segment (2).



## COMPARISON BETWEEN USING SQUARED AND TRIANGLE RIBS AND ITS EFFECTS ON FLAME TEMPERATURE

LEAN COMBUSTION COMPARISON  
INSERTING RIBS AFTER SEGMENT (1)

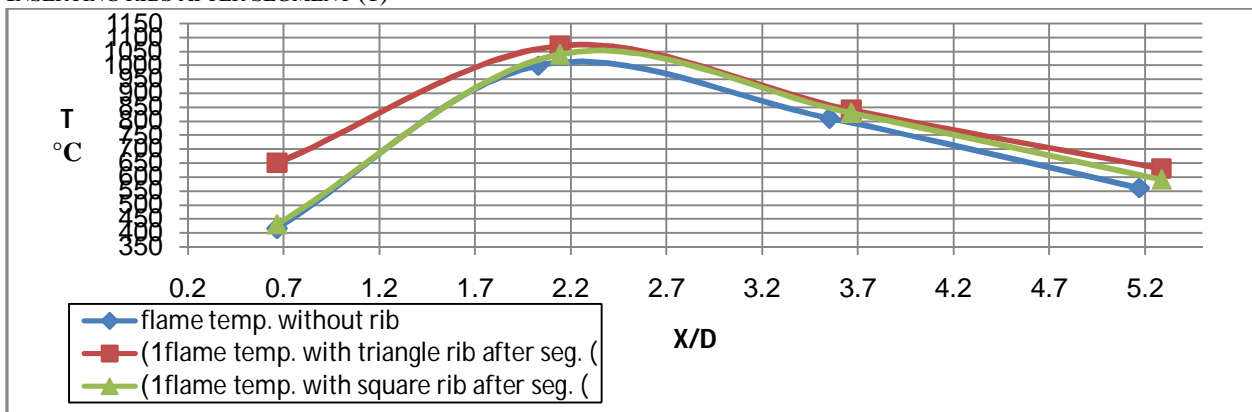

Fig. (24): Comparison between the effect of inserting squared and triangle rib on the flame temperature for lean combustion after segment one.

Figure (24) presents the comparison between the effect of inserting squared and triangle rib on the Flame temperature for lean combustion after segment one. The horizontal axis represents X/D which is a dimensionless parameter and the vertical axis represents the flame temperature. It is shown that the effect of triangle ribs on the flame temperature is greater than the effect of the squared.

Inserting rib after segment (2)

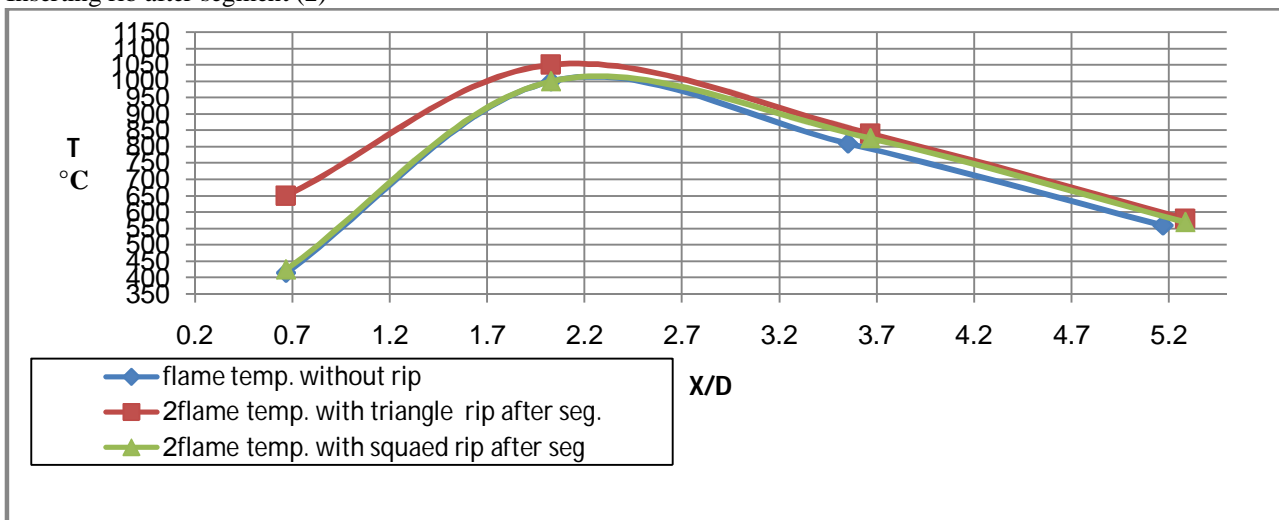

FIG.(25): Comparison between the effect of inserting squared and triangle rib on the flame temperature for lean combustion after segment two.

Figure (25) presents the comparison between the effect of inserting squared and triangle rib on the Flame temperature for lean combustion after segment two. The horizontal axis represents X/D which is a dimensionless parameter and the vertical axis represents the flame temperature. It is shown that the effect of triangle ribs on the flame temperature is greater than the effect of the squared.

# International Journal of Innovative Research in Science, Engineering and Technology

(An ISO 3297: 2007 Certified Organization)

Website: [www.ijirset.com](http://www.ijirset.com)

Vol. 6, Issue 6, June 2017

INSERTING RIB AFTER SEGMENT (3)

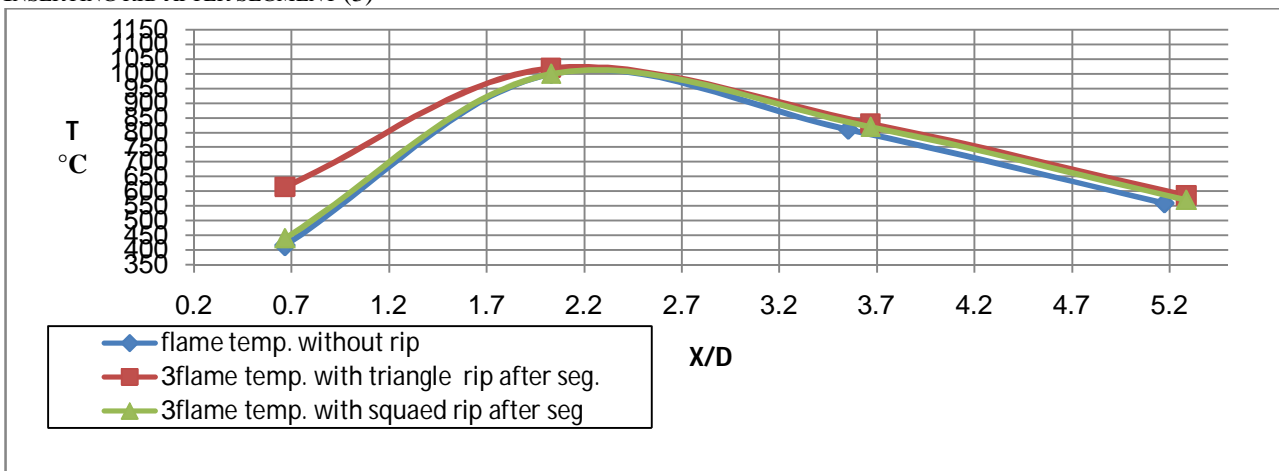

FIG. (26): Comparison between the effect of inserting squared and triangle rib on the flame temperature for lean combustion after segment three.

Figure (26) presents the comparison between the effect of inserting squared and triangle rib on the Flame temperature for lean combustion after segment three. The horizontal axis represents X/D which is a dimensionless parameter and the vertical axis represents the flame temperature. It is shown that the effect of triangle ribs on the flame temperature is greater than the effect of the squared

.RICH COMBUSTION COMPARISON  
INSERTING RIB AFTER SEGMENT (1)

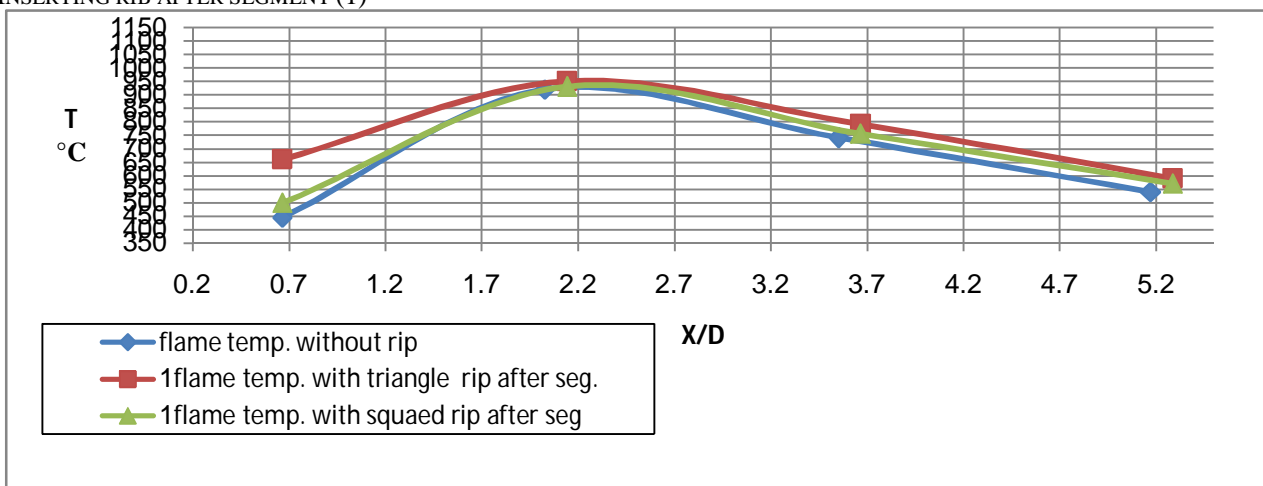

FIG. (27): Comparison between the effect of inserting squared and triangle rib on the flame temperature for rich combustion after segment one.

Figure (27) presents the comparison between the effect of inserting squared and triangle rib on the Flame temperature for rich combustion after segment one. The horizontal axis represents X/D which is a dimensionless parameter and the vertical axis represents the flame temperature. It is shown that the effect of triangle ribs on the flame temperature is greater than the effect of the squared

# International Journal of Innovative Research in Science, Engineering and Technology

(An ISO 3297: 2007 Certified Organization)

Website: [www.ijirset.com](http://www.ijirset.com)

Vol. 6, Issue 6, June 2017

Inserting rib after segment (2)

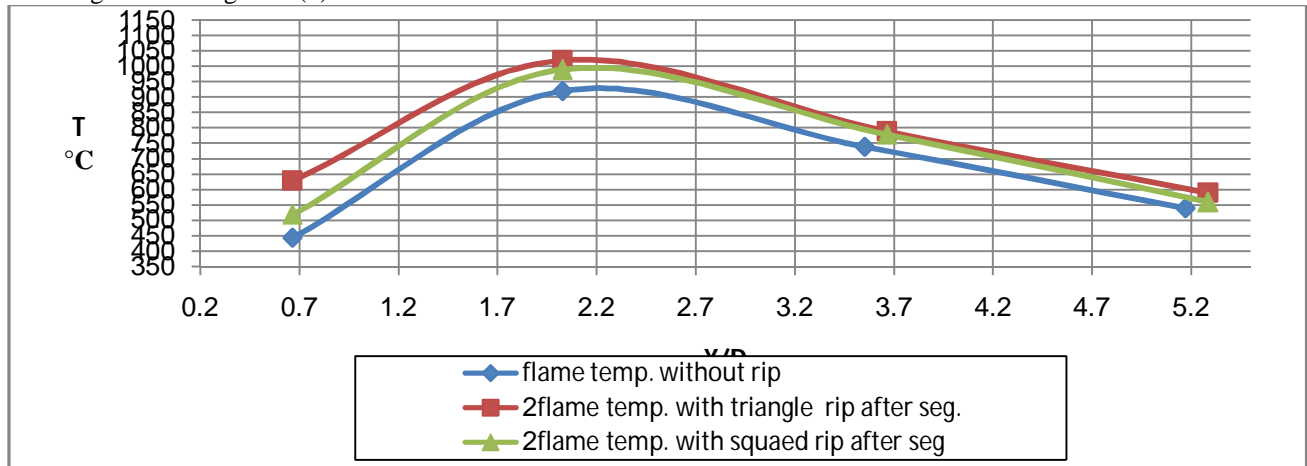

FIG. ERROR! NO TEXT OF SPECIFIED STYLE IN DOCUMENT.(28): Comparison between the effect of inserting squared and triangle rib on the flame temperature for rich combustion after segment two.

Figure (28) presents the comparison between the effect of inserting squared and triangle rib on the Flame temperature for rich combustion after segment two. The horizontal axis represents X/D which is a dimensionless parameter and the vertical axis represents the flame temperature. It is shown that the effect of triangle ribs on the flame temperature is greater than the effect of the squared

INSERTING RIB AFTER SEGMENT (3)

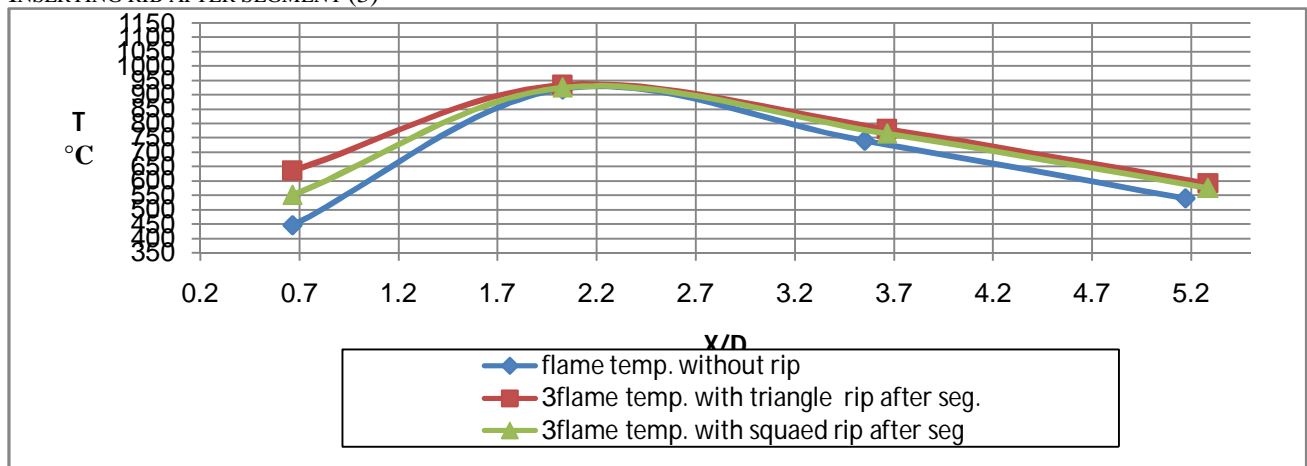

Fig. (29): Comparison between the effect of inserting squared and triangle rib on the flame temperature for rich combustion after segment three.

Figure (26) presents the comparison between the effect of inserting squared and triangle rib on the Flame temperature for rich combustion after segment three. The horizontal axis represents X/D which is a dimensionless parameter and the vertical axis represents the flame temperature. It is shown that the effect of triangle ribs on the flame temperature is greater than the effect of the squared

# International Journal of Innovative Research in Science, Engineering and Technology

(An ISO 3297: 2007 Certified Organization)

Website: [www.ijirset.com](http://www.ijirset.com)

Vol. 6, Issue 6, June 2017

## STOICHIOMETRIC COMBUSTION COMPARISON INSERTING RIB AFTER SEGMENT (1)

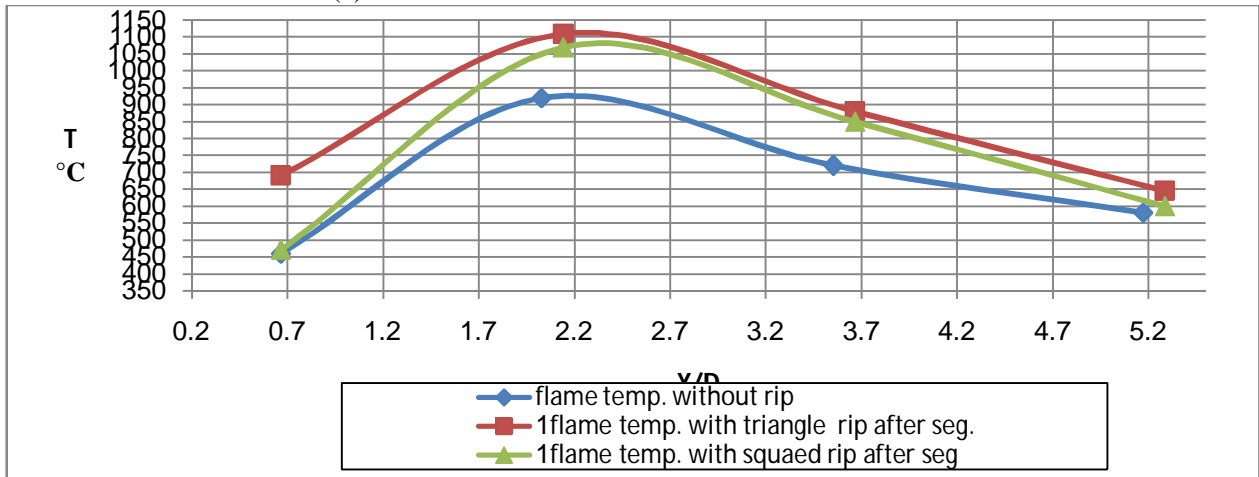

FIG. (30): Comparison between the effect of inserting squared and triangle rib on the flame temperature for stoichiometric combustion after segment one.

Figure (30) presents the comparison between the effect of inserting squared and triangle rib on the Flame temperature for stoichiometric combustion after segment one. The horizontal axis represents X/D which is a dimensionless parameter and the vertical axis represents the flame temperature. It is shown that the effect of triangle ribs on the flame temperature is greater than the effect of the squared

## INSERTING RIB AFTER SEGMENT (2)

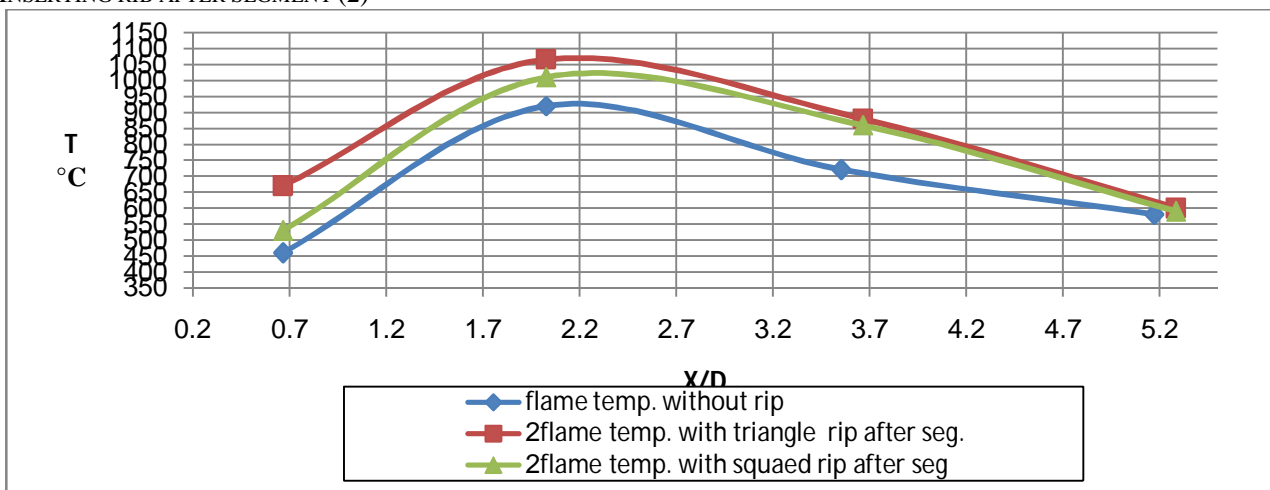

FIG. (31): Comparison between the effect of inserting squared and triangle rib on the flame temperature for stoichiometric combustion after segment two.

Figure (31) presents the comparison between the effect of inserting squared and triangle rib on the Flame temperature for stoichiometric combustion after segment two. The horizontal axis represents X/D which is a dimensionless parameter and the vertical axis represents the flame temperature. It is shown that the effect of triangle ribs on the flame temperature is greater than the effect of the squared

## INSERTING RIB AFTER SEGMENT (3)

# International Journal of Innovative Research in Science, Engineering and Technology

(An ISO 3297: 2007 Certified Organization)

Website: [www.ijirset.com](http://www.ijirset.com)

Vol. 6, Issue 6, June 2017

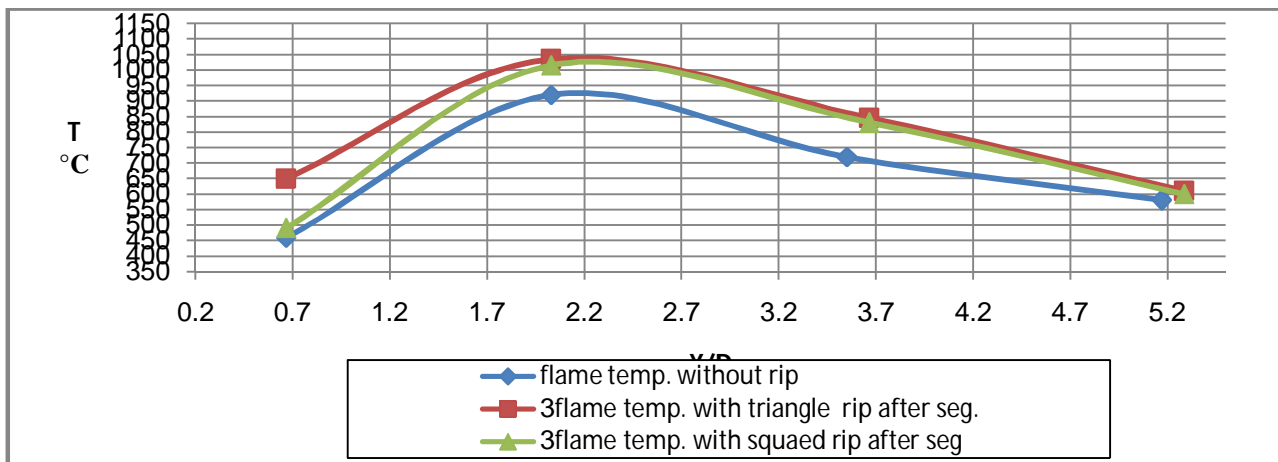

FIG. (32): Comparison between the effect of inserting squared and triangle rib on the flame temperature for stoichiometric combustion after segment three.

Figure (32) presents the comparison between the effect of inserting squared and triangle rib on the Flame temperature for stoichiometric combustion after segment three. The horizontal axis represents X/D which is a dimensionless parameter and the vertical axis represents the flame temperature. It is shown that the effect of triangle ribs on the flame temperature is greater than the effect of the squared

It is crystal clear that the effect of using the triangle rib on the combustion characteristics and heat transfer is better than using the square one. And this because of swirl motion and eddies created due to generation of swirl. This swirl motion is produced after using the triangular rib. This kind of motion gradually enhances the combustion characteristics and heat transfer. Also the flame is stabilized by a swirling flow formed after inserting the triangle rib.

### Gas Analysis:

#### Lean combustion comparison:

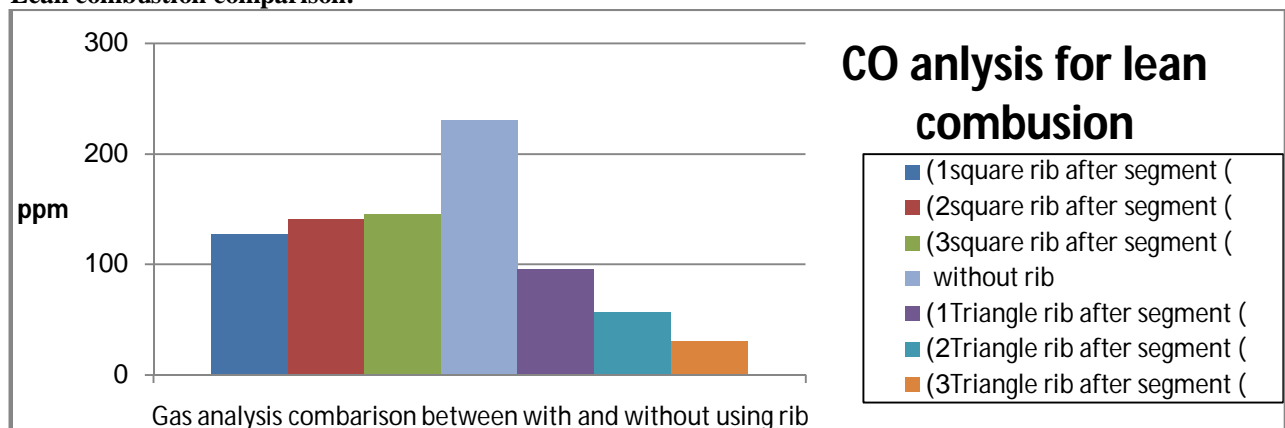

Fig. (33): Comparison between the effect of inserting squared and triangle rib CO analysis for lean combustion.

Figure (33) presents the comparison between the effect of inserting squared and triangle rib CO analysis for lean combustion. It is shown that the percentage of CO with using square rib is greater than with using triangle rib.

## International Journal of Innovative Research in Science, Engineering and Technology

(An ISO 3297: 2007 Certified Organization)

Website: [www.ijirset.com](http://www.ijirset.com)

Vol. 6, Issue 6, June 2017

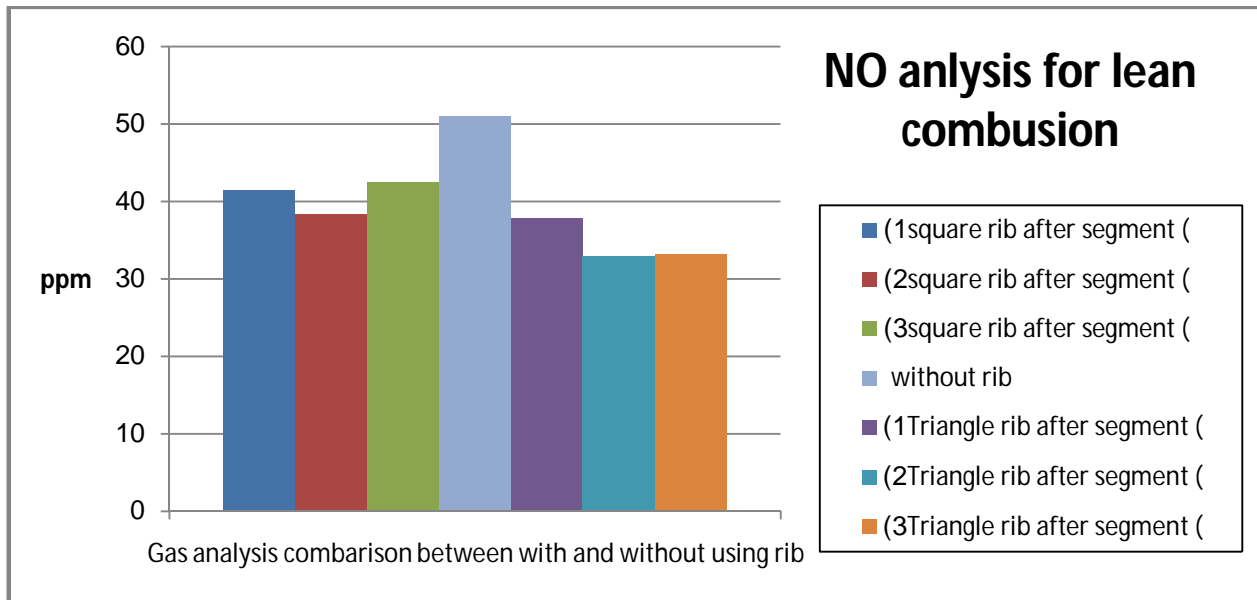

Fig. (34): Comparison between the effect of inserting squared and triangle rib NO analysis for lean combustion.

Figure (34) presents the comparison between the effect of inserting squared and triangle rib NO analysis for lean combustion. It is shown that the percentage of NO with using square rib is greater than with using triangle rib.

### Rich combustion comparison:

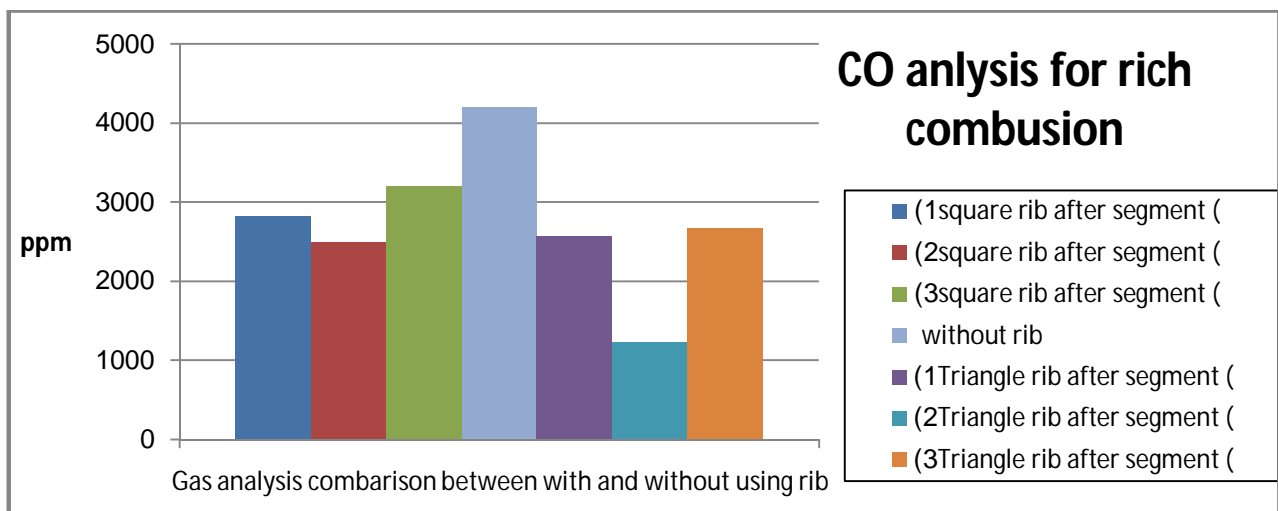

Fig. (35): Comparison between the effect of inserting squared and triangle rib CO analysis for rich combustion.

Figure (35) presents the comparison between the effect of inserting squared and triangle rib CO analysis for rich combustion. It is shown that the percentage of CO with using square rib is greater than with using triangle rib.

## International Journal of Innovative Research in Science, Engineering and Technology

(An ISO 3297: 2007 Certified Organization)

Website: [www.ijirset.com](http://www.ijirset.com)

Vol. 6, Issue 6, June 2017

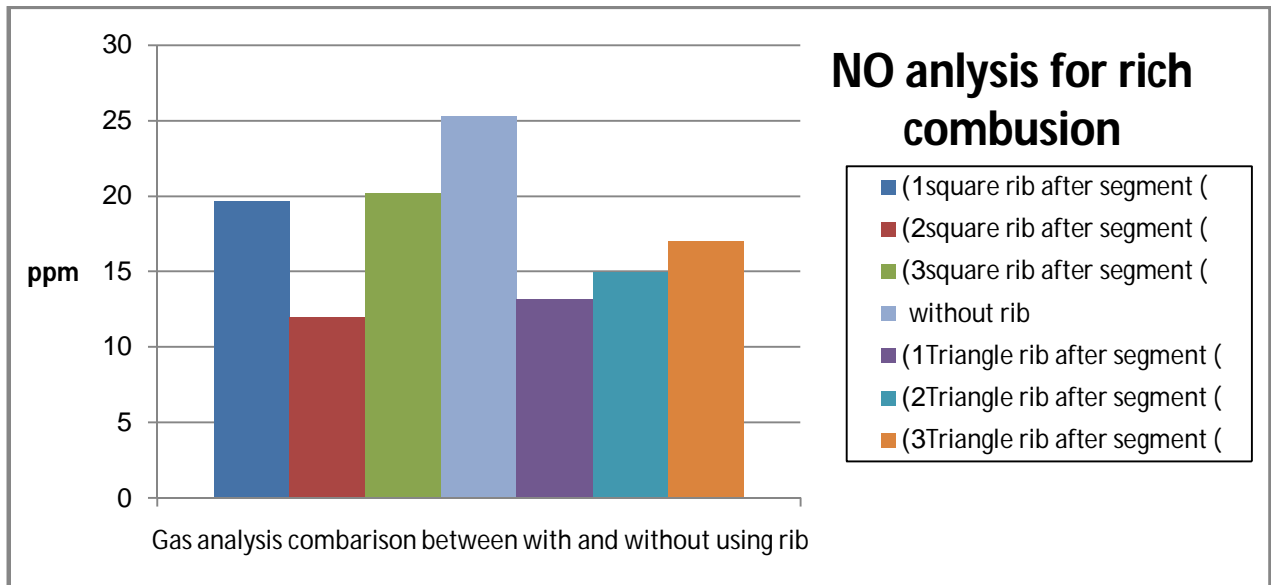

Fig. (36): Comparison between the effect of inserting squared and triangle rib NO analysis for rich combustion.

Figure (36) presents the comparison between the effect of inserting squared and triangle rib NO analysis for rich combustion. It is shown that the percentage of NO with using square rib is greater than with using triangle rib.

### Stoichiometric combustion comparison:

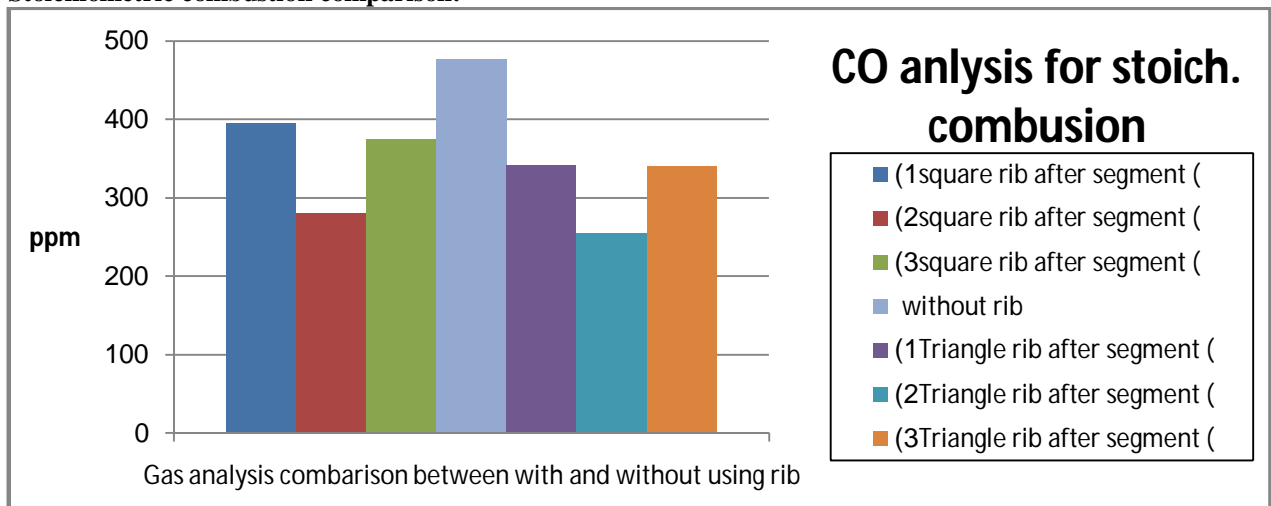

Fig. (37): Comparison between the effect of inserting squared and triangle rib CO analysis for Stoichiometric combustion.

Figure (37) presents the comparison between the effect of inserting squared and triangle rib CO analysis for stoichiometric combustion. It is shown that the percentage of CO with using square rib is greater than with using triangle rib.



## International Journal of Innovative Research in Science, Engineering and Technology

(An ISO 3297: 2007 Certified Organization)

Website: [www.ijirset.com](http://www.ijirset.com)

Vol. 6, Issue 6, June 2017

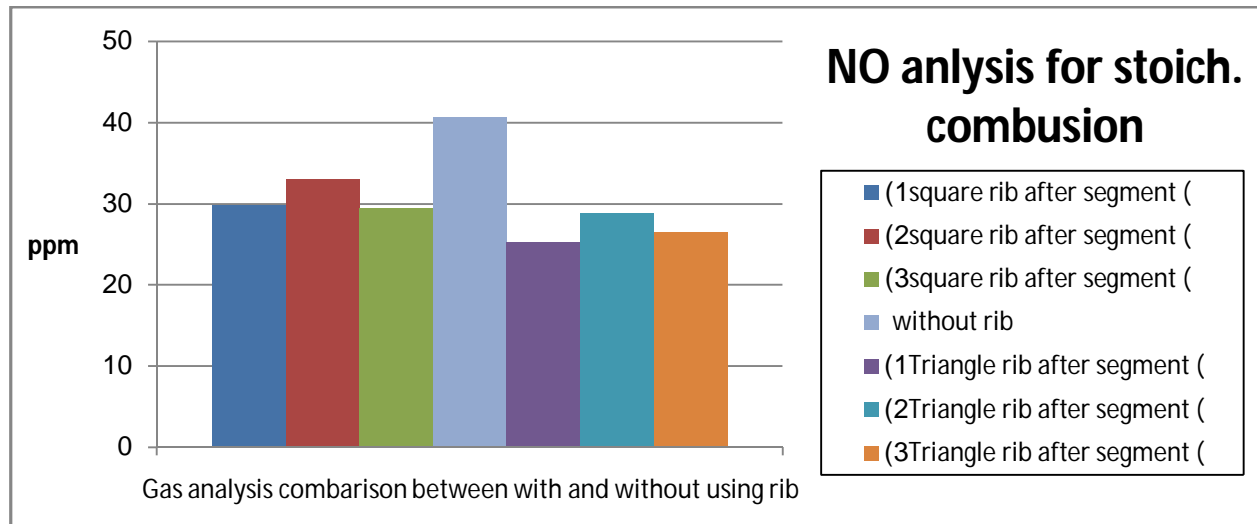

Fig. (38): Comparison between the effect of inserting squared and triangle rib NO analysis for Stoichiometric combustion.

Figure (33) presents the comparison between the effect of inserting squared and triangle rib NO analysis for stoichiometric combustion. It is shown that the percentage of NO with using square rib is greater than with using triangle rib.

### V. CONCLUSIONS

The annular rib insertion has shown beneficial and significant effect on heat transfer, combustion characteristics and gas analysis across a longitudinal flame tube using a premixed flame burner over similar combustion without rib insertion. The major conclusions that found from the present study are as follows:-

- The annular ribs increase the heat transfer rate across the chamber walls.
- There is a significant enhancement on the flame and surface temperatures due to using ribs.
- For stoichiometric combustion, the maximum heat flux, flame temperature and surface temperature are found.
- At the insertion point of the rib ( $X/D = 2.029$ ), each of maximum surface temperature, flame temperature and maximum heat transfer rate are found.
- The effect of the triangle rib is greater than the effect of the squared one on the heat flux and the flame temperature.
- The lowest emission of CO is occurred for lean combustion after inserting the triangle rib at ( $X/D = 3.667$ ).
- The lowest emission of NO is occurred for rich combustion after inserting the triangle rib at ( $X/D = 2.029$ ).

### REFERENCES

- [1] Ali Najah Al-Shamani, K. Sopian, H. A. Mohammed and Sohif Mat, Enhancement heat transfer characteristics in the channel with trapezoidal rib-groove using Nano fluids (2015).
- [2] Bodade, Pradip Ramdas, A study on the heat transfer enhancement for air flow through a duct with various ribs inserts (2013).
- [3] Caliskan, Flow and heat transfer characteristics of transverse perforated ribs under impingement jets (2013).
- [4] S. Caliskan, S. Baskaya, Velocity field and turbulence effects on heat transfer characteristics from surfaces with V-shaped ribs, Int. J. Heat Mass Transfer 55(2012) 6260–6277.
- [5] T.M. Liou, C.P. Yang, H.L. Lee, LDV measurements of spatially periodic flow over a detached solid-rib array, J. Fluid Eng. 119 (1997) 383–389.
- [6] C. Haiping, Z. Dalin, H. Taiping, Impingement heat transfer from rib roughened surface within arrays of circular jet: the effect of the relative position of the jet hole to the ribs, in: ASME Turbo Expo 1997, Orlando, FL, USA, ASME, 1997.
- [7] Y. Xing, B. Weigand, Experimental investigation of impingement heat transfer on a flat and dimpled plate with different cross flow schemes, Int. J. Heat Mass Transfer 53 (19–20) (2010) 3874–3886.

# International Journal of Innovative Research in Science, Engineering and Technology

(An ISO 3297: 2007 Certified Organization)

Website: [www.ijirset.com](http://www.ijirset.com)

Vol. 6, Issue 6, June 2017

- [8] D. Lee, Y. Chung, P. Ligrani, Jet impingement cooling of chips equipped with multiple cylindrical pedestal fins, *J. Electron. Package.* 129 (3) (2007) 221–228
- [9] N.M.R. Jeffers et al., Heat transfer from novel target surface structures to normally impinging, submerged and confined water jet, *J. Therm. Sci. Eng. Appl.* 1 (3) (2009) 031001.
- [10] L.G. Hansen, B.W. Webb, Air jet impingement heat transfer from modified surfaces, *Int. J. Heat Mass Transfer* 36 (1993) 989–997.
- [11] C. Gau, C.C. Lee, Impingement cooling flow structure and heat transfer along rib-roughened walls, *Int. J. Heat Mass Transfer* 35 (1992) 3009–3020.
- [12] C. Gau, I.C. Lee, Flow and impingement cooling heat transfer along triangular rib-roughened walls, *Int. J. Heat Mass Transfer* 43 (2000) 4405–4418.
- [13] M.E. Taslim, L. Setayeshgar, S.D. Spring, An experimental evaluation of advanced leading edge impingement cooling concepts, *J. Turbomach.* 123(2001) 147–153.
- [14] M.E. Taslim, Y. Pan, S.D. Spring, An experimental study of impingement on roughened airfoil leading-edge walls with film holes, *J. Turbo Mach.* 123 (2001) 766–773.
- [15] S.S. Hsieh, H.H. Tsai, S.C. Chan, Local heat transfer in rotating square-rib roughened and smooth channels with jet impingement, *Int. J. Heat Mass Transfer* 47 (2004) 2769–2784.
- [16] W.M. Yan, S.C. Mei, Measurement of detailed heat transfer along rib roughened surface under arrays of impinging elliptic jets, *Int. J. Heat Mass Transfer* 49 (2006) 159–170.
- [17] Y.S. Chung, D.H. Lee, J.S. Lee, Heat transfer characteristics of an axisymmetric jet impinging on the rib-roughened convex surface, *Int. J. Heat Mass Transfer* 42 (11) (1998) 2101–2110.
- [18] W.M. Yan, H.C. Liu, C.Y. Soong, W.J. Yang, Experimental study of impinging heat transfer along rib-roughened walls by using transient liquid crystal technique, *Int. J. Heat Mass Transfer* 48 (2005) 2420–2428.
- [19] H. Martin, Heat and mass transfer between impinging gas jets and solid surfaces, *Adv. Heat Transfer* 13 (1977) 1–60.
- [20] K. Jambunathan, E. Lai, M.A. Moss, B.L. Button, A review of heat transfer data for single circular jet impingement, *Int. J. Heat Fluid Flow* 13 (1992) 106–115.
- [21] R. Viskanta, Heat transfer to impinging isothermal gas and flame jets, *Exp. Therm. Fluid Sci.* 6 (1993) 111–134.
- [22] A.P. Rallabandi, D.H. Rhee, Z. Gao, J.C. Han, Heat transfer enhancement in rectangular channels with axial ribs or porous foam under through flow and impinging jet conditions, *Int. J. Heat Mass Transfer* 53 (2010) 4663–4671.
- [23] S. Ndao, H.J. Lee, Y. Peles, M.K. Jensen, Heat transfer enhancement from micro-pin fins subjected to an impinging jet, *Int. J. Heat Mass Transfer* 55 (2012) 413–421.
- [24] N.T. Obot, T.A. Trabold, Impingement heat transfer within arrays of circular jets: Part 1 – effects of minimum, intermediate, and complete cross flow for small and large spacing, *Trans. ASME – J. Heat Transfer* 109 (1987) 872–879.
- [25] G.E. Andrews, C.I. Hussain, Impingement cooling of gas turbine component. *Proceeding of Tokyo International Gas Turbine Congress and Exhibition* 1983.
- [26] A.M. Huber, R. Viskanta, Effect of jet–jet spacing on convective heat transfer to confined impinging arrays of axisymmetric air jets, *Int. J. Heat Mass Transfer* 37 (18) (1994) 2859–2869.
- [27] S. Caliskan, S. Baskaya, Experimental investigation of impinging jet array heat transfer from a surface with V-shaped and convergent-divergent ribs, *Int. J. Therm. Sci.* 59 (2012) 234–246.