

# International Journal of Innovative Research in Science, Engineering and Technology

(An ISO 3297: 2007 Certified Organization)

Website: [www.ijirset.com](http://www.ijirset.com)

Vol. 6, Issue 6, June 2017

## Implementation of AMMSG: AUTOMOBILE SAFETY GEAR

Miloni Ganatra<sup>1</sup>, Ashwin Patani<sup>2</sup>

Assistant Professor, Department of Electrical & Electronics Engineering Engineering, INDUS University, Ahmedabad  
Gujarat, India<sup>1</sup>

Assistant Professor, Department of Electrical & Electronics Engineering Engineering, INDUS University, Ahmedabad  
Gujarat, India<sup>2</sup>

**ABSTRACT:** In today's world more and more people are opting for automobiles too make their life easier and with this there is also a tremendous increase in the amount of road accidents and vehicle thefts that takes place on a regular basis. So the need of the hour is to reduce the no of accidents and automobile thefts. So in order to reduce the casualties due to the above two reasons we have developed a simple cost effective system which uses simple methods to ensure the safety of both the passenger as well as their vehicle. Facts have it that most of the accidents are caused due to the alcohol consumption of the driver and in majority of the cases the casualties of the life can be reduced if the passengers would have worn their seat belt .here ASG (Automobile safety gear ) is mainly divided into three parts where in the first phase the alcohol , gas and temperature levels are checked and if all the parameters are in control and the seat belt is also worn ,then the automobile will get started...otherwise the buzzer and LCD are used to indicate the alert. In the second phase after the vehicle gets started again all these parameters are continuously checked and in case of failure of any parameter .the vehicle would stop with the buzzer turning on and a message alert would also be sent to a mobile no. And after once the vehicle is stopped then antitheft button is pressed so that the current location of the vehicle gets locked and in case of any change in the location beyond a limit then the system would continuously send alert messages with the current position of the vehicle in it to a concerned mobile number thus helping to track the vehicle in case of theft. Thus with our project we are expecting to make driving safe and reduce the no of thefts. The best part of the system is the cost effectiveness and the sophisticated instruments used in this project which can ensure safety and can be used by all the automobiles irrespective of their segment.

**KEYWORDS:** SMD: Surface Mounted Device, AMMSG: Automobile safety gear

### I. INTRODUCTION

#### 1. Motivation:

The automobile industry has developed significantly in the recent years with the progress of technology. In recent years it has come up with many technologies to meet the safety and convenience of its consumer's .But most of the safety devices comes in high end cars which the middle class won't be able to afford. So our main motto behind the project was to create a cost efficient accident prevention kit...where we reduce the possibility of the occurrence of the accident.

#### 2. Aim & Objectives:

**Aim:** To reduce the no of road accidents and automobile thefts by giving the automobile owners a cost effective system which can be used in all kinds of automobiles irrespective of its budget or segment alike.

**Objectives:** To reduce the no of road accidents

- To reduce the no of automobile thefts

# International Journal of Innovative Research in Science, Engineering and Technology

(An ISO 3297: 2007 Certified Organization)

Website: [www.ijirset.com](http://www.ijirset.com)

Vol. 6, Issue 6, June 2017

- To help government make citizens obey the traffic rules
  - To reduce the casualties of life and wealth
  - To give stress free roads to the citizens

## II. BASIC PRINCIPLE

The basic principle here is to prevent an accident before it occurs. It is observed that in many of the cases the accident occurs because of the carelessness of man while driving like the cases of drunk & drive and it is observed that most of the people especially teenagers drive without wearing a seatbelt which increases the possibility of death in case of an accident . It is also observed that the no of vehicle thefts in INDIA as well as the whole world is increasing at a tremendous rate. The project described in this paper discusses about how to create a cost and service efficient system using components like ATMEGA 32 microcontroller, MQ3 sensor, MQ7 sensor and GPS-GSM modules. Thus our main principle here to check all these parameters before the starting and during driving and alert the people concerned before any kind of disaster occurs. Here the vehicle would not start unless all the safety measures are checked thoroughly and after once the vehicle gets started after checking all the parameters then also the checking cycle goes on and in case of any parameter changes beyond limit the system would stop the vehicle and would send a text message using GSM system. In case of theft the system would send the exact location of the vehicle using GPS GSM modules. Thus in case both the safety of the passengers as well as the automobile can be ensured using this device.

## III. BLOCK DIAGRAM

The above diagram describes the block diagram of ASG (Automobile Safety Gear) where the components like motor, driving IC, Alcohol sensor, LPG sensor, Temp sensor, LEDs, LCD & GSM are connected and interfaced to the microcontroller i.e. ATMEGA 32 the heart of this project is the microcontroller which consist of 32 i/o pins. The project is basically powered by 12V DC supply. The project consist mainly of GPS-GSM module which acts as input devices whereas the components like LEDs,LCD and buzzer acts as output devices, Here in this project the motor is driven with the help of driver IC and 12V relay. Here the TX of the GPS module is connected to the Rx of the microcontroller and the RX of the GSM is connected to the TX of the microcontroller. And in case of any alert the message is sent to a phone no. with the help of the GSM module. The LCD here is used to display the current status and the working of the whole system. Here in the above diagram the indicators consist of 3 LEDs out of which 2 are red and 1 is green. The red ones are used to display the power supply and the green one is used to display the running of the motor. Here the motor used in the project are of 100 rpm and operates on 12 V which is used to move the automobile in case if all the pre requisite conditions are satisfied.

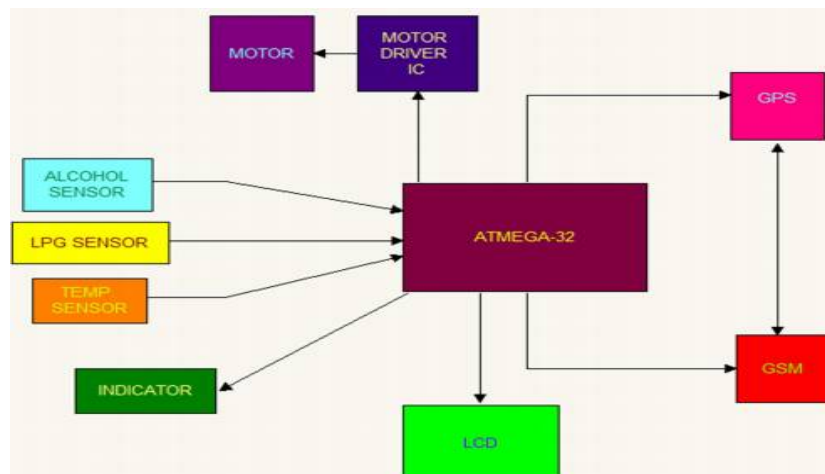

Fig. 1: Block Diagram of Automobile Safety Gear)

# International Journal of Innovative Research in Science, Engineering and Technology

(An ISO 3297: 2007 Certified Organization)

Website: [www.ijirset.com](http://www.ijirset.com)

Vol. 6, Issue 6, June 2017

## IV. SURVEY

### 1. Survey on Vehicle Tracking System

A design to tracking a unit that uses the global positioning system to determine the precise location of a object, person or other asset to which it is attached and using GSM modem this information can be transmit to remote user. It can provide telemonitoring system for inter-cities transportation vehicles such as taxis and buses. This system contains single-board embedded system that is equipped with GPS and GSM modems along with ARM processor that is installed in the vehicle. During object motion, its location can be reported by SMS message. A software package is developed to read, process, analyze and store the incoming SMS messages. The use of GSM and GPS technologies allows the system to track object and provides the most up-to-date information about ongoing trips. If a password like SMS is sent by the owner, it automatically stops the vehicle or we can use it for different other work, it can provide real time control. . This system finds its application in real time traffic surveillance. It could be used as a valuable tool for real time traveler. The current system can be able to provide monitoring process from anywhere. The purpose of this system is to design and integrate a new system which is integrated with GPS- GSM to provide following feature: a) Location information, b) Real time tracking using SMS, c) track bus driver activity d) Communication is instantaneous therefore we can receive running report quickly. It is completely integrated so that once it is implemented in all vehicles, then it is easy to track vehicles any time.

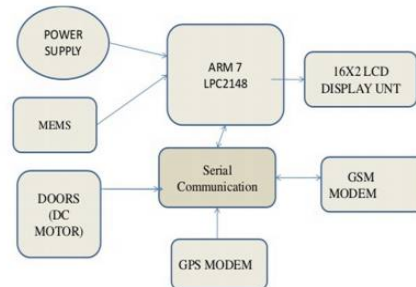

Fig 2. Vehicle Tracking using ARM

### 2. Survey on Alcohol Detection System

The purpose of this project is to develop vehicle accident prevention by method of alcohol detector in an effort to reduce traffic accident cases based on driving under the influence alcohol. This project is developed by integrating the alcohol sensor with the microcontroller 16F877A. The alcohol sensor used in this project is MQ-2 which to detect the alcohol content in human breath. An ignition system which will produce spark plugs is build up as a prototype to act like the ignition starter over the vehicle's engine. The ignition system will store the incoming SMS messages. The use of GSM and GPS technologies allows the system to track object and provides the most up-to-date information about ongoing trips.

# International Journal of Innovative Research in Science, Engineering and Technology

(An ISO 3297: 2007 Certified Organization)

Website: [www.ijirset.com](http://www.ijirset.com)

Vol. 6, Issue 6, June 2017

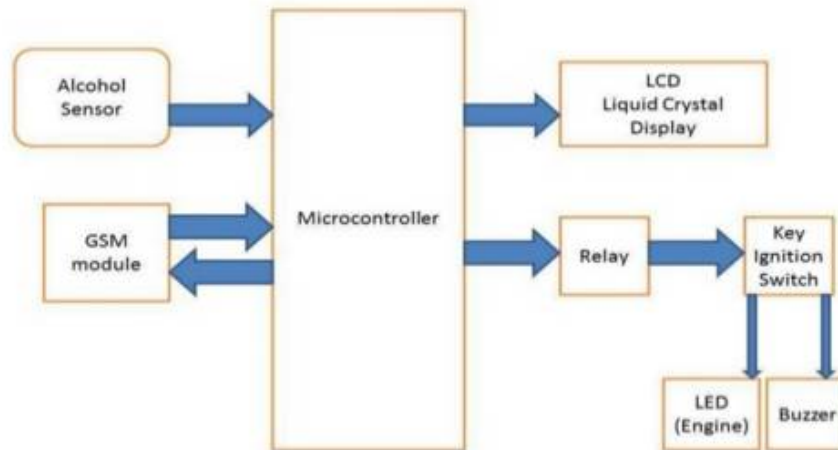

Fig. 3 Alcohol detection system

If a password like SMS is sent by the owner, it automatically stops the vehicle or we can use it for different other work, it can provide real time control. . This system finds its application in real time traffic surveillance. It could be used as a valuable tool for real time traveler. The current system can be able to provide monitoring process from anywhere. The purpose of this system is to design and integrate a new system which is integrated with GPS- GSM to provide following feature: a) Location information, b) Real time tracking using SMS, c) track bus driver activity d) Communication is instantaneous therefore we can receive running report quickly. It is completely integrated so that once it is implemented in all vehicles, then it is easy to track vehicles any time.

### 3. Survey on Smoke Detection System

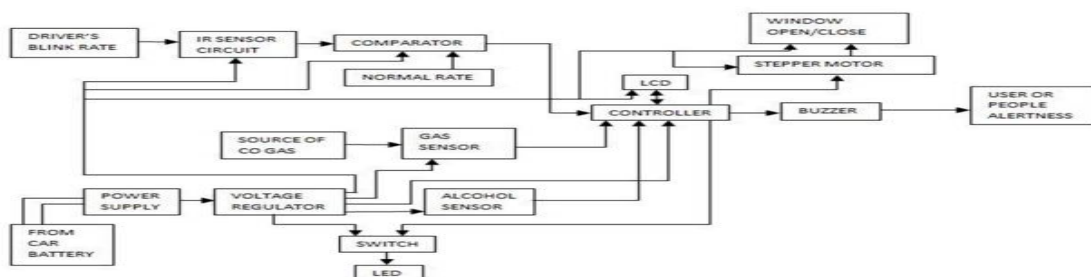

Fig 4 Block diagram of smoke detection system

Fuzzy logic to make a one gazette which controls the emission of toxic gases, smoke inside the vehicle and avoid drunken drive. Sometimes during the long drive or whole night driving driver may feel sleepy which is also dangerous for passengers, through the blinker system and eye lid blinking if the count is less, then auto alarm which may indicate the toxic gas, smoke level through alarm sound must be made alert for drivers and passengers. And if the driver is drinking then through the control unit the vehicle door is not opening and if door is not locked then engine is not ignited. If the toxic gas level is increasing then through auto control system the window will open while the level is decrease then it may be closed.

# International Journal of Innovative Research in Science, Engineering and Technology

(An ISO 3297: 2007 Certified Organization)

Website: [www.ijirset.com](http://www.ijirset.com)

Vol. 6, Issue 6, June 2017

## 2. Survey on Seat Belt and Engine Lock System

This paper was aim to development of smart helmet detection system and seat belt detection system for dune buggy to avoid or reduce the accident fatigue on drivers during accident. Driver will be unable to start vehicle without wearing seat belt and helmet. An ultrasonic sensor HC/SR04 was used for detecting the driver helmet, ATmega328 microcontroller to control the entire safety system. The technology connects the drivers and the co passenger seat belts with the Ignition system such that without fastening the seat belts, the dune buggy will not start. If the driver unfastens their seat belt or helmet is removed after starting off vehicle, the control unit will disengage the power input to the ignition switch after 30 seconds resulting in halt position.

## 3. Survey on Temperature Sensing

This wasAim to measurement the temperature around an automotive engine and it is one of the contributing character in improving an automotive engine's performance and life time. The method of measuring the temperature is a tricky aspect which has to be done in a suitable else the measurement method may give inappropriate understanding about the temperature around the engine. [9] Measuring the characteristics of temperature is an important technologic process to improve the quality of automobile products and work efficiency. An embedded temperature characteristics measurement system for automotive temperature sensing is designed employing AT89C55 as kernel and pre-emptive real time embedded operating system  $\mu$ C/OS-software platform which gives the system the capability of multitasking in real time and meets the needs of the prototyping.

### Critical Analysis and Integrating:

Existing System/Survey On:	Platform/Technology	All safety concern check
Vehicle Tracking	ARM7,GSM,GPS	NO
Alcohol	8051	NO
Smoke	ATMEGA8	NO
Seat belt	Arduino	NO
Temperature	Atmega89C55	NO

Table 1: Critical Analysis & Integrating

# International Journal of Innovative Research in Science, Engineering and Technology

(An ISO 3297: 2007 Certified Organization)

Website: [www.ijirset.com](http://www.ijirset.com)

Vol. 6, Issue 6, June 2017

## V. FLOW DIAGRAM

As we can see in the fig, when the user starts the engine, it checks four stage condition process in which Alcohol detection, Smoke detection, Over Temperature detection and Seatbelt detection takes place. If any one of them is not satisfied then the engine will not start and the user won't be able to take control of the car. Suppose if anyone condition is not satisfied then we have interface GSM system which will send the message to the user/police/relative as it is programmed. Now if the user has parked the car and went away by turning the engine off, then if a burglar tries to get away with the car then its location will be send to user's mobile continuously after a particular time interval as programmed.

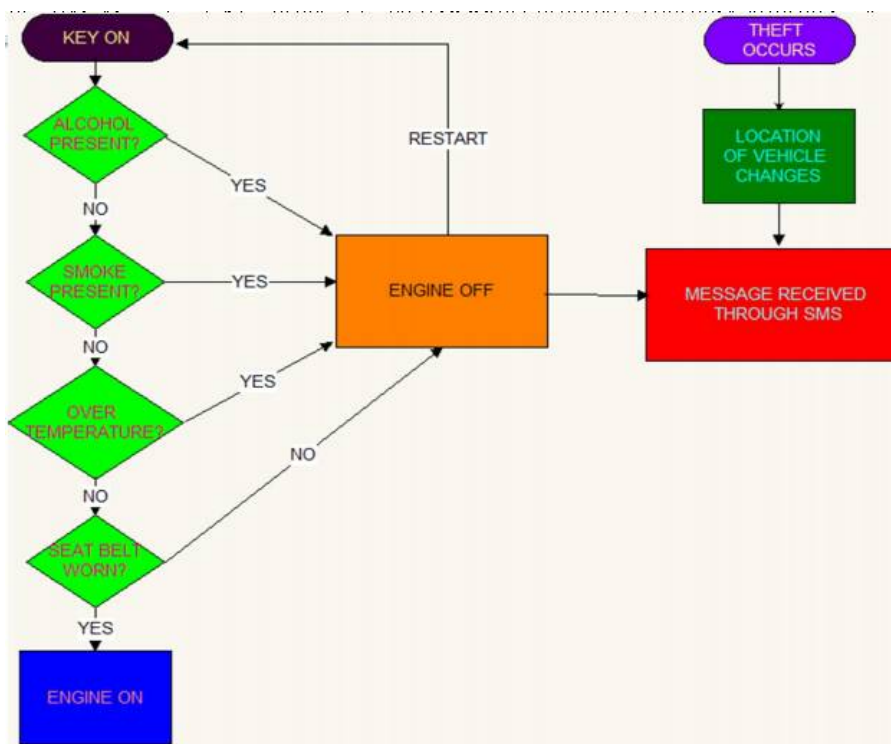

Fig 5: Flow Diagram of Automobile Safety Gear

## VI. METHODOLOGY

**Step 1: Power Supply Unit:** The power supply unit uses a voltage regulator to obtain 5V from 12V Supply. Two electrolytic capacitors of 1000uF are connected in parallel with pin 1 and pin 2 of voltage regulator, and one electrolytic capacitor of 470uF and one ceramic capacitor are connected in parallel across pin 3 and pin 2 of voltage regulator. Pin 2 on voltage regulator is grounded. Pin 3 of voltage regulator gives required +5V and is connected to burg strip to obtain Common VCC and Pin 2 is connected to burg strip to obtain Common Ground. A resistor of 1K and an indicating Led is connected between common VCC and Common GND burg Strip.

**Step 2: LCD Interfacing with Microcontroller:** LCD used in the circuit is 16x2 LCD display. The LCD consists of 16 pins and these pins re connected to PORT C of microcontroller. Pin 1 and 2 are VDD and VSS pins respectively with are connected to Common GND and Common VCC strip. Pin 4, 5 and 6 of LCD are RS, RW and EN pins respectively which are connected to PC0, PC1 and PC2 pin i.e. pin 12V supply Voltage Regulator +5V GND Indicator LED PIN 1 AUTOMOBILE SAFETY GEAR INDUS UNIVERSITY 34 no. 22, 23 and 24 of microcontroller. Pin 7-14 of LCD are data line pins from these pins pin no 11,12,13 and 14 i.e. D4,D5,D6 and D7 are connected to PC4,PC5,PC6 and PC7

## International Journal of Innovative Research in Science, Engineering and Technology

(An ISO 3297: 2007 Certified Organization)

Website: [www.ijirset.com](http://www.ijirset.com)

Vol. 6, Issue 6, June 2017

pin i.e. 26,26,28 and 29 pin no of microcontroller. A pre-set is connected to Pin 3 of LCD to adjust contrast of LCD display.

Step 3: **Temperature Sensor:** the temperature sensor LM35 in the circuit above. The output and the ground is connected to a ceramic capacitor. The output pin of the LM35 is connected to the ADC pin i.e. PA0 pin no. 40 of the microcontroller.

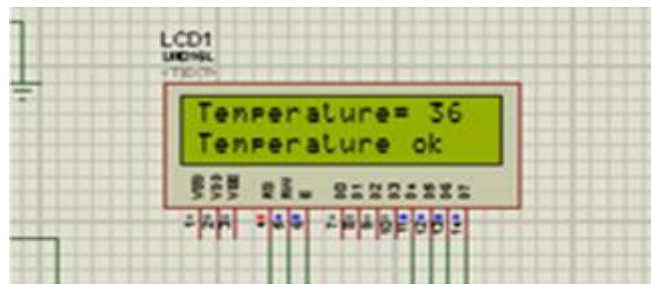

Fig 6: Temperature Test

Step 4: **Alcohol Sensor:** the circuit of alcohol sensor (MQ7) in the circuit. Here we have used an already mounted MQ7 module which consists of only three pins. They are VCC, GND and output of the alcohol sensor. Here the output of the sensor is connected to the AD6 pin which is the PA6 pin i.e. Pin no 34 of the microcontroller. Here the pins are connected to the ground after passing through 10k resistors.



Fig.7 : Alcohol Test

Step 5: **Gas Sensor:** the arrangement of the sensor is same as that of the alcohol sensor where three pins are connected to the VCC and out of the rest, one is connected to the ground after passing through 10k resistor and ceramic capacitor whereas the other is connected to the ground after passing through the 10k resistor. Here the output of the sensor is connected to the PA4 pin i.e. pin no.36 of the microcontroller.



Fig 8 : Smoke Test

## International Journal of Innovative Research in Science, Engineering and Technology

(An ISO 3297: 2007 Certified Organization)

Website: [www.ijirset.com](http://www.ijirset.com)

Vol. 6, Issue 6, June 2017

Step 6: **Motor Drive:** the relay circuit and the motor driving IC circuit required for driving the IC. Here the 3, 6, 14 and 11 pin of the L293d are connected to the motor and the 1 and the 9 pin are connected to the relay. Here a capacitor of 2200 micro faraday is connected to the relay to give the necessary starting torque required to start the motor.

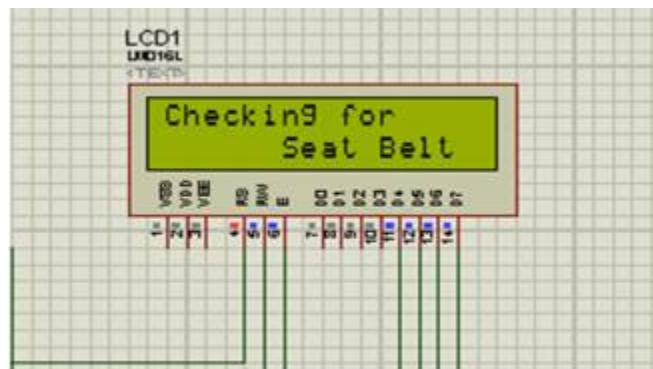

Fig 9 : Checking for Seat Belt

Step 7: **GSM and GPS Interfacing:** RX and TX pin of microcontroller i.e. pin no ... and ... respectively are brought out by connecting them to burg strip. The first terminal of both the burg strips is grounded while the second terminal is RX and TX pin of controller. The RX pin of controller is connected with TX pin of GPS while the TX pin of controller is connected to RX pin of GSM. The ground pin of burg strip is connected to GND of GSM and GPS module.

Step 8: **Switching Unit:** first push button is for resetting the whole system and is connected to the reset pin of the microcontroller. The second button in the above pic is used for starting of the system and is connected to the first pin of the microcontroller. The third button on the other PCB is used as an antitheft button which is connected to the PB1 pin of the microcontroller and the other switch is for seatbelt.



Fig 10 : Parameters Checked



# International Journal of Innovative Research in Science, Engineering and Technology

(An ISO 3297: 2007 Certified Organization)

Website: [www.ijirset.com](http://www.ijirset.com)

Vol. 6, Issue 6, June 2017

## Step 9: Full Implemented Hardware

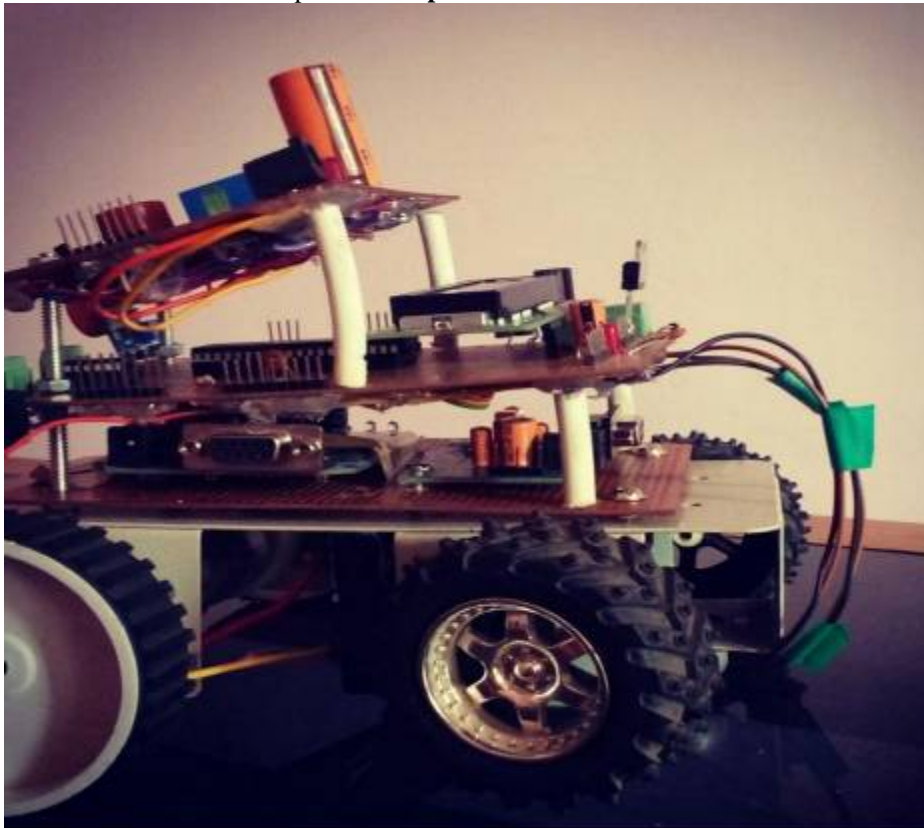

Fig. 11: Implemented Hardware

## VII. RESULT ANALYSIS

1. Connect the power supply to the GPS-GSM, LCD, sensors and the other components of the circuit and then turn on the circuit.
2. When we switch on the circuit by pushing the start button the process of checking of alcohol temp, seatbelt & gas starts
3. If all the 4 parameters are satisfied then we are all set to start the vehicle in the above process and the vehicle starts. The starting of the vehicle is indicated by the green LED and the LCD will display a message.
4. In the above case if any of the parameters are above their pre-set value then the buzzer turns on and the green LED turns off the below figure shows the image of the circuit when the alcohol limit exceeds its normal value that is 450. The above same case also applies when gas, seatbelt or temperature exceeds.
5. The first 4 messages describe the position of the vehicle when the theft occurs. The fifth message in the line describes about the over gas. The sixth message comes to the mobile when temperature crosses the normal value.

# International Journal of Innovative Research in Science, Engineering and Technology

(An ISO 3297: 2007 Certified Organization)

Website: [www.ijirset.com](http://www.ijirset.com)

Vol. 6, Issue 6, June 2017

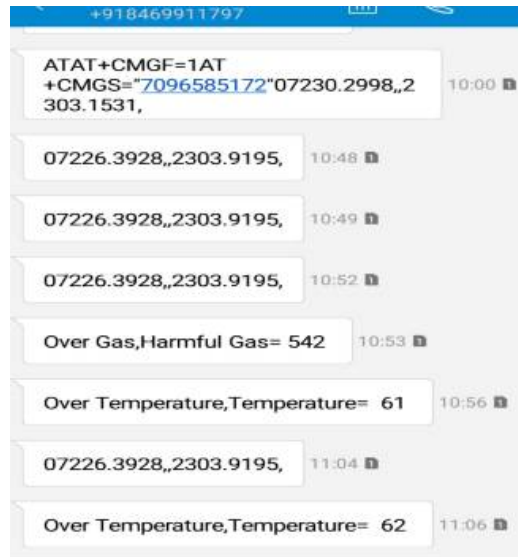

Fig. 12: Messages sent to the registered mobile

The above picture shows the image of the message that is received when the alcohol crosses the normal value and the motor is stopped while driving. The second image describes the message that is received when the driver is yet to wear the seatbelt or has removed the seatbelt when the motor is on

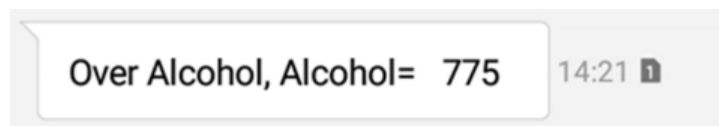

Fig. 13: Over alcohol message

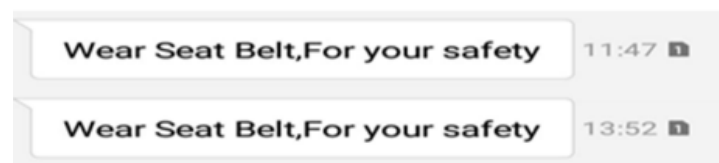

Fig.14 : Seat Belt message

## VIII. CONCLUSION

We have tried to reduce the no of accidents by preventing the causes that lead to such accidents. As this project is cost effective it can be applied to all the segments of cars alike. If we can successfully implement such type of designs and its advanced versions on a larger scale then it is sure to produce some positive results. The main motive behind this project was to integrate the safety components of all the need and to protect public spending on the material worthwhile by stopping the theft. With much technological advancement we sincerely hope that this circuit work can be implementing at Nano or below that level to the existing car electronics circuit

## IX. FUTURE WORK

With day by day new start-ups coming up, this technology can be used to license to the car manufacturers and make it compulsory to implement the technology for people's safety. There may be a chance that government will pass an

# International Journal of Innovative Research in Science, Engineering and Technology

(An ISO 3297: 2007 Certified Organization)

Website: [www.ijirset.com](http://www.ijirset.com)

Vol. 6, Issue 6, June 2017

amendment in the future for making the vehicles more reliable and safer for people to travel as medium. The theft cases can be reduced to a great extent. Already many manufacturers are trying to implement but due to some complexity they are not able to implement it but in the near future there is a great chance that we all sit in car that it self-decide whether the driver is compatible to drive or not. With Google inventing the driver less car there may be chance that car will drive own its own if the driver is not fit to drive. We can imagine only how the future will be, it is our hope that it goes beyond our expectations and we see a thriving 21st Century.

## REFERENCES

- [1] Abed khan M.E.(Student), Ravi Mishra, "GPS – GSM Based Tracking System" SSCET, CSVTU, Bhilai, India International Journal of Engineering Trends and Technology- vol.3,no..pp,161-164, 2012.
- [2]Elia Nadira Sabudin, Siti Zarina Mohd Muji, Mohd. Helmy Abd Wahab, Ayob Johari, Norazman Bin Ghani, "GSM-based Notification Speed Detection for Monitoring Purposes", IEEE, Department of Computer Engineering, University Tun Hussein Onn Malaysia in 2008.
- [3] Vaishnavi.M , Umadevi.V , Vinothini.M , Bhaskar Rao .Y , Pavithra.S INTELLIGENT ALCOHOL DETECTION SYSTEM FOR CAR International Journal of Scientific & Engineering Research, Volume 5, Issue 11, November-2014 598 ISSN 2229-5518 IJSER © 2014.
- [4] Chou, S.P., Grant, B.F., Dawson, D.A., Stinson, F.S., Saha, T., Pickering, R.P. 2006. "Twelve month prevalence and changes in driving after drinking." United States, 1991-1992 and 2001-2002. Alcohol Research and Health, 29, 143-151.
- [5] M.K.MISHRA, S.Mohanraj, T.Yazhini, K.Vijayasri, R.Gomathi "Fuzzy Based Model for Accident Prevent System"International Journal of Scientific and Research Publications, Volume 3, Issue 3, March 2013 1 ISSN 2250-3153.
- [6] Win, D. T. 2006. Breath Alcohol Testers. Prevent Road Accidents. Faculty of Science and Technology, Assumption University Bangkok, Thailand.
- [7] S. Anil Babu, Sumathi Ayyalusamy, Rejin Ranjit Singh, Sreejin Dharmarajan, Jason James, Mohamed Anas Assistant Professor, School of Engineering & IT, Manipal University Dubai campus, International Academic City, Dubai, UAE. Undergraduate Student, School of Engineering & IT, Manipal University Dubai campus, International Academic City, Dubai, UAE "Development of Helmet Detection System & Smart Seat Belt"IOSR Journal of Electronics and Communication Engineering (IOSR-JECE) e-ISSN: 2278-2834,p- ISSN: 2278-8735.Volume 10, Issue 4, Ver. II (Jul - Aug .2015), PP 55- 59 [www.iosrjournals.org](http://www.iosrjournals.org) DOI: 10.9790/2834-10425559.
- [8] Mr. G.V.Bharadwaja Sarma, Mr. Ch.Nagaraju. G.V.BHARADWAJA SARMA [1] . Mr. CH.NAGARAJU [2] M.Tech, Embedded systems, AITS, Department of ECE, Associate Professor Rajampet, Kadapa (Dist.) AITS, Rajampet, Kadapa (Dist.) International Journal of Engineering Research and Applications (IJERA) ISSN: 2248-9622 [www.ijera.com](http://www.ijera.com) Vol. 2, Issue4, July-august 2012, pp.1425-1429 1425. Automotive Engine Temperature Control Employing Apt Temperature Measurement And Control Measures.
- [9] Resistance-temperature Characteristic Measurement System for Automotive Temperature Sensor Based on  $\mu$ C/OS- II , Hui Chen IEEE 2011.