

International Journal of Innovative Research in Science, Engineering and Technology

(An ISO 3297: 2007 Certified Organization)

Website: www.ijirset.com

Vol. 6, Issue 3, March 2017

Real Time Automated Office Security System

S.Anjana Devi¹, T.Chiranjeevi², S.S.N.Haneesh³, Yoga Sai Kiran Vaddi⁴, M.Maha Lakshmi⁵, P.Naga Teja⁶

Students, Department of Electronics and Communication Engineering, DMS SVH College of Engineering,

Andhra Pradesh, India. ^{1,3,4,5,6}

Assistant Professor, Department of Electronics and Communication Engineering, DMS SVH College of Engineering,

Andhra Pradesh, India²

ABSTRACT: Now-a-days, robbery is the major issue in the world. This may be about property or information. To avoid this complication security cameras are being used everywhere. Although this hadn't vanished the problem totally. To get rid of this, this project provides automation which plays a very important role in today's world. In this automated mode the system controls the applications itself depending on some sensor reading. The system in this project is spatially distributed sensors in an autonomous manner to monitor and protect the particular selected area using closed circuit camera. For every unauthorized gesture at an unauthorized hour the administrator gets intimated. To design this system, we are using Raspberry pi board with help of PIR sensor to detect the motion of the human, smoke sensor to detect the fire or smoke and GSM module to intimate administrator.

KEYWORDS: automation, security, cc camera, administrator, Raspberry Pi, PIR sensor, Smoke sensor, GSM module.

I. INTRODUCTION

In recent years, owing to growing problems affecting private security, security related research effects have gained increasing attention and many simple and small security systems are starting to be developed. At present commonly adopted security measure include the use of close circuit camera systems, security guards, infrared sensors, others. For this study, we developed a high sensitivity system which instead depending on a living being, it depends on electronic sensors and also some motors and modules which helps for the automation of the entire system.

II. RELATED WORK

The idea of this project is the brand new one. The time, at which we are trying to start a project, the bank robberies were seen more. At that time a robbery of 12kg of gold was happened in muthoot finance gold financing company at one of the Hyderabad branch. Along with the gold, the robbers have also snatched the hard disk of cc camera so that they cannot be arrested by police as there will be no proofs. To avoid such limitations, we have come with the idea of locking the thief and intimating to administrator as well as police when the tries for a robbery. And furthermore we have added the applications like fire detection and battery backup and wiper. To complete this project, we have referred several papers that are mentioned in references.

III. APPLICATIONS

A. FAULT TECHNOLOGY

A fault is defined as an abnormal condition or defect at the component, equipment or subsystem level which may lead to a failure[1]. This system is designed with fault technology to overcome power failures whenever a thief disables the power supply to the camera.

International Journal of Innovative Research in Science, Engineering and Technology

(An ISO 3297: 2007 Certified Organization)

Website: www.ijirset.com

Vol. 6, Issue 3, March 2017

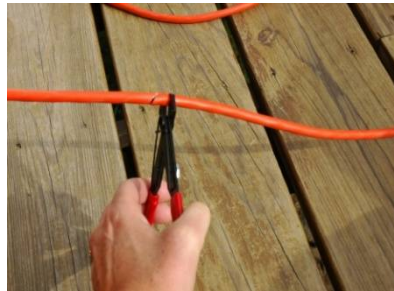

Fig.1: Unauthorised person cutting the power cable of camera

B. OBJECT DETECTION

If any unauthorised person enters into the private room, the infrared radiation coming from his body is being detected by using passive infrared sensor and instantly the unauthorised person gets locked in the room and at the same time the system makes a call to the administrator as well as police station informing about the uncertain action and also a buzzer is given to alert the security guards.

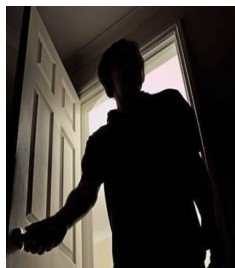

Fig.2: unauthorised person entering Into a private room

C. INFORMATION SECURITY

In extension to the above application, this application was designed. The unauthorised person who was locked in the room has a possibility to theft the information in the systems or files and he can also transfer the information through social networks. To prevent these situations whenever the passive infrared sensor discerns the motion of human, it spreads chloroform over the room. This can provide security to the capital information which is present in the electronic gadgets or files in that particular room.



Fig.3: Unauthorised person thefting Confidential information

International Journal of Innovative Research in Science, Engineering and Technology

(An ISO 3297: 2007 Certified Organization)

Website: www.ijirset.com

Vol. 6, Issue 3, March 2017

D. SMOKE DETECTION

If any fire accidents arise due to any short circuits in the room, instantly the water sprinklers which have been arranged prior sprinkles the water over the room so that the damage will be less and at the same time the system calls the administrator as well as fire station informing about the uncertain action and also a buzzer is given to alert the security guards.



Fig.4: Fire accident in a closed area

E. WIPER

Sometimes the camera screen may have dust as it is consistently at one place. Then the captured video will not be clear. To get rid of this, a wiper was arranged on the lens of the camera so that the dust will be cleaned once in a while.



Fig.5: Wiper wipes the dust on camera

IV. BLOCK DIAGRAM

Fig.6 clearly explains the whole proposed system. The main component is the RASPBERRY PI 3B with Broadcom BCM 2837 system which includes a 1.2 GHz Quad core ARM cortex A53 processor. Sensors, circuit break and power fail are given as the inputs to the processor. The captured audio and video signals are displayed on the monitor and mobile. Therefore the administrator can track the exact situation in his private room.

International Journal of Innovative Research in Science, Engineering and Technology

(An ISO 3297: 2007 Certified Organization)

Website: www.ijirset.com

Vol. 6, Issue 3, March 2017

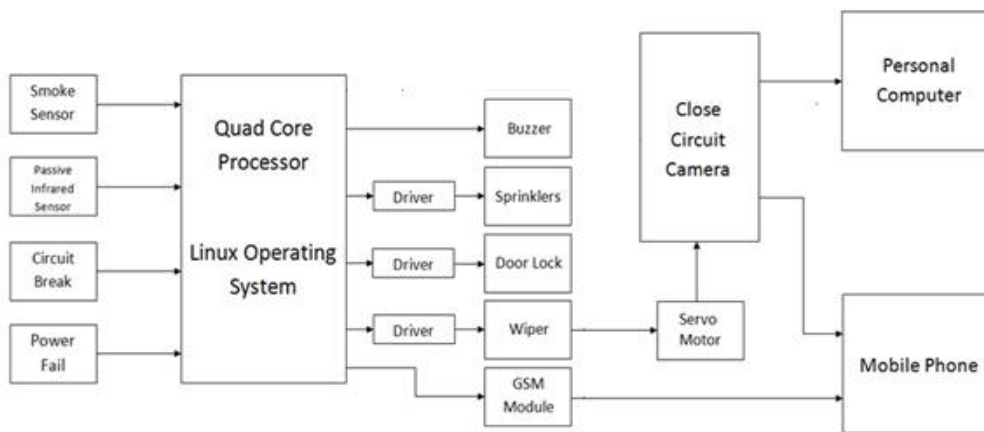

Fig.6: System Overview

If any misleading activities arise in room then this system can take the necessary action like locking the thief and intimating the administrator.



Fig.7: RASPBERRY PI Board

A. **RASPBERRY PI :**

The RASPBERRY PI 3 B with Broadcom BCM 2837 system which includes a 1.2 GHz Quad core ARM cortex A53 processor. The processor has 40 pins. Among these pins 24 are General Purpose Input /Output pins, 8 are Ground pins, 4 are VCC pins and 2 pins are reserved for future use. It consists 1 GB of RAM [4]. It doesn't have a built-in hard disk but uses an SD card for booting. It consists of various hardware components such as Ethernet socket, HDMI socket, USB 2.0 socket, SD card socket, Powered for micro USB socket, General Purpose Input Output pins, Video and Audio jack, Camera Port.

International Journal of Innovative Research in Science, Engineering and Technology

(An ISO 3297: 2007 Certified Organization)

Website: www.ijirset.com

Vol. 6, Issue 3, March 2017

B. PASSIVE INFRARED SENSOR :

The Passive Infrared Sensor is a electronic sensor which discerns the infrared radiation emitting from the objects and it is based on infrared technology [2]. The voltage range is DC 4.5V to 20V. The sensitivity and the holding time can be adjusted. The features of this sensor are automatic induction, photosensitive control, unrepeatable trigger and repeatable trigger.



Fig.8: Passive Infrared Sensor

C. SMOKE SENSOR :

The smoke sensor detects the concentrations of combustibile gas in the air and the outputs its reading as an analog voltage[3].The sensor can measure concentrations of flammable gas from 300 to 10,000 ppm and operates at temperatures between -20 C to 50 C. Sensitivity can be adjusted by the potentiometer. It detects gases like H₂, LPG, CH₄, CO, Alcohol, Smoke, Propane and other flammable gases.



Fig.9: Smoke Sensor

D. GSM MODULE :

The GSM 800A uses dual band 1800/1900 MHz frequencies. The frequency bands can be set by AT commands. The baud rate is configurable from 1200 to 115200 through AT commands. GSM modem is having TCP/IP stack to enable you to connect with internet via GPRS [5]. This is an ultra compact and reliable wireless module. This is a complete GSM module in a SMT type and designed with a very powerful single chip processor integrating ARM926EJ-S core. The modem consists of power regulation, external antenna, SIM holder and other external components assembled to it. It can accept commands from microcontroller UART.



Fig.10: GSM Module

International Journal of Innovative Research in Science, Engineering and Technology

(An ISO 3297: 2007 Certified Organization)

Website: www.ijirset.com

Vol. 6, Issue 3, March 2017

E. SERVO MOTOR :

A Servo Motor is a rotator actuator or linear actuator that allows for precise control of angular or linear position, velocity and acceleration. It consists of a suitable motor coupled to a sensor for position feedback. It operates on a voltage of 4.8V. The rotational range of the servo motor is 180 degree.



Fig.11: Servo Motor

F. SPRINKLERS :

The entire systems of pipes and sprinklers intended for fire suppression within buildings. The sprinklers are used to sprinkle the water whenever a smoke sensor detects the smoke inside a closed area. Therefore the fire can be controlled and the damage will be very less.



Fig.12: sprinkler

G. WIPER :

The wipers are the blades that clean the lens of the camera so that the captured video will be clear. Generally the cc cameras are placed at the corners of the room, so that the cc camera lens will be covered with dust. To overcome this problem a wiper is placed to clean the lens of the cc camera.



Fig.13: cc camera with wiper

V. HARDWARE IMPLEMENTATION

The Raspberry Pi board consists of 24 GPIO (General Purpose Input Output) pins. PIR sensor has 3 pins which are power, ground and signal pin. This sensor is interfaced with raspberry pi board by using jumpers, a python coding is used internally to detect the infrared rays emitting from the body. When the infrared rays of the body are detected immediately the thief gets locked in the room and a call and SMS are sent to administrator as well as police station and also a buzzer is given to alert the security. In extension to this application, the thief in the room gets fainted by spreading the chloroform over the room. Similarly smoke sensor also has 3 pins power, ground and signal pin and it is

International Journal of Innovative Research in Science, Engineering and Technology

(An ISO 3297: 2007 Certified Organization)

Website: www.ijirset.com

Vol. 6, Issue 3, March 2017

interfaced with raspberry pi using jumper, and a python code is run to detect smoke. And when the smoke is detected instantly water is sprinkled through sprinklers and also a call and SMS are sent to administrator as well as fire station. A buzzer is given to alert the security.

Whenever the power to the camera is disabled immediately a message is sent to the administrator and a power backup is provided to the camera. If the camera screen is covered with dust then the wiper is set to clean the camera screen for every 24 hours.

VI. RESULT

- A. Whenever the Passive Infrared Sensor detects the infrared rays from the object then the GSM module immediately calls and sends a message to the administrator as well as police. . If a call is sent to the administrator he can alert at the night time when he was sleeping.

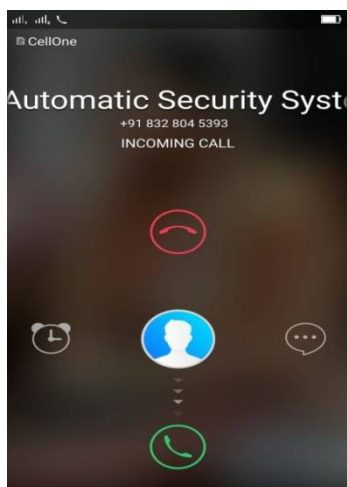

Fig.14: call from the security system

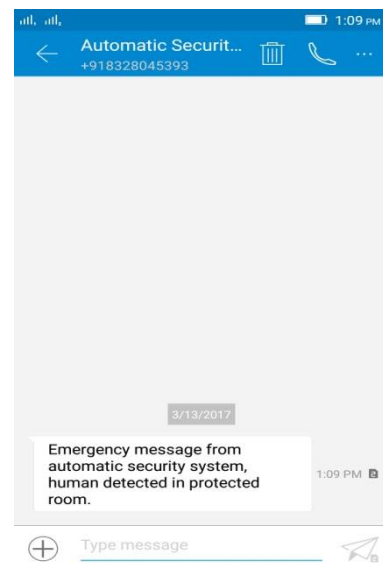

Fig.15: SMS from the security system intimating that a person entered the room.

- B. Whenever the smoke sensor detects the smoke then the GSM module immediately calls and sends a message to the administrator as well as fire station. If a call is sent to the administrator he can alert at the night time when he was sleeping.

International Journal of Innovative Research in Science, Engineering and Technology

(An ISO 3297: 2007 Certified Organization)

Website: www.ijirset.com

Vol. 6, Issue 3, March 2017

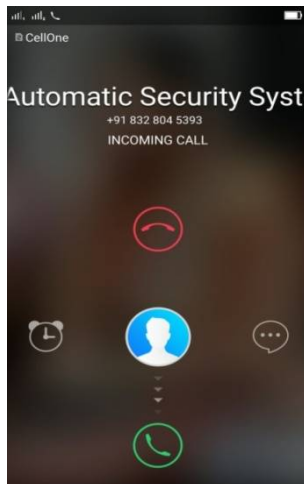

Fig.16: call from the security system

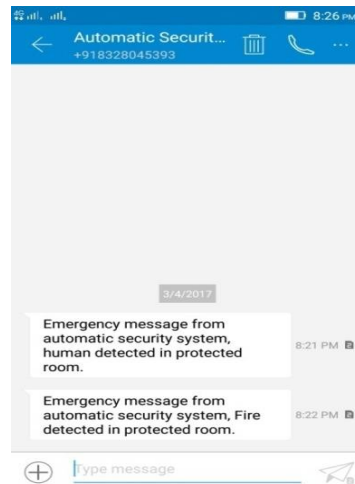

Fig.17: SMS from security system intimating that fire is detected

We haven't included the SMS that will be sent to police and fire station. That SMS also contains the location which was set prior.

VII. CONCLUSION

We have designed an automatic alerting security system till now and the further work is going on. Our system successfully detects the human and fire at an unauthorised time and gives intimation. The results up to now are included in the paper.

REFERENCES

- [1] [https://en.wikipedia.org/wiki/Fault_\(technology\)](https://en.wikipedia.org/wiki/Fault_(technology))
- [2] https://en.wikipedia.org/wiki/Passive_infrared_sensor
- [3] <https://www.arduino.cc/projecthub/.../smoke-detection-using-mq-2-gas-sensor-79c54a>
- [4] <https://www.raspberrypi.org/>
- [5] <https://www.rhydolabz.com/wiki/>
- [6] <https://www.edaboard.com/thread/>