

# Fatigue and Design Analysis of Multi Leaf Spring

Rushikesh S Pande<sup>1</sup>, Dhanaji R Jadhav<sup>2</sup>, C S Kodarkar<sup>3</sup>

Lecturer, Department of Mechanical Engineering, Nutan Maharashtra Vidya Polytechnic, Talegaon, Pune,  
Maharashtra, India<sup>1</sup>

HOD, Department of Mechanical Engineering, Nutan Maharashtra Vidya Polytechnic, Talegaon, Pune,  
Maharashtra, India<sup>2</sup>

Assistant Professor, Department of Physics, Shri Siddheshwar Mahavidyalaya, Majalgaon, Beed,  
Maharashtra, India<sup>3</sup>

**ABSTRACT:** The suspension system of an automobile is required to withstand harsh working conditions while performing its function of absorbing shocks. The leaf spring of suspension system is subjected to cyclic stresses due to road undulations. In the present paper fatigue life of leaf spring is analysed. Fatigue failure of passenger vehicles leaf spring was reported during investigations carried out by sponsoring company. Existing leaf spring is analysed and tested experimentally. The leaf spring could not survive the test for specified life as per SAE 1528 standard. Alternate material EN47 is proposed for leaf spring with an aim to increase fatigue life. The leaf spring with EN47 was analysed to estimate fatigue life. Substantial increase in life cycles is observed by using EN47 as alternate material.

**KEYWORDS:** EN47, fatigue life, fatigue failure, leaf spring

## I. INTRODUCTION

Leaf springs are mainly used in automobile for absorbing shock energy as well as for restoring the initial position of chassis upon displacement. Every powered-vehicle has a provision for a suspension system which is crucial to the comfort of the passengers and for preventing damage to the goods being carried over the roadways. Since this function is directly related to comfort of the passengers and the also the goods-carrier for fragile materials or materials prone to spillage, it is desirable that the suspension system should continue to function in the best manner over the lifespan of the vehicle (typically 15 years). The number of shocks experienced by the vehicle along with its nature and magnitude influence the fatigue life of the leaf spring in the suspension system. Besides, any malfunction of the spring may lead to failure of connected parts in leaf spring assembly.

# International Journal of Innovative Research in Science, Engineering and Technology

(An ISO 3297: 2007 Certified Organization)

Website: [www.ijirset.com](http://www.ijirset.com)

Vol. 6, Issue 5, May 2017

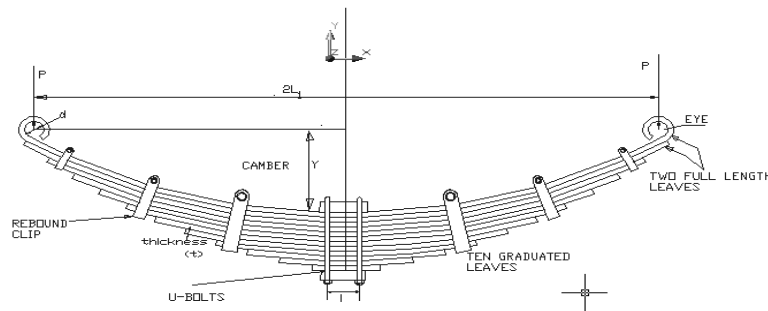

(a) Typical Leaf spring

In order to reduce the cost, weight reduction has been the main focus of automobile manufacturer in the present scenario. Weight reduction can be achieved primarily by the introduction of better material, design optimization and better manufacturing processes. The suspension leaf spring is one of the potential items for weight reduction in automobile. A long flat strip of spring steel forged into an arch and attached to the frame through a shackle assembly that permits changes in the effective length of the spring as it is compressed. To carry heavier load additional leaves can be stacked below the master leaf. This also provides a variable spring rate. Leaf spring of the suspension system of the passenger car, Maruti Van in present analysis shall withstand one million cycles of peak loading. Each leaf spring is expected to support a load of about 4000 N applicable for each wheel with deflection of the spring up to 40 mm at the hook end with 2-4 secs time for a typical cycle of loading. The suspension system of the vehicle has a series of leaf springs bound together as an assembly behaving like a unified component. The hooks are connected to the pivotal points of the chassis at both the ends. The entire weight of the chassis along with the other components of the vehicle over the chassis is borne by the leaf-spring. Typically, there are four leaf springs, each positioned near the axle end at each wheel. While the wheel rolls along the road, the leaf springs absorb the shock energy due to the unevenness of the road profile or any inconsistencies or discontinuities in its path (bump and pot-holes). The spring is subjected to cyclic loading due to these undulations with a maximum expected frequency of usage at about 500 cycles for peak loading a day. Considering the design life of this vehicle at 15 years, the spring should withstand a cyclic loading for tension and compression for around 3 million cycles.

## II. PROBLEM STATEMENT

Failure of leaf spring of Maruti Van was analysed by sponsoring company Advent Tool Tech Pvt. Ltd. Failures were categorized into four predominant modes. The data related to failure modes along with number of failures is presented in table (a)

609 failures were observed out of 40,000 vehicles released to the market during the period.

Warranty Claims (received till 31-Mar-2015)

Product/ Component Name and No. - Leaf Spring, Model No. AT2132

Period of assessment (for data) - April 2014 to March 2015

# International Journal of Innovative Research in Science, Engineering and Technology

(An ISO 3297: 2007 Certified Organization)

Website: [www.ijirset.com](http://www.ijirset.com)

Vol. 6, Issue 5, May 2017

Sr. No.	Description of physical region	No. of failures	% Failure
1	Deformity/twist in excess of 5 degrees over the individual length of the leaf.	226	37.1
2	Deformity/ Twist in excess of 3 degrees over the assembly.	188	30.9
3	Hair cracks or high order visual deformity.	106	17.4
4	Breakage due to crack/ Signs of Catastrophic failure	89	14.6
	Total	609	

Table (a)

## 2. Objectives

- Fatigue life estimation of existing leaf spring using classical method and finite element analysis software.
- Fatigue testing of leaf spring.
- Propose alternative design based on result analysis.
- Analysis of modified leaf spring.

## 3. Methodology

- Fatigue life of Existing leaf spring is estimated analytically by using Modified Goodman's equation and by FEMFAT software.
- Response of leaf spring subjected to cyclic loading is analysed experimentally.
- 50CrV4 Steel is selected as alternate material keeping same dimensions.
- Leaf spring with new material properties is analysed to estimate fatigue life.

## III. FATIGUE CALCULATIONS FOR LEAF SPRING

For calculating fatigue life of leaf spring Modified Goodman's Line equation has been considered. The material for the leaf spring is Medium Alloy Steel. Table (a) shows the chemical composition of medium alloy steel in percentage.

c	Mn	Si	Cu	Cr	Mo
0.2-0.4	0.5-1	0.3-0.6	0.6	0.4-0.6	0.15-0.3

Table (a)

# International Journal of Innovative Research in Science, Engineering and Technology

(An ISO 3297: 2007 Certified Organization)

Website: [www.ijirset.com](http://www.ijirset.com)

Vol. 6, Issue 5, May 2017

Table (b) shows the mechanical properties of the existing material (Medium alloy steel)

Sr. No.	Properties	Value (MPa)
1	Yield strength	338.8
2	Ultimate strength	621
3	Pulsating strength	500.3
4	Alternating strength	279.5

Table (b)

For determining fatigue life of leaf spring maximum stress ( $\sigma_{max}$ ) that can be applied is 440 MPa and minimum stress ( $\sigma_{min}$ ) is 0 MPa.

Design parameters used for fatigue life calculations are given in table (c)

Ka	Kb	Kc	Kd	Ke	Kf
0.8	1	1	1	1	1

Table (c)

The number of life cycles (N) that are obtained for leaf spring with medium alloy steel as a material is 54,981.

## 1. Finite element analysis of existing leaf spring.

To carry out FEM analysis of any component, the solid model of the same is essential. So the solid model of the leaf spring is required and this can be done in special CAD package like CATIA V5.

Fig (a) shows the modelling of leaf spring carried out by using Catia V5 Software and meshing is done in hyper mesh shown in fig. (b). There are three leaves including master leaf are having surface to surface contact.

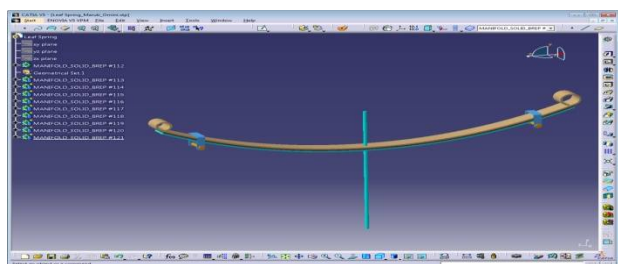

(a)

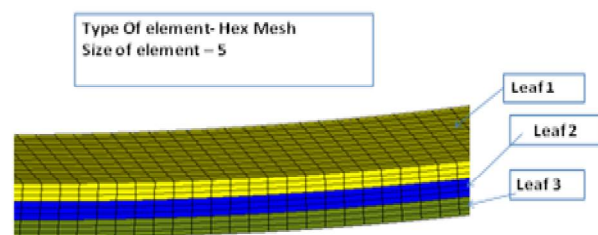

(b)

Quality Checks for Meshing

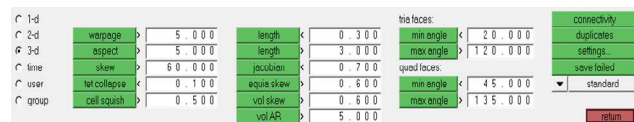

(c)

In Quality checks standard aspect ratio is 5, the aspect ratio obtained is 3.73 whereas standard warp age is 5 and obtained war page is 3.73. Quad face standard min. angle is 45 & obtained angle is 60 whereas standard max. Angle is 135 & obtained angle is 127.

## 2. Leaf Spring Analysis

Finite element analysis is used for obtaining results the displacement plot obtained as shown in fig (a). The maximum deflection of leaf spring is 145.38 mm at centre. Max shear stress obtained is 89.96 MPa as shown in fig. (b) and (c).

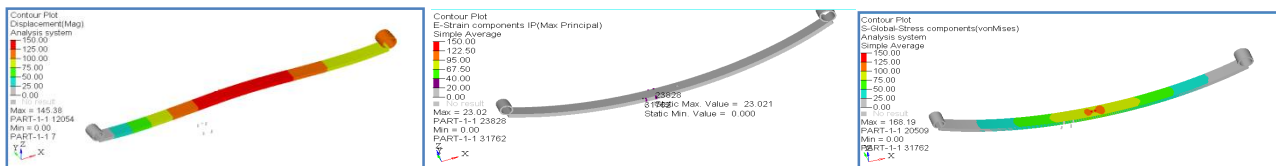

(a)

(b)

(c)

Fatigue analysis of existing leaf spring was done using FEMFAT solver. The life obtained is  $5 \times 10^4$  cycles. Shown in fig (d)

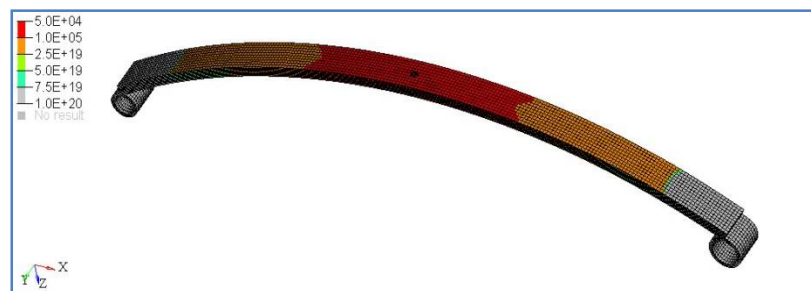

(d) Fatigue analysis of Medium alloy steel

## IV. EXPERIMENTAL VALIDATION

The standard or reference data available for the past design/ validation as standards or reference normally proves to be very useful while considering experimentation. The spring design once identified as suitable for the application would be subjected to trials for checking the fatigue life.

The experimentation is carried out and the spring is held in position with other operating conditions identical to the application. The trials are conducted in a very controlled environment with focus on the variables influencing the fatigue life. A fixed number of cycles (equivalent to one hour) shall be administered for checking the behaviour of the spring. As a future scope, this could be considered for extrapolating the results for deriving inference over the full life of the part. Fatigue test has been performed on the model and results that are obtained by experimental validation are shown in fig (a) and (b)

# International Journal of Innovative Research in Science, Engineering and Technology

(An ISO 3297: 2007 Certified Organization)

Website: [www.ijirset.com](http://www.ijirset.com)

Vol. 6, Issue 5, May 2017

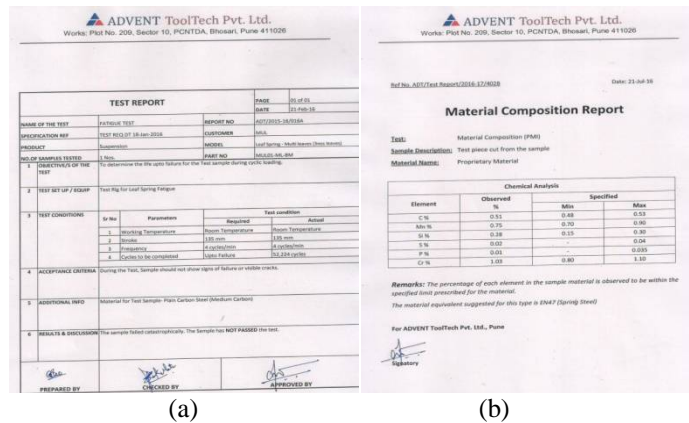

## V. MODIFICATION IN LEAF SPRING

As the given configuration of leaf spring has problem of premature failure. This failure may lead to loss of revenue and customer will. Thus configuration of leaf spring should be improved.

Following modifications are preferable for improving life of leaf spring.

- 1) To change the physical parameters.
- 2) To change the material.

The option for changing the physical parameters seems feasible in the industrial context. Following are the major physical parameters of leaf spring.

- 1) Span of the leaf spring.
- 2) Width of the leaf spring.
- 3) Thickness of the leaf.
- 4) Number of leaves.

The behaviour of the component mainly depends on the material properties. The main purpose of doing this paper work is to increase life of leaf spring. Changing the material of leaf spring with another material having higher yield strength can lead to improvement in the fatigue life of leaf spring.

So the alternate material selected for leaf spring is EN47. It is a tough oil quenching spring steel which when heat treated offers good wear resistance.

### 1. Design calculations of Modified Leaf Spring

The modified material for leaf spring is EN47. To analyse the life of leaf spring analytically Modified Goodman's line equation is used. Table (a) shows the chemical composition of modified material (EN47) in percentage.

c	Mn	S	P	Cr	Si
0.55-0.65	0.75-1	0.04	0.035	0.70-0.90	0.15-0.35

Table (a)

# International Journal of Innovative Research in Science, Engineering and Technology

(An ISO 3297: 2007 Certified Organization)

Website: [www.ijirset.com](http://www.ijirset.com)

Vol. 6, Issue 5, May 2017

Table (b) shows the mechanical properties of modified material (EN47)

Sr. No.	Properties	Value (MPa)
01	Yield Strength	455.1
02	Ultimate Strength	880
03	Pulsating Strength	655.7
04	Alternating Strength	398.8

Table (b)

For determining fatigue life of leaf spring maximum stress ( $\sigma_{max}$ ) that can be applied is 440 MPa and minimum stress ( $\sigma_{min}$ ) is 0 MPa.

Design parameters used for fatigue life calculations are given in Table (c)

Ka	Kb	Kc	Kd	Ke	Kf
0.8	1	1	1	1	1

Table (c)

The number of life cycles (N) that are obtained for leaf spring with modified material (EN47) is 13, 54,982.

## 2. Fatigue Analysis of Modified Leaf Spring

The material of leaf spring has been modified and fatigue analysis has been carried out in the same steps as that have performed for existing leaf spring. Finite element analysis had been carried out and maximum deflection of the spring obtained is 145.38 mm shown in fig (a) and the value of maximum stress obtained by FEM is 961.12 MPa shown in fig (b).

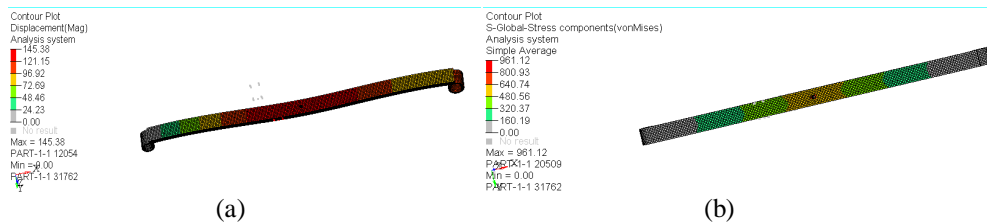

The number of life cycles obtained is  $1 \times 10^6$ . FEMFAT software has been used for obtaining life cycles. The numbers of life cycle obtained are greater than that of earlier material that was medium alloy steel.



# International Journal of Innovative Research in Science, Engineering and Technology

(An ISO 3297: 2007 Certified Organization)

Website: [www.ijirset.com](http://www.ijirset.com)

Vol. 6, Issue 5, May 2017

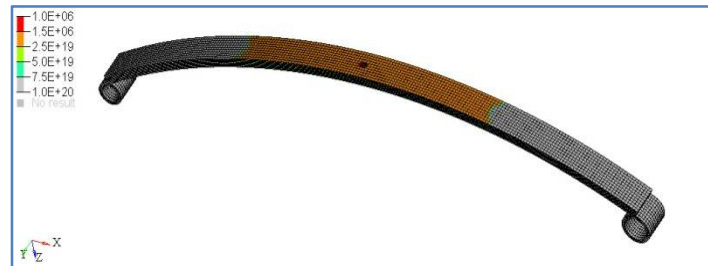

(c)

## VI. RESULT AND DISCUSSION

When Benchmark material (Medium alloy steel) is considered then fatigue life in terms of number of cycles is 50,000 cycles. Then in this case there may be chances of failure of spring. To improve the life of leaf spring it may be possible to make changes in dimension as well as in material. Material change has been taken into consideration so that life of spring will be improved to 10, 00,000 cycles.

Sr. No.	Variant number	Description	Fatigue life	Remarks
1	Existing leaf spring	Existing Design Medium alloy steel	50,000 cycles	Early failure
2	Modified leaf spring	Material Change (EN47) Incorporated in design.	10,00,000 cycles	Compliance with design life

Table (a)

## VII. CONCLUSION

- The use of EN47 has enhanced the fatigue life about twenty fold for their case ( 10 lac cycles against 0.5 lac for conventional material )
- Longer service life leads to lower maintenance cost.
- Extended mode of utility over different terrain of transport.
- Lower indirect cost incurred due to catastrophic failure.
- Improvement in ride quality due to better shock absorbing capability.
- Use of EN47 may lead to increase of cost of material.(about 10% in raw material cost)

## REFERENCES

1. M.A. Osipenko, Yu.I. Nyashin, R.N. "A contact problem in the theory of leaf spring bending" International Journal of Solids and Structures 40 (2003) 3129–3136
2. A. González Rodríguez a, J.M. Chacón b, A. Donoso c, A.G. González Rodríguez d. "Design of an adjustable-stiffness spring: Mathematical modelling and simulation, fabrication and experimental validation "mechanism and machine theory 46 (2011) 1970–1979
3. F.T. Rowland, *Manual on Design and Application of Leaf Springs*—SAE HS J788, Society of Automotive Engineers (SAE), Warrendale, PA, 1980.
4. N.J. Nigro, S.P. Bhatia, *Equivalent one-dimensional system for analysis of taper leaf springs*, ASME J. Engrg Ind. 98 (Series B) (1976) 39–42.



# International Journal of Innovative Research in Science, Engineering and Technology

(An ISO 3297: 2007 Certified Organization)

Website: [www.ijirset.com](http://www.ijirset.com)

Vol. 6, Issue 5, May 2017

5. B.I. Dunaevskii, *Calculation of solid beams and flat springs (leaf springs) of varying cross-section*, Sov. Engrg. 36–38 Res. 61 (1981)
6. W.F. Milliken, D.L. Milliken, *Chassis Design: Principles and Analysis*, Society of automotive Engineers (SAE), Warrendale, PA, 2002.
7. G.Rill, N. Kessing, O. Lange, J. Meier, *Leaf Spring Modelling for Real Time Applications*, Proceedings of International Association of Vehicle System Dynamics (IAVSD) 18th Symposium, Atsugi, Japan, 2003.
8. E. Zahavi, *Analysis of a contact problem in leaf springs*, Mech. Res. Commun 19 (1992) 21–27.
9. Q. Li, W. Li, *a Contact finite element algorithm for the multileaf spring of vehicle suspension systems*, IMEC-E Part D: J. Autom. Engrg. 218 (2004)305–314.
10. M.A. Omar, A.A. Shabana, A. Mikkola, W. Loh, R. Basch, *Multibody system modelling of leaf springs*, J. Vib. Contr. 10 (2004) 1601–1638.
11. A.A. Shabana, *Dynamics of Multibody Systems*, Second ed., Cambridge University Press, Cambridge, 1998.
12. J.S. Przemieniecki, *Theory of Matrix Structural Analysis*, McGraw-Hill, NY, 1968.
13. Y.A. Khulief, A.A. Shabana, *A continuous force model for the impact analysis of flexible multibody systems*, Mech. Mach. Theory 22 (1987) 213–224.
14. H.B. Pacejka, *Tire and Vehicle Dynamics*, Society of Automotive Engineers (SAE), Warrendale, PA, 2002. Vehicle Dynamics Terminology SAE J670e, 1978, Society of Automotive Engineers (SAE).
15. G.Gim, P.E. Nikraves, *An analytical model of pneumatic tires for vehicle dynamic simulations. Validation against experimental data*, Int. J.Vehicle 217–228. Des. 12 (1991)
16. J. Klaps, A.J. Day, *Steering drift and wheel movement during braking: parameter sensitivity studies*, IMEC-E Part D: J. Autom. Engrg. 1107–1115. 217 (2003)
17. L.F. Shampine, M.K. Gordon, *Computer Solution of Ordinary Differential Equations*, W.H. Freeman, San Francisco, 1975.
18. V.B.Bhandari, (2008), *Design of machine elements*, Tata Mc Graw-Hill.
19. Shigley's *Mechanical Engineering Design* Tata Mc Graw-Hill.
20. HYPERMESH 10, user manual.