

# AC-DC-AC 3 Level PWM Converter

Sindhu B M<sup>1</sup>, Vidyashree MS<sup>2</sup>, Chaitrashree SR<sup>3</sup>

Assistant Professors, Department of EEE, GSSSIETW, Mysuru, Karnataka, India

**ABSTRACT:** In this paper, ac-dc-ac 3-level neutral point converter using pwm, is supplied by unbalanced and/or distorted grid voltage is proposed. The main objective of the control scheme is to obtain balanced and sinusoidal output current with unity power factor under non ideal voltage supply [2] the modified direct power control is used based on the elimination of undesired terms in active and reactive powers resulting from unbalanced and harmonically distorted voltage supply.

**KEYWORDS:** pwm- pulse width modulation, igt-insulated gate bipolar transistor, pwm controller.

## I. INTRODUCTION

Three-phase AC/DC/AC pulse-width modulation (PWM) converters have been widely used in recent years due to their low line current distortion and high power factor. The application of multilevel converters brings further advantages,[1]Higher voltage output with the same device rating, lower harmonic content, and reduced converter losses. However, the presence of an unbalance and/or harmonics in the voltage supply creates undesired pulsation terms in the output DC-link voltage.[2]The proposed method improves direct power control with space vector modulation (DPC-SVM) applied for a 3-level 3-phase AC/DC/AC neutral point clamped rectifier to achieve constant commutation frequency. The proposed PWM controller also ensures voltage balance in DC-link capacitors using redundant vectors in the Space Vector Modulation block without the need of additional components.

Pulse width modulation (PWM) is a powerful technique for controlling analog circuits with a microprocessor's digital outputs. PWM is employed in a wide variety of applications, ranging from measurement and communications to power control and conversion[6]. It is a very efficient means of controlling electrical power because the controlling element (the power transistor) dissipates comparatively little power in switching on and off, especially if compared to the wasted power dissipated of a rheostat in a similar situation.

### 1.1 PULSE WIDTH MODULATION

PWM is a powerful technique for controlling analog circuits with a microprocessor's digital outputs. PWM is employed in a wide variety of applications, ranging from measurement and communications to power control and conversion. Controlling electrical power through a load by means of quickly switching it on and off, and varying the "on" time, is known as *pulse-width modulation*, or *PWM*. It is a very efficient means of controlling electrical power because the controlling element (the power transistor) dissipates comparatively little power in switching on and off, especially if compared to the wasted power dissipated of a rheostat in a similar situation. When the transistor is in cutoff, its power dissipation is zero because there is no current through it.

# International Journal of Innovative Research in Science, Engineering and Technology

(An ISO 3297: 2007 Certified Organization)

Website: [www.ijirset.com](http://www.ijirset.com)

Vol. 6, Issue 5, May 2017

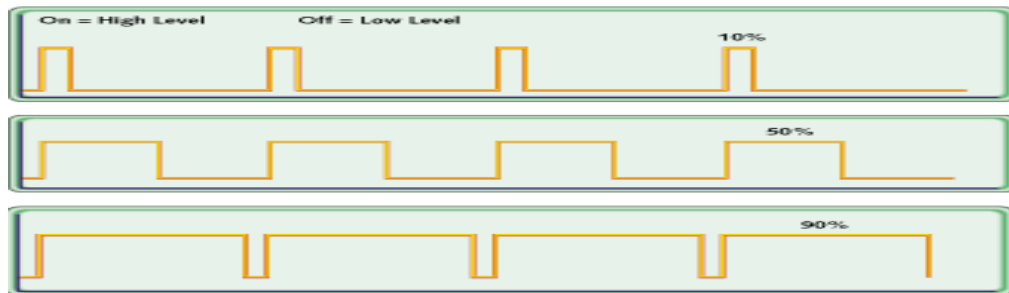

fig 1.1 Three different PWM signals of AC input signal.

For example, the supply is 9V and the duty cycle is 10%, a 0.9V analog signal results in DC signal output as given above.

## 1.2 ANALOG CIRCUITS

An analog signal has a continuously varying value, with infinite resolution in both time and magnitude. Analogue electronics (also spelled analog electronics) are electronic systems with a continuously variable signal, in contrast to digital electronics where signals usually take only two levels. The term "analogue" describes the proportional relationship between a signal and a voltage or current that represents the signal. The signals take any value from a given range, and each unique signal value represents different information. Any change in the signal is meaningful, and each level of the signal represents a different level of the phenomenon that it represents. Another method of conveying an analogue signal is to use modulation. In this, some base carrier signal has one of its properties altered: amplitude modulation (AM) involves altering the amplitude of a sinusoidal voltage waveform by the source information, frequency modulation (FM) changes the frequency. Other techniques, such as phase modulation or changing the phase of the carrier signal, are also used.

Analogue systems invariably include noise that is random disturbances or variations, some caused by the random thermal vibrations of atomic particles. Since all variations of an analogue signal are significant, any disturbance is equivalent to a change in the original signal and so appears as noise. As the signal is copied and re-copied, or transmitted over long distances, these random variations become more significant and lead to signal degradation. Other sources of noise may include crosstalk from other signals or poorly designed components. These disturbances are reduced by shielding and by using low-noise amplifiers (LNA).

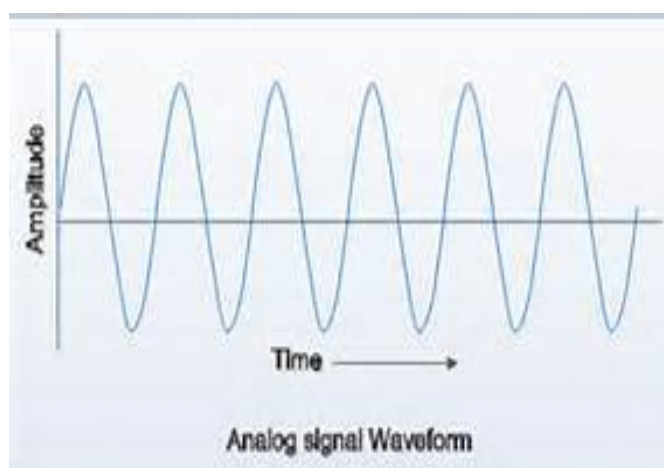

Fig 1.2 Analogue electronic circuits.

## International Journal of Innovative Research in Science, Engineering and Technology

(An ISO 3297: 2007 Certified Organization)

Website: [www.ijirset.com](http://www.ijirset.com)

Vol. 6, Issue 5, May 2017

### 1.3 DIGITAL CONTROL

By controlling analog circuits digitally, system costs and power consumption can be drastically reduced. What's more, many microcontrollers and DSPs already include on-chip PWM controllers, making implementation easy. PWM is a way of digitally encoding analog signal levels. Through the use of high-resolution counters, the duty cycle of a square wave is modulated to encode a specific analog signal level. The PWM signal is still digital because, at any given instant of time, the full DC supply is either fully on or fully off. The on-time is the time during which the DC supply is applied to the load, and the off-time is the period during which that supplies is switched off. Given a sufficient bandwidth, any analog value can be encoded with PWM.

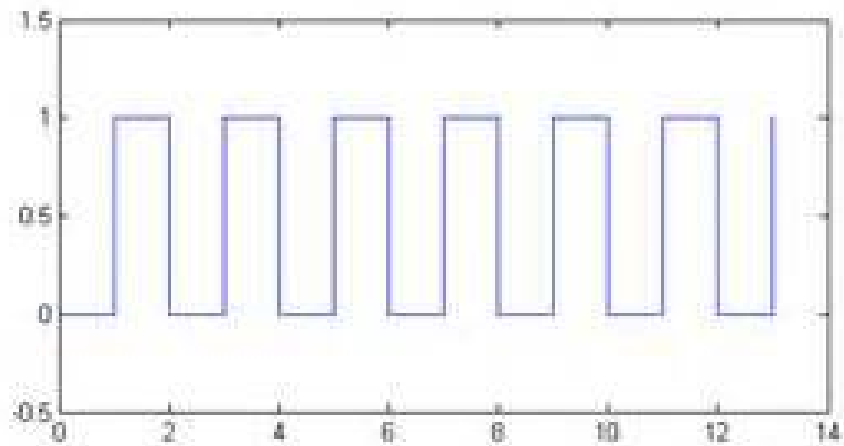

fig 1.3 Digital waveforms.

### 1.4 ANALOG V/S DIGITAL CIRCUITS:

Analog circuits and digital circuits are one way of classifying electronic circuits. The concept of analog versus digital is a very important concept discussed in physics, engineering, electronics, computing, instrumentation, mathematics and various other fields. In this article, we are going to discuss what analog circuits and digital circuits are, and the difference between analog circuits and digital circuits.

Analog refers to circuits in which quantities such as voltage or current vary at a continuous rate. When you turn the dial of a potentiometer, for example, you change the resistance by a continuously varying rate. The resistance of the potentiometer can be any value between the minimum and maximum allowed by the pot.

If you create a voltage divider by placing a fixed resistor in series with a potentiometer, the voltage at the point between the fixed resistor and the potentiometer increases or decreases smoothly as you turn the knob on the potentiometer.

In digital electronics, quantities are counted rather than measured. There's an important distinction between counting and measuring. When you count something, you get an exact result. When you measure something, you get an approximate result.

In one sense, digital circuits are more accurate because they count with complete precision. But its not same in case of analogue circuits.

On the other hand, digital circuits are inherently limited in their precision because they must count in fixed units. Most digital thermometers, for example, have only one digit to the right of the decimal point. Thus, they can indicate a temperature of 98.6 or 98.7 but can't indicate 98.65.

Here are a few other thoughts to ponder concerning the differences between digital and analog systems:

# International Journal of Innovative Research in Science, Engineering and Technology

(An ISO 3297: 2007 Certified Organization)

Website: [www.ijirset.com](http://www.ijirset.com)

Vol. 6, Issue 5, May 2017

- Saying that a system is digital isn't the same as saying that it's binary. Binary is a particular type of digital system in which the counting is all done with the binary number system. Nearly all digital systems are also binary systems, but the two words aren't interchangeable.
- Many systems are a combination of binary and analog systems. In a system that combines binary and analog values, special circuitry is required to convert from analog to digital, or vice versa. An input voltage (analog) might be converted to a sequence of pulses, one for each volt; then the pulses can be counted to determine the voltage.

## 1.5 HARMONICS

Non-sinusoidal complex waveforms are constructed by adding together a series of sine wave frequencies known as Harmonics. Harmonics is the generalized term used to describe the distortion of a sinusoidal waveform by waveforms of different frequencies.

In an electrical or electronic device or circuit that has a voltage-current characteristic which is not linear, that is, the current flowing through it is not proportional to the applied voltage. The alternating waveforms associated with the device will be different to a greater or lesser extent to those of an ideal sinusoidal waveform. These types of waveforms are commonly referred to as non-sinusoidal or complex waveforms.

Complex waveforms are generated by common electrical devices such as iron-cored inductors, switching transformers, electronic ballasts in fluorescent lights and other such heavily inductive loads as well as the output voltage and current waveforms of AC alternators, generators and other such electrical machines. The result is that the current waveform may not be sinusoidal even though the voltage waveform is.

Also most electronic power supply switching circuits such as rectifiers, silicon controlled rectifier (SCR's), power transistors, power converters and other such solid state switches which cut and chop the power supplies sinusoidal waveform to control motor power, or to convert the sinusoidal AC supply to DC. These switching circuits tend to draw current only at the peak values of the AC supply and since the switching current waveform is non-sinusoidal the resulting load current is said to contain **Harmonics**

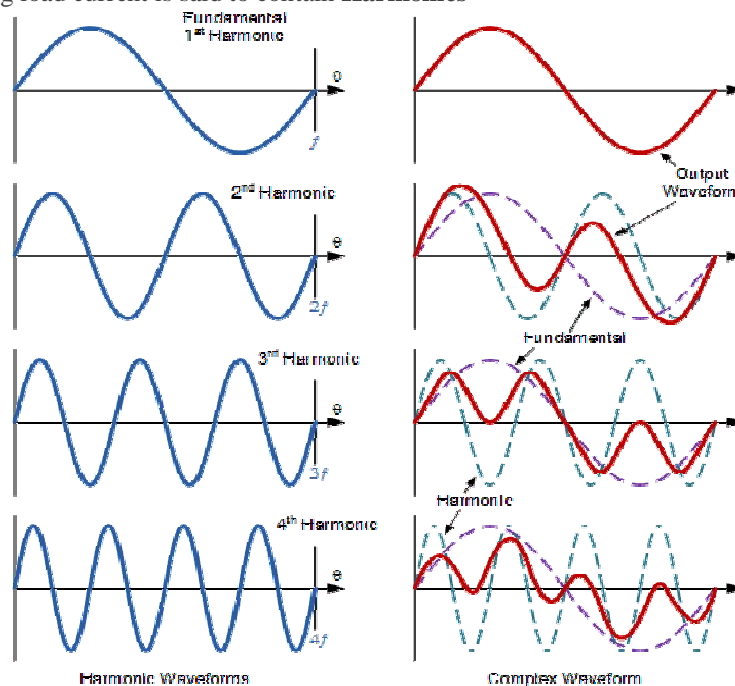

fig 1.5 Harmonic waveforms.

# International Journal of Innovative Research in Science, Engineering and Technology

(An ISO 3297: 2007 Certified Organization)

Website: [www.ijirset.com](http://www.ijirset.com)

Vol. 6, Issue 5, May 2017

## II. PROPOSED METHODOLOGY

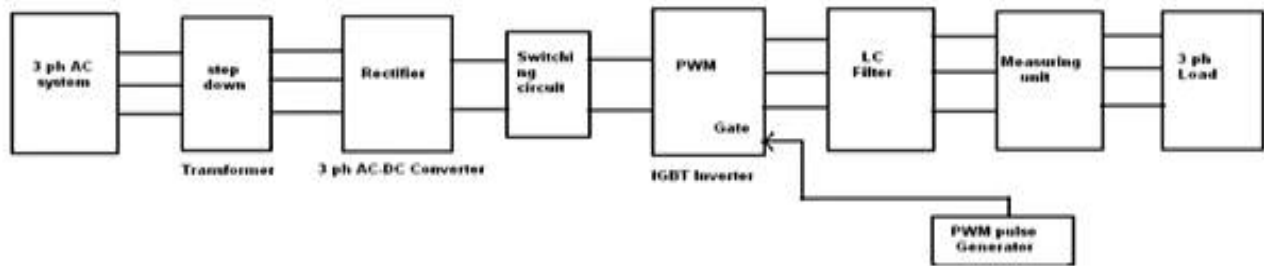

Fig.2.1. Block diagram of AC-DC-AC PWM CONVERTER

A 3-phase ac supply is given to the three phase step down transformer, where voltage gets reduced, which is given to the rectifier circuit, converts AC to DC and further this dc voltage is given to PWM IGBT converter which converts DC to AC also eliminates lower order harmonics, this ac voltage is fed to LC filter to reduce the higher order harmonics[2]. Finally, the output voltage and current is measured using measuring circuit and connected to 3 phase load. Here, the output voltage is compared with the reference voltage in the voltage regulator and the difference between the two voltages is nothing but error which is generated by PWM pulse generator and given back to the converter.

### ADVANTAGES OF PROPOSED SCHEME

- The output voltage control is obtained without any additional components
- Lower order harmonics can be eliminated with its output voltage control

## III. SIMULATION

### AC-DC-AC PWM Converter

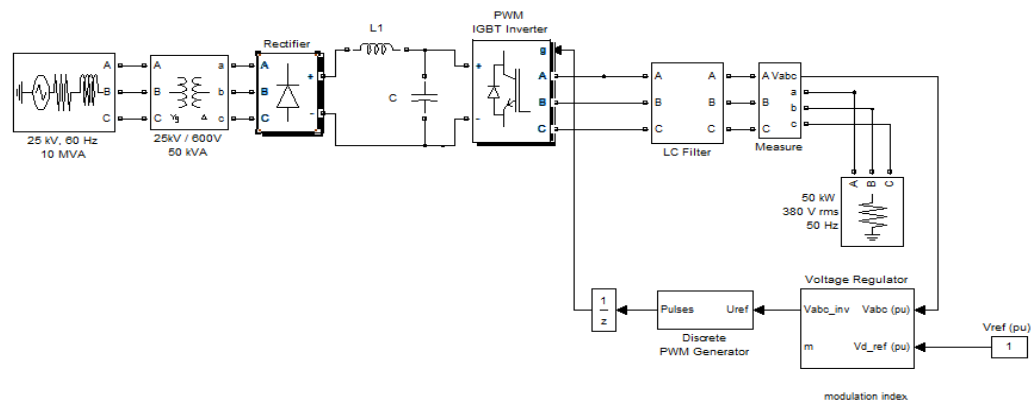

Fig.2.2 Proposed Methodology

A 25KV 60 Hz, voltage source feeds a 50 Hz, 50 kW load through an AC-DC-AC converter. The 600V, 60 Hz voltage obtained at secondary of the star delta transformer is given to rectifier circuit which gives dc output voltage. The filtered DC voltage is applied to an IGBT two-level inverter generating 50 Hz. The IGBT inverter uses

## International Journal of Innovative Research in Science, Engineering and Technology

(An ISO 3297: 2007 Certified Organization)

Website: [www.ijirset.com](http://www.ijirset.com)

Vol. 6, Issue 5, May 2017

Pulse Width Modulation (PWM) at a 2 kHz carrier frequency[4][5]. The circuit is discretized at a sample time of 2 us. The load voltage is regulated at 1 pu (380 V rms) by a PI voltage regulator.

The first output of the voltage regulator is a vector containing the three modulating signals used by the PMW Generator to generate the 6 IGBT pulses. The second output returns the modulation index. The Discrete 3-Phase PWM Pulse Generator is available in the Discrete Control Blocks library. The voltage regulator has been built from blocks of the Extras/Measurements and Extras/ Discrete Control libraries[3][6][1]. The ac output voltage obtained from IGBT converter is passed to LC filter to remove higher order harmonics .The Multimeter block is used to observe diode and IGBT currents. In order to allow further signal processing, signal.Start the simulation. After a transient period of approximately 50 ms, the system reaches a steady state. Observe voltage waveforms at DC bus, inverter output and load on Scope1. The harmonics generated by the inverter around multiple of 2 kHz are filtered by the LC filter.

### IV.RESULT & DISCUSSION

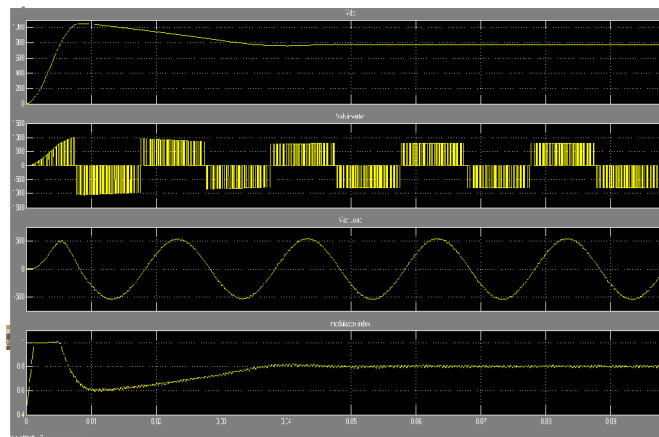

Fig 3.simulation result of Wm in rpm, Tin N-m,I in mA, PWM signal

It can be inferred that higher harmonics content at lower voltage can be reduced significantly by using several pulses of equal width at each half cycle ,thus the rms value of the output voltage of the inverter depends upon pulse width in turn modulation index 'm'.

The advantages of using specified components are as follows:

#### IGBT

- It's a voltage control device, hence the drive circuit is very simple
- On state losses are reduced
- No commutation circuits are required
- It acts as a harmonic compensator

#### LC Filters

- In low pass LC filters the inductance offers a high impedance to harmonic voltage
- Higher the harmonic number, higher will be the impedance and lower will be the magnitude of output voltage
- Capacitance offers shunt path for the harmonic current.
- Higher the frequency, lower will be the  $X_c$  and more harmonic current will be bypassed[4]

# International Journal of Innovative Research in Science, Engineering and Technology

(An ISO 3297: 2007 Certified Organization)

Website: [www.ijirset.com](http://www.ijirset.com)

Vol. 6, Issue 5, May 2017

## V. CONCLUSION

The main objective is achieved, reducing harmonics and ripples during transmission. This approach provides fast synchronous-rectifier, adjustment, robustness to disturbance and the capability to simultaneously optimize multiple parameter.

## REFERENCES

1. L. Malesani and P. Tenti, "A Novel Hysteresis Control Method for Current-Controlled Voltage-Source PWM Inverters with Constant Modulation Frequency", IEEE Trans. Ind. Appl. Vol. 26, No.1, Jan./Feb. 1990, pp. 88-92.
2. L. Malesani, P. Tenti, E. Gaio and R. Piovon, "Improved Current Control Technique of VSI PWM Inverters with Constant Modulation Frequency and Extended Voltage Range", IEEE Trans. Ind. Applic., Vol. 27, NO. 2, Mar./Apr. 1991, pp. 365-369.
3. V.Blasko and V.kaura, "a new model and control of a three phase AC –DC voltage source converter, IEEE Transaction on power electronics,volume.12,no.1,19997,pp.116-123.doi;10.1109/63.554176
4. H.Komurcugil and o.kukrer, "Lyapunov-based control for three-phase PWM AC /DC voltage –source converter",IEEE transaction on power electronics,vol.13,NO.5,1998,pp.801-813.doi;10.1109/63.712278.
5. Y.Ye.,M.kazerani and V.H Quintana. "modeling.control and implementation of three phase PWM converters, "IEEE Transaction on power electronic,vol.18,No.3,pp.857-864,2003.
6. J.R.Rodioues,J.W.Dixon,J.R.espinoza,J.pontt and p.lezana, "PWM Regenerative rectifiers:state of art, "IEEE Transaction on industrial electronics,vol.52,No.1,2005,pp.5-22.doi:10.1109/TIE.2004.841149.
7. M.Liserre,R. Teodorescu and F.Blaabjera. "Multiple harmonics control for three phase grid converter system, "IEEE Transactions on power electronics,vol.21,No.3,2006,pp.836-841,doi:10.1109/TPEL.2006.875566
8. J.W.Kolar,T.Friedli,f.rismer,S.D.ROUND, "The essence of three phase AC/DC Converter system.", Proceedings of the 13<sup>th</sup> power electronics.pp.27-42,sept,1-3,2008.