

International Journal of Innovative Research in Science, Engineering and Technology

(An ISO 3297: 2007 Certified Organization)

Website: www.ijirset.com

Vol. 6, Issue 5, May 2017

Value Stream Mapping of Front Axle Beam for Heavy Commercial Vehicle

Ajinkya Bhosale¹, Swapnil Yemle², Trupti Jadhav³, Kiran Maddewad⁴, Nilesh Jadhav⁵

U.G. Student, Department of Mechanical Engineering, ABMSP'S APCOER, Parvati, Pune, India^{1,2,3,4}

Assistant Professor, Department of Mechanical Engineering, ABMSP'S APCOER, Parvati, Pune, India⁵

ABSTRACT: In order to remain competitive in global market, many manufacturing companies have implemented Value Stream Mapping (VSM), which is a qualitative Lean Manufacturing method for elimination of non-value added activities and operational process improvements. VSM is a map of current and future state of a production system that analyses value added and non-value added parameters from current state and reconfigures the process to eliminate the waste. The goal of this research paper is to design an efficient Value Stream Mapping (VSM) to improve the production line of Front Axle Beam for heavy commercial vehicle. The methodology of the study was to draw a current state map by identifying the areas of improvement & production waste and further apply the Kaizen activity to effectively design future state map for process improvement. Based on future VSM, final results showed that Production-Lead-time (PLT) decreased from 170.14 min to 142.76 min per day and the value added time decreased from 14.047 min to 12.467 min per day.

KEYWORDS: Front Axle Beam, Value stream mapping (VSM), Lean manufacturing, Kaizen activity, Takt time, Non-value added parameter, lead time.

I. INTRODUCTION

The most critical issue faced by manufacturers in today's global market is how to deliver their products or materials quickly at low cost and good quality. Several methods and approaches exist such as computer simulation, statistical analysis, and lean tools for improving the efficiency and productivity by determining the best combination of resources in production lines, construction process, energy, services and supply chains. In production plants across the globe, lean manufacturing techniques are being used to meet increasing demands placed on manufacturers. The core idea behind lean manufacturing techniques is maximizing customer value while minimizing waste, thereby achieving manufacturing excellence through the creation of more value with fewer resources. Through the elimination of waste along the entire manufacturing process, rather than at isolated points, companies are able to create processes that need less human effort, less space, less capital, and less time to produce high-quality, lower-cost products compared with traditional manufacturing systems. There are seven elements in identifying waste in overproduction, inventory, transportation, waiting, motion, over-processing and correction. Value Stream Mapping, which is a significant lean manufacturing tool, can be defined as the process of flow sketch of added and non-added value parameters in producing products ranging from raw materials up to goods produced to deliver products to customer. The information flow particularly for production lead time is also identified as VSM also focuses on the product value stream. The present research work of value stream mapping of front axle beam for heavy commercial vehicle is carried out in XYZ manufacturing company located at Pune. The current state mapping is done by observation and recording of requisite data across the production line and further discussion with concerned personnel's. Based on current state mapping data, action plan for future state mapping was outlined.

International Journal of Innovative Research in Science, Engineering and Technology

(An ISO 3297: 2007 Certified Organization)

Website: www.ijirset.com

Vol. 6, Issue 5, May 2017

II. LITERATURE SURVEY

- 1) The paper “Facility layout for SME Food Industry via Value Stream Mapping and simulation” concluded that Value Stream Mapping provides the model and data that will make simulation becomes easier to be done. In this paper, this combination will improve the facility layout for that company. By comparing the flow diagrams of the current production process and the new proposed process, it is shown that the distance between workstation and the process time is substantially reduced.
- 2) The paper “Designing a Future Value Stream Mapping to Reduce Lead Time Using SMED” has shown the implantation of Value stream mapping in PCB assembly line to reveal obvious and hidden waste that affected the productivity of smart tag production. The SMED technique was implemented at the insertion process that was bottleneck. This study recommends that the insertion process might be converted from batch operation to continuous flow operation to reduce more wastes.
- 3) “Quality Value Stream Mapping” paper gives brief idea about procedure model which consist of four consecutive phases: preparation, quality value stream analysis, quality value stream design and implementation. Moreover, the quality-related costs of the production line are illustrated.

III. METHODOLOGY

VSM methodology includes five major steps, in which the initial four are all leading up to the actual improvement of the process.

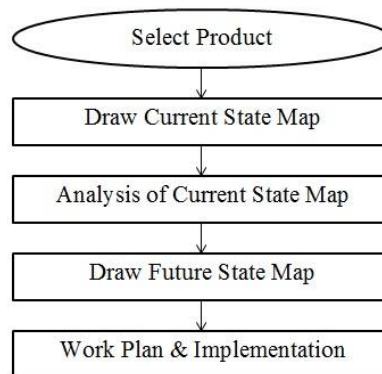

Fig.1: Implementation of steps in value stream mapping

1. Identifying Product Families

First step is identifying product families of front axle beams of diverse size and shapes by matrix methods and then selecting one part family over all other product families. Generally, total work content for producing one part should be within 25 to 30 % (range) of all other different parts in one product family.

2. Draw Current State Map

Then current state map is drawn based on data collected by observation and recordings across the production line. Data is collected by using stopwatch.

International Journal of Innovative Research in Science, Engineering and Technology

(An ISO 3297: 2007 Certified Organization)

Website: www.ijirset.com

Vol. 6, Issue 5, May 2017

3. Analysis of Current State Map

The drawn current state map helps to identify value added and non-value added parameters like wastage, waiting, inventory, lead time, cost efficiency, quality etc. in the production line. Then each parameter is analysed to find scope for improvement on each step of process to draw future state map.

4. Draw Future State Map

The future state map is drawn to eliminate non-value added parameters identified in the current state map and to improve process operations. The kaizen technique is applied for this continuous improvement.

5. Implement Future State

The research findings were suggested to the management so as to be incorporated in the action work plan and further implemented for production improvement.

IV. CURRENT STATE MAPPING

The current state map is done with paper and pencil using different VSM symbols to give a pictorial view of information and material flow as product moves through production line. The flow process for manufacturing front axle beam in XYZ Company is as follows:

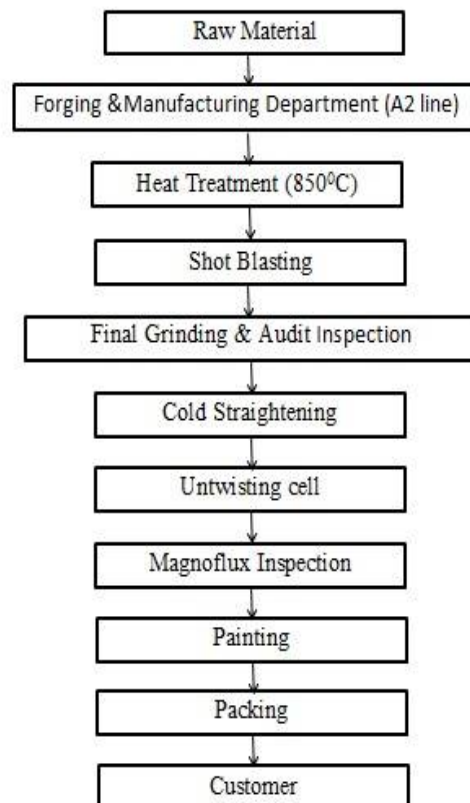

Fig.2: Manufacturing Process of Front Axle Beam.

International Journal of Innovative Research in Science, Engineering and Technology

(An ISO 3297: 2007 Certified Organization)

Website: www.ijirset.com

Vol. 6, Issue 5, May 2017

The current state map drawing of front axle beam involves the following steps.

1. Calculate Takt Time

Takt time is defined as net available time divided by customer demand. The net available time is the total operation time during a specific period, meaning the total amount of time, which adds value on value stream. Customer Demand can be determined on customer forecast or based on the currently customer order.

2. Understand customer demand

Customer demand for front axle is monthly based in the present company. It is 30000 axle beams per month (appx 1000 per day).

3. Map the process flow

This step involves various processes to complete the product. In addition, measure relevant data to put in a value stream mapping box. The work data in process between two value stream maps is recorded.

4. Map the material flow

The flow of material from raw material to finished goods is given by supplier to customer.

5. Map the information flow

The demand information flow is given is given electronically or manually.

6. Draw the Time line

Calculate production lead times for inventory triangles by dividing quantity of inventory by the customer daily requirements.

The VSM of Front axle beam requires calculating the different timings in flow process using the following formulae:

1. Cycle time = Machine cycle time
2. Process time = (Loading/Unloading time) + cycle time
3. TAKT time = Available time/Customer Demand
4. Total Production cycle time = Value added time + Non value added time
5. Non-value added time = (Total inventory/Total demand) * 21.5 * 60
6. Process ratio = Value added time / Total Production cycle time

Figure 3, shows Current VSM by adding timeline at bottom of the map to calculate the Lead time and the value added time.

International Journal of Innovative Research in Science, Engineering and Technology

(An ISO 3297: 2007 Certified Organization)

Website: www.ijirset.com

Vol. 6, Issue 5, May 2017

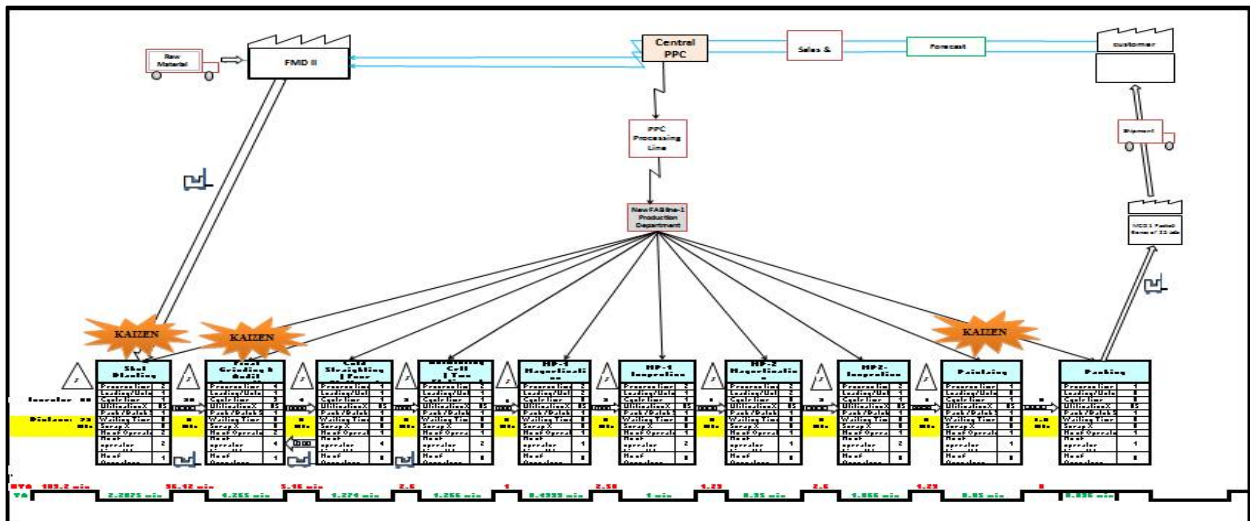

Fig.3: Current Value State Map

V. FUTURE STATE MAP

After detailed analysis of drawn current state map, improvement areas were identified using kaizen bursts which lead to reduce process time as shown in Figure 4. The Future State Map can be shaped to guide the positive changes that are desired for the future. It also includes essential actions to continuously improve the project. The future state map is drawn to give proposed suggestions and recommendations for improvement in the current position of the company. The future state map below shows all the areas that require improvement and the ways it can be improved.

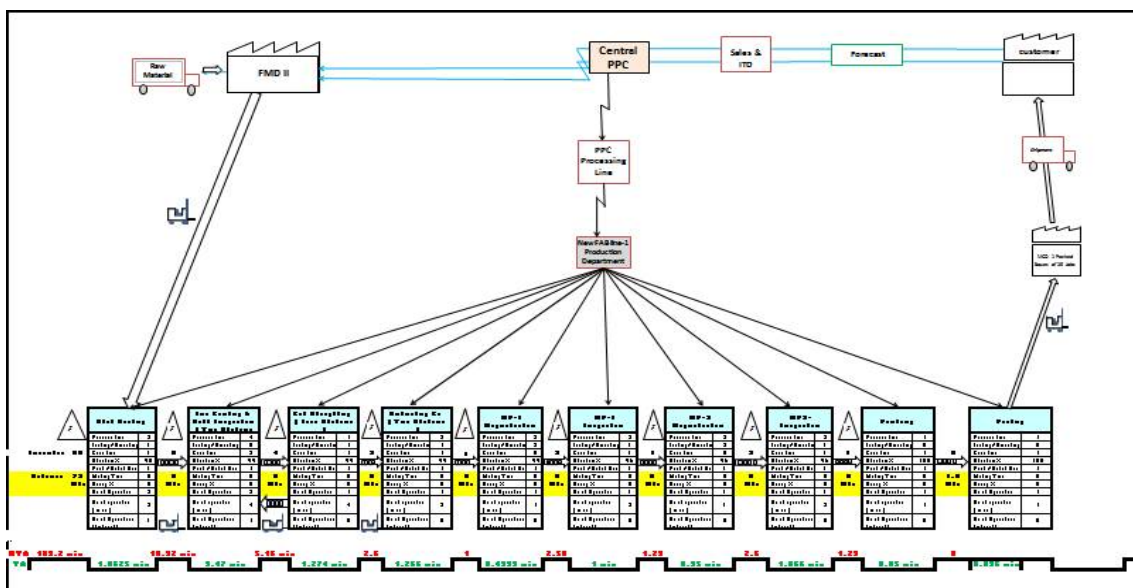

Fig.4: Future State Map

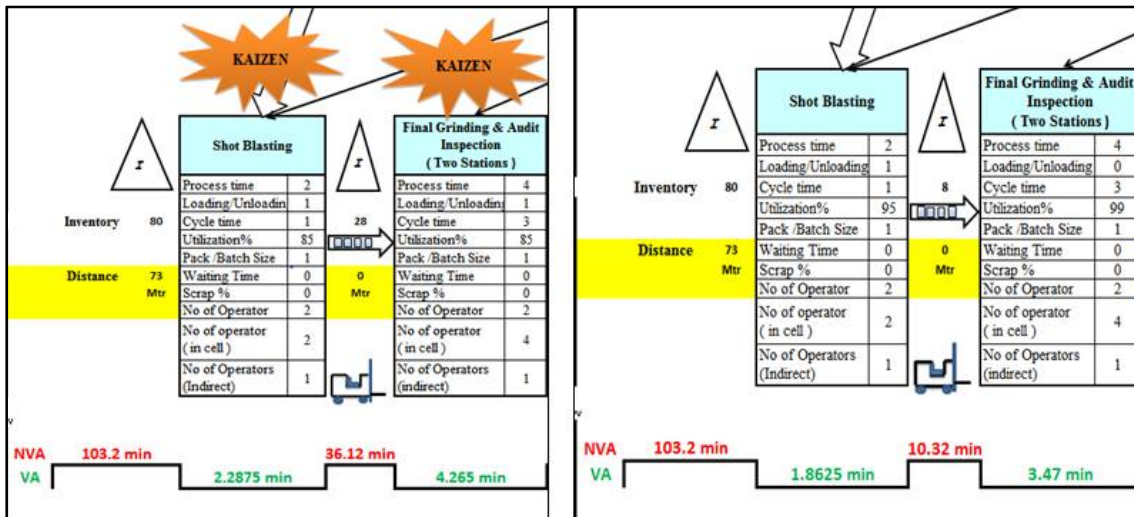
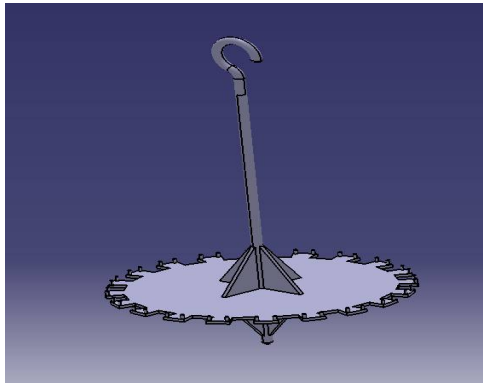



Fig.5: a) zoom-in view of Current state VSM. b) zoom-in view of Future state VSM

VI. COMPARISON OF CURRENT & FUTURE VSM IN PROCESS SYSTEM



Process	Current system	Future system
A. Shot Blasting	<p>1) Machine process</p>  <p>Current state uses sixteen front axle batch size stands.</p> <p>2) Unloading process</p>	<p>1) Machine process</p>  <p>Future state recommended using twenty front axle batch size stands instead of sixteen front batch size axle stands thereby increasing production rate.</p> <p>2) Unloading process</p>

International Journal of Innovative Research in Science, Engineering and Technology

(An ISO 3297: 2007 Certified Organization)

Website: www.ijirset.com

Vol. 6, Issue 5, May 2017

	 <p>In current state, unloading is done manually.</p>	 <p>In future state, unloading is to be done by robotic gripper which reduces unloading time from 2.2875min to 1.9415 minutes.</p>
<p>B. Final Grinding</p>	<p>1) Loading system</p> <p>The roller conveyor system lacks coating leading to greater changeover time. This is a major bottleneck operation at manufacturing process line as its machine cycle time is 4.265 min.</p>	<p>1) Loading system</p> <p>Coating of multilayer and composite material improves fracture toughness, maintaining hardness, wear resistance and other mechanical properties of idlers.</p> <p>Ceramic anti-abrasive coating is also used on the surface of idlers. Since ceramic has relatively high hardness, corrosion resistance and heat resistance, it can be widely used as protection coating.</p> <p>This improvement will successfully reduce machine cycle time from 4.265 min to 3.476 min in final grinding.</p>

International Journal of Innovative Research in Science, Engineering and Technology

(An ISO 3297: 2007 Certified Organization)

Website: www.ijirset.com

Vol. 6, Issue 5, May 2017

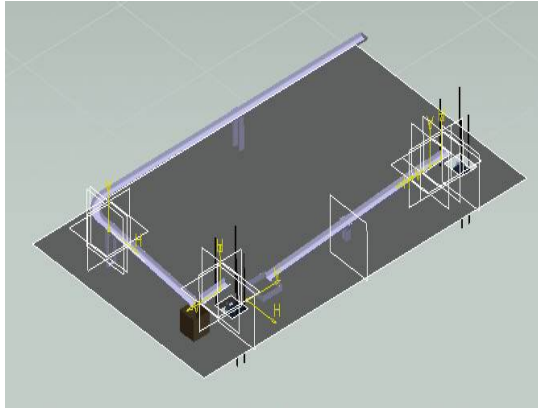
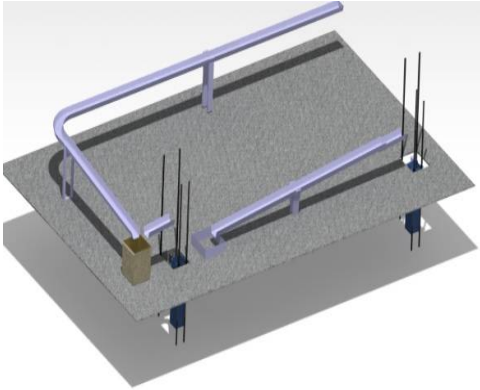
C. Painting	<p>1) Cycle time</p>  <p>In current state, inclination angle of painting system is two degree.</p>	<p>1) Cycle time</p>  <p>In future state, inclination angle is increased from two degree to six degree thus, increasing the flowability of paint. Use of conical curve as base instead of rectangular cross section lessens accumulation of paint in tray.</p>
--------------------	---	--

VII. SIMULATION AND RESULT

Variables	Current	Future	Improvement %
Value added time (min)	14.047	12.467	11.25
Non-value added time (min)	156.09	130.29	16.53
Total-Production-Lead time (min)	170.14	142.76	16.10

The purpose of this research study is to develop and implement Value Stream Mapping (VSM) as a useful tool for improvising Front Axle beam manufacturing process. From above table, it is observed in the total process that the variables- value added time (VA) and Total-Production-Cycle time (TPCT) or Lead time (LT) have shown an improvement of 11.25 % and 16.53 % respectively in future VSM. Similarly there is an improvement in Non-value added time (NVA) by 16.10 % in future VSM. Implementation of kaizen and continuous flow technique effectively in manufacturing process reduces inventory, wastage and improves the quality & safety of work.

International Journal of Innovative Research in Science, Engineering and Technology

(An ISO 3297: 2007 Certified Organization)

Website: www.ijirset.com

Vol. 6, Issue 5, May 2017

VIII. CONCLUSION

The present research study concludes that applying of Value Stream Mapping for Front Axle Beam product in XYZ Manufacturing Company considerably reduces the Non-Value added parameters and Production Lead Time. After drawing the current state map different areas of improvement were identified. The kaizen techniques implemented removed a major bottle neck at final grinding operation, thereby saving process time. Thus Work-in-Process (WIP) is reduced and thereby lead time is reduced. This proves the utility of value stream mapping technique.

REFERENCES

- [1] Nurulzulaiha Sa'udah, Norani Amit & Mohammad Nazri Ali, "Facility Layout for SME Food Industry via Value Stream Mapping and Simulation", International Accounting and Business Conference 2015, IABC 2015.
- [2] Manjunath M., Dr. Shivaprasad H. C., Keerthesh Kumar K. S., Deepa Puthran, "Value Stream Mapping as a Tool for Lean Implementation: A Case Study", IJIRD-Vol 3 Issue 5, 2014.
- [3] Praveen Saraswat, Deepak Kumar, "Application of Value Stream Mapping Tool to Reduce Wastes in Bearing Industry", International Journal of Recent advances in Mechanical Engineering (IJMECH) Vol.3,2014.
- [4] Amir Azizia, Thulasi a/p Manoharanb, "Designing a Future Value Stream Mapping to Reduce Lead Time using SMED-A Case Study", 2nd International Materials, Industrial, and Manufacturing Engineering Conference, MIMEC2015, Vol.2, 2015.
- [5] Friedrich Morlocka, Horst Meiera, "Service Value Stream Mapping in Industrial Product-Service System Performance Management", 7th Industrial Product-Service Systems Conference - PSS, industry transformation for sustainability and business, Vol.3, 2015.