

Modified Buck-Boost Converter with High Step-up and Step-Down Voltage Ratio

Arsha R ¹, Rosemin Parackal ²

M.Tech Student, Department of Electrical and Electronics Engineering, FISAT, Angamaly, Kerala, India¹

Assistant Professor, Department of Electrical and Electronics Engineering, Federal Institute of Science and Technology, Angamaly, Kerala, India²

ABSTRACT: High step up converters and step down converters are required in many industrial applications and in energy harvesting systems. Buck-boost converters have simple structure and high efficiency but their operation is restricted due to limited voltage gain. By inserting additional switching circuit in the traditional buck-boost converter the gain of the converter is increased and its output polarity is made positive. Now the converter can operate in a wide range of output voltage. Using this converter high step-up and step-down voltage conversion can be made possible without using a transformer. The operating principles of the transformer-less buck-boost converter operating in CCM are presented in detail. The feasibility of the converter is verified through simulation.

KEYWORDS: Transformer-less buck-boost converter, positive output voltage, continuous conduction mode, high voltage gain, Mat-lab.

I. INTRODUCTION

Because of faster degradation of non-renewable energy, renewable or clean energy sources such as solar cells and fuel cells are increasingly valued worldwide. However, due to the inherent low voltage characteristic of these sources, a high voltage ratio converter is essential as a pre-stage of the corresponding power conditioner.

Conventional Buck converter and boost converter have the simple structure and high efficiency. In order to provide a high voltage-conversion ratio, the basic converters would have to operate with an extreme value of the duty cycle, smaller than 0.1 in voltage-step-down converters, higher than 0.9 in voltage-step-up converter. But due to their reduced overall efficiency as the duty ratio approaches unity, cannot fulfil the application need. Besides, the extreme duty ratio not only induces very large voltage spikes and increases conduction losses but also induces severe diode reverse-recovery problem. Many topologies have been proposed to provide a high voltage gain without high duty ratio.

Isolated converters can achieve high step-up conversion easily by using transformer with large turn ratio. Unfortunately, large turn ratio introduces several problems, such as the larger leakage inductance and the parasitic capacitance formed by the secondary winding of the transformer, which causes voltage and current spikes and increases losses and noise that can significantly degrade the systems performance and damage circuit components [3]. In order to reduce system cost and to improve system efficiency, a non-isolated converter is, in fact more suitable solution.

Several advanced enhancement techniques, which are based on the applications of classical non-isolated dc-dc topologies, such as switched-capacitor and coupled-inductor, have been greatly used. The switched capacitor-based converters can achieve large voltage conversion ratio. Unfortunately, this technique makes the switch suffer high transient current and large conduction losses [4]. In coupled inductor-based converters the turn ratio of the coupled inductor can be employed as another control freedom to extend the voltage gain [5]. However, the input current ripple is relatively large, which may shorten the usage life of the input electrolytic capacitor. In this study, by inserting an additional switched network into the traditional buck-boost converter, a transformer-less buck-boost converter is proposed. The main merit of this transformer-less buck-boost converter is that its voltage gain is square of the

traditional buck-boost converter so that it can operate in a wide range of output voltage, that is, the buck-boost converter can now achieve high or low voltage gain without extreme duty cycle. Moreover, the output voltage of this transformer-less buck-boost converter has its output polarity is positive. Paper is organized as follows. Section II describes the basic operating principle. Section III presents mat-lab simulation results for the converter. Finally, Section IV presents conclusion.

II. BASIC OPERATING PRINCIPLES

The converter operates in CCM (Continuous Current Mode). There are 2 states for the converter based on the on and off condition of the switches.

State 1 ($NT < t < (N+D)T$): During this interval switches S_1 and S_2 are turned on. Diodes D_1 and D_0 are reverse biased. Inductor L_1 is magnetized from the input voltage V_{in} while inductor L_2 is magnetized from the input voltage V_{in} and the

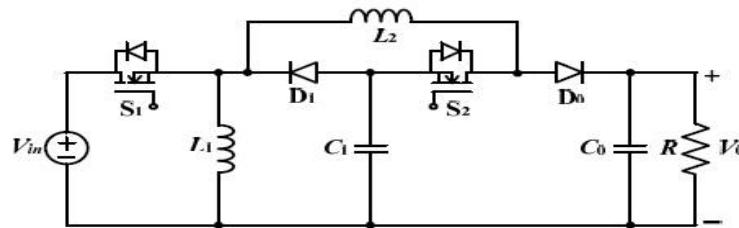

Fig.1: Transformer-less Buck Boost Converter

charge pump capacitor C_1 . Also, the output energy is supplied from the output capacitor C_0 . Thus, the corresponding equations can be given as

$$V_{L1} = V_{in} \tag{1}$$

$$V_{L2} = V_{in} + V_{C1} \tag{2}$$

State 2 ($(N+D)T < t < (N+1)T$): During this time interval, the switches S_1 and S_2 are turned off. Diodes D_1 and D_0 are forward biased. From Fig. 3, it is seen that the energy stored in the inductor L_1 is released to the charge pump capacitor C_1 via the diode D_1 . At the same time, the energy stored in the inductor L_2 is released to the charge pump capacitor C_1 , the output capacitor C_0 and the resistive load R via the diodes D_0 and D_1 . The corresponding state equations are described as follows

$$V_{L1} = -V_{C1} \tag{3}$$

$$V_{L2} = -(V_{C1} + V_0) \tag{4}$$

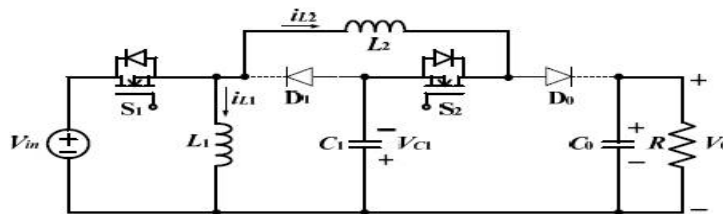

Fig.2: Equivalent circuit in State1

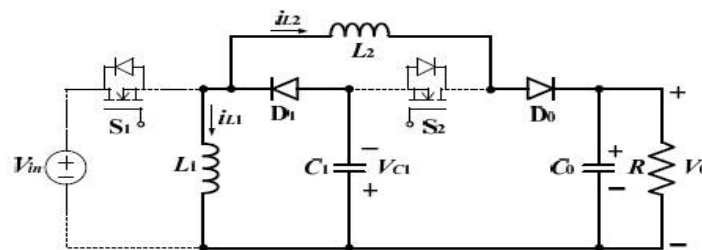

Fig.3: Equivalent circuit in State2

Applying the voltage-second balance principle on the inductor L_1 , then the voltage across the charge pump capacitor C_1 is readily obtained from (1) and (3) as

$$V_{C1} = \frac{D}{1-D} V_{in} \tag{5}$$

Here, D is the duty cycle, which represents the proportion of the power switches turn-on time to the whole switching cycle. Similarly, by using the voltage-second balance principle on the inductor L_2 , the voltage gain of the proposed buck-boost converter can be obtained from (2), (4), and (5) as

$$M = \frac{V_o}{V_{in}} = \frac{D^2}{(1-D)^2} \tag{6}$$

The transformer-less buck-boost converter can step-up the input voltage when the duty cycle is bigger than 0.5, and step-down the input voltage when the duty cycle is smaller than 0.5.

Capacitor voltage V_{c1} is less than the input voltage in step-down mode, and less than the output voltage in step-up mode. Consequently, the voltage stress on the charge pump capacitor C_1 is small so that we can choose the small-sized capacitor which have small parasitic resistor to reduce the power loss. The voltage stress of the two power switches (S_1 and S_2) and two diodes (D_1 and D_0) can also be derived:

$$V_{S1} = \frac{1-D}{D} V_o \tag{7}$$

$$V_{S2} = \frac{1}{D} V_o \tag{8}$$

$$V_{D1} = \frac{1-D}{D^2} V_o \tag{9}$$

$$V_{D2} = \frac{1}{D} V_o \tag{10}$$

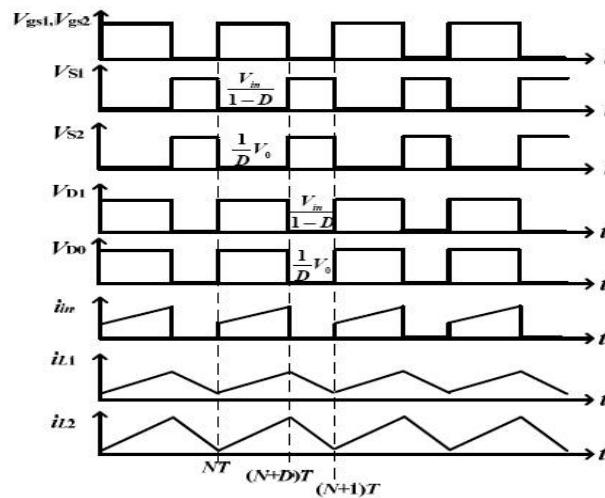

Fig.4:Typical Wave form Current ripple of inductor L_1 and L_2 is

$$\Delta i_{L1} = \frac{DV_{in}}{L_1 f_s} \tag{11}$$

$$\Delta i_{L2} = \frac{DV_{in}}{L_2 f_s (1-D)} \tag{12}$$

where D-duty ratio, V_{in} -input voltage, f_s -switching frequency. L_1 and L_2 can be found from equation 7 and 8

The ripples of the voltage across the capacitors C_1 and C_0 , that is, ΔV_{C1} and ΔV_{C0} are

$$\Delta V_{C1} = \frac{DV_o}{(1-D)RC_1 f_s} \tag{13}$$

$$\Delta V_{C0} = \frac{DV_o}{RC_0 f_s} \tag{14}$$

where V_o -output voltage, R-resistive load, D-duty ratio, f_s -switching frequency. Capacitance C_0 and C_1 can be calculated based on equation 9 and 10.

III. SIMULATION RESULT

Simulation for the transformer-less buck-boost converter is done in mat-lab. Input voltage $V_{in}=18V$, switching frequency $f_s=20KHz$, inductor values $L_1=1mH$, $L_2=3mH$, capacitor values $C_1=10\mu H$, $C_0=20\mu H$, resistance $R=30-150\Omega$. Closed loop system can be obtained using proportional integral controller (PI). Both switches are given switching pulses synchronously.

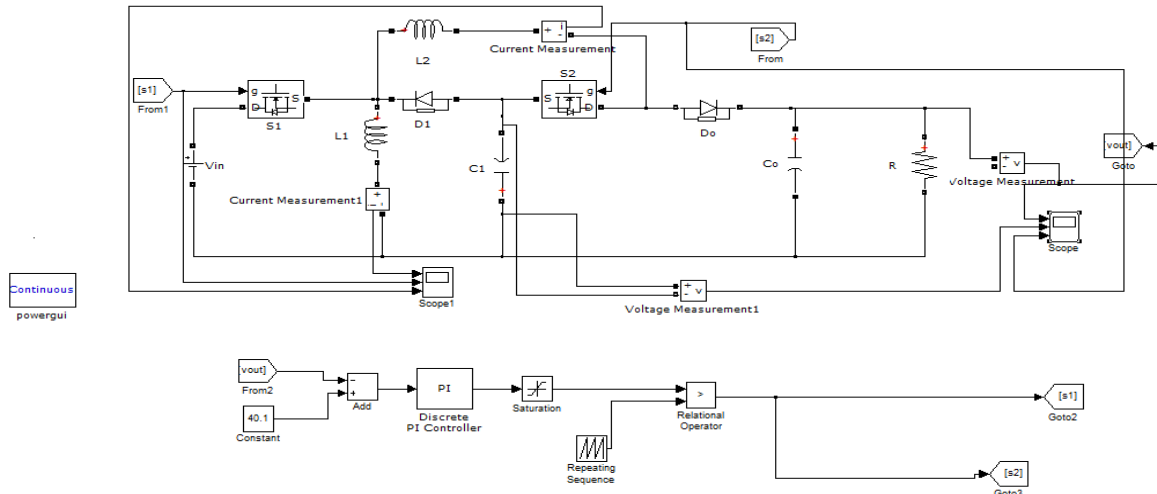

Fig.5: Simulink model for the closed loop system

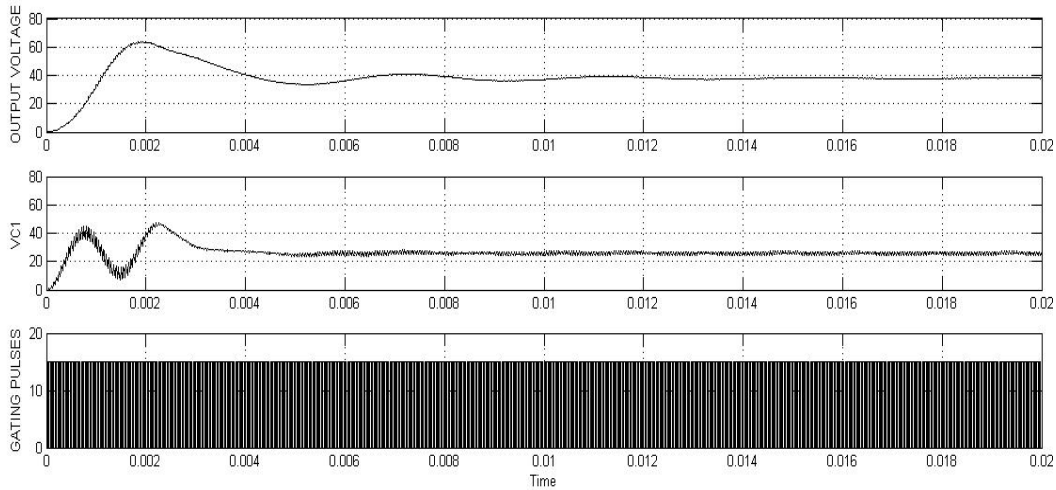

Fig.6 :Transformer-less buck-boost converter in boost mode V_0 , V_{C1} , gate pulse

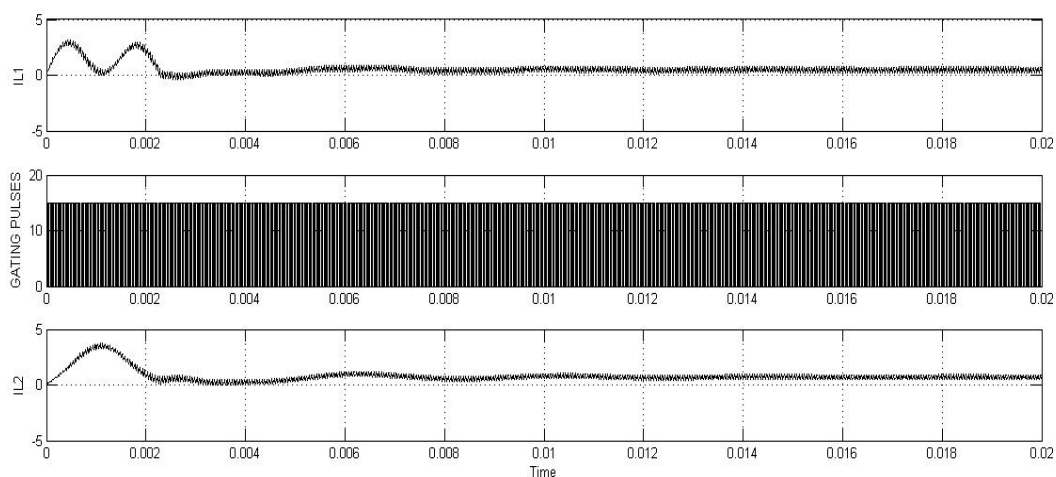

Fig.7:Transformer-less buck-boost converter in boost mode i_{L1} , gate pulse, i_{L2}

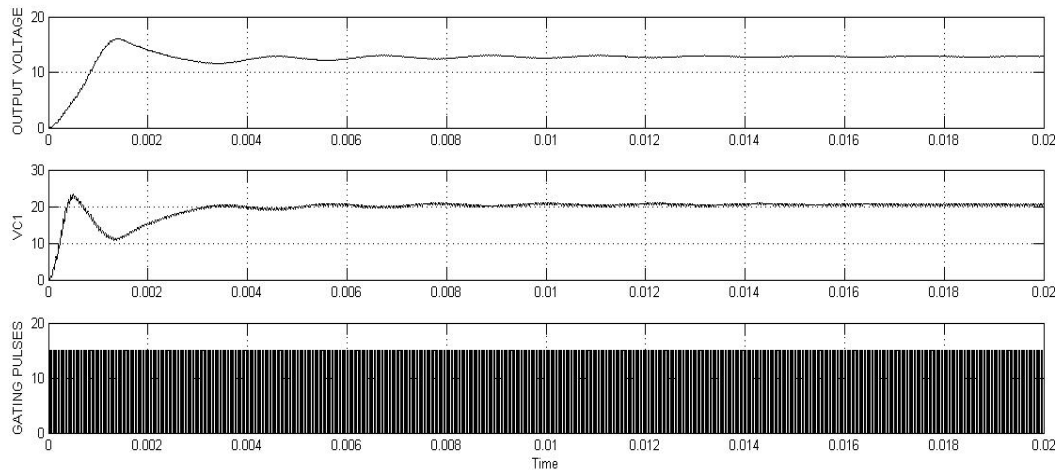

Fig.8:Transformer-less buck-boost converter in buck mode V_0, V_{C1} , gate pulse

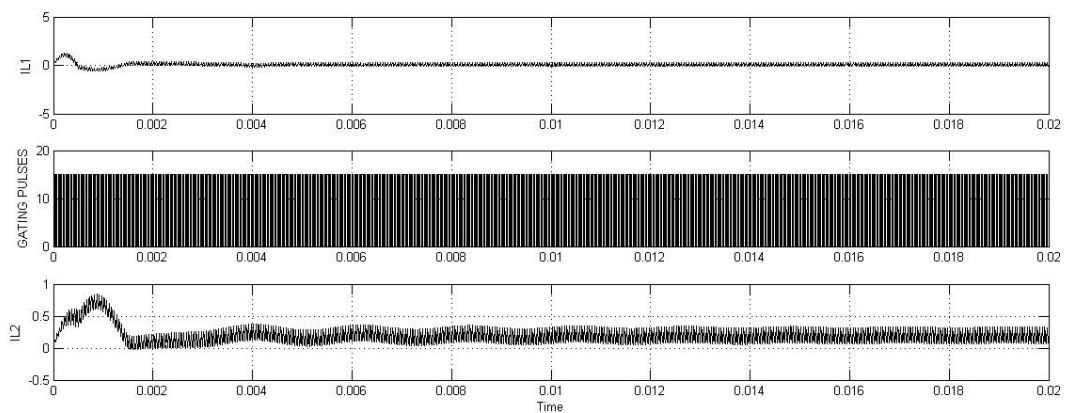

Fig.9:Transformer-less buck-boost converter in buck mode i_{L1} , gate pulse, i_{L2}

IV. CONCLUSION

The transformer-less buck-boost converter realizes the optimization between the topology construction and the voltage gain to overcome the drawbacks of the traditional buck-boost converter is studied in this paper. The operating principles and Mat-lab simulations are presented in this paper. The transformer-less buck-boost converter possesses the merits such as high step-up/step-down voltage gain, positive output voltage, simple construction and simple control strategy. Hence, the proposed buck-boost converter is suitable for the industrial applications requiring high step-up or step-down voltage gain.

REFERENCES

- [1] Shan Miao, Faqiang Wang, and Xikui Ma, "A new transformerless buck-boost converter with positive output voltage," *IEEE Trans. Ind. Electron.*, Vol. 63, no. 5, pp. 2965 - 2975, May 2016.
- [2] C. T. Pan, C. F. Chuang, and C. C. Chu, "A novel transformerless adaptable voltage quadrupler DC converter with low switch voltage stress," *IEEE Trans. Power Electron.*, vol. 29, no. 9, pp. 4787-4796, Sep. 2014.
- [3] L. W. Zhou, B. X. Zhu, Q. M. Luo, and S. Chen, "Interleaved non-isolated high step-up DC/DC converter based on the diode-capacitor multiplier," *IET Power Electron.*, vol. 7, no. 2, pp. 390-397, Feb. 2014.
- [4] M. Prudente, L. L. Pfitscher, G. Emmendoerfer, E. F. Romanelli, and R. Gules, "Voltage multiplier cells applied to non-isolated DC-DC converters," *IEEE Trans. Power Electron.*, vol. 23, no. 2, pp. 871-887, Mar. 2008.
- [5] L. S. Yang, T. J. Liang, H. C. Lee, and J. F. Chen, "Novel high step-up DC-DC converter with coupled-inductor and voltage-doubler circuits," *IEEE Trans. Ind. Electron.*, vol. 58, no. 9, pp. 4196-4206, Sep. 2011