

Experimental Verification of Thermo Acoustic Refrigeration

Arun K G¹, Aju Sivan², Arun Chand³

Assistant Professors, Department of Mechanical Engineering, ASIET, Kalady, Kerala, India¹

Assistant Professors, Department of Mechanical Engineering, ASIET, Kalady, Kerala, India²

Lecturer, Department of Automobile Engineering, Govt. Poly Technic College, Kalamassery, India²

ABSTRACT: Thermo acoustic refrigeration is an innovative alternative for cooling that is both clean and inexpensive. Through the construction of a functional model, I would like to demonstrate the effectiveness of thermo acoustics for modern cooling. Refrigeration relies on two major thermodynamic principles. First, a fluid's temperature rises when compressed and falls when expanded. Second, when two substances are placed in direct contact, heat will flow from the hotter substance to the cooler one. While conventional refrigerators use pumps to transfer heat on a macroscopic scale, thermo acoustic refrigerators rely on sound to generate waves of pressure that alternately compress and relax the gas particles within the tube. By preparing a prototype of the system and conducting experiments with the model I would like to check whether the thermo acoustic refrigerators could be viable replacements for conventional refrigerators. Sound waves are propagated through the air by the means of molecular collisions. These collisions create disturbances in air, resulting in constructive and destructive interference. Constructive interference creates a front of high pressure, compressing molecules, while destructive interference lowers pressure and in turn allows molecules in the air to expand. This property of sound waves is the foundation of the science behind thermo acoustic refrigerator.

KEYWORDS: Sound waves, Thermo acoustic refrigeration

I. INTRODUCTION

Refrigeration may be defined as the process of achieving and maintaining a temperature below that of the surroundings, the aim being to cool some product or space to the required temperature. One of the most important applications of refrigeration has been the preservation of perishable food products by storing them at low temperatures. Refrigeration systems are also used extensively for providing thermal comfort to human beings by means of air conditioning. Air Conditioning refers to the treatment of air so as to simultaneously control its temperature, moisture content, cleanliness, odour and circulation, as required by occupants, a process, or products in the space.

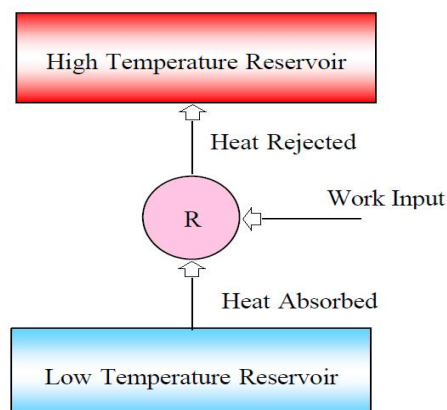

Fig1.Schematic representation of refrigeration system

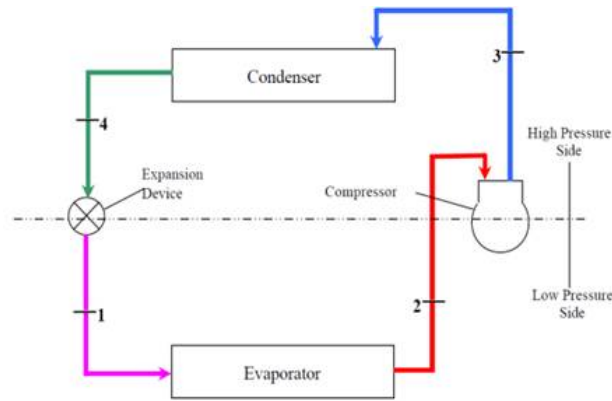

Fig.2 Schematic representation of the vapour compression refrigeration cycle

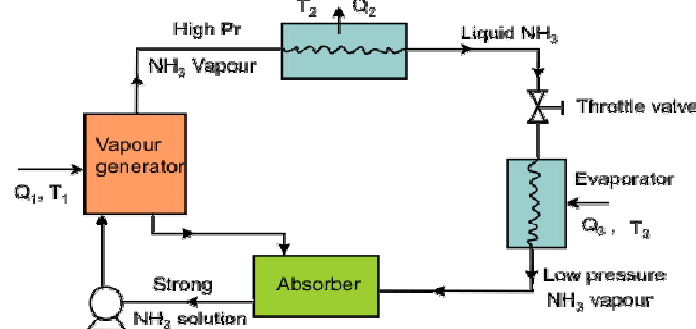

Fig 3 A simple schematic of a vapour absorption refrigeration system

Alternative Types of Refrigeration

- a. MAGNETIC REFRIGERATION
- b. THERMOELECTRIC REFRIGERATION

Effects of Cfc's On Environment

CFCs, when released from the surface of the Earth, rise slowly into the stratosphere. Once there, they are bombarded by the incoming UV light from the Sun, releasing the chlorine atoms from the parent compound, which can then react with the ozone molecules. Eventually the chlorine atom is removed from the atmosphere by other reactions.

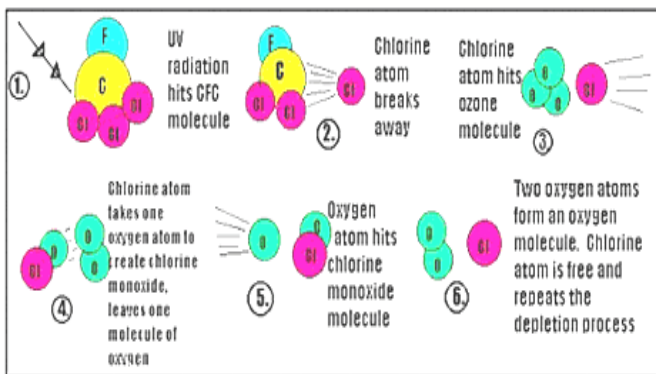

Fig.4 The destruction of stratospheric ozone

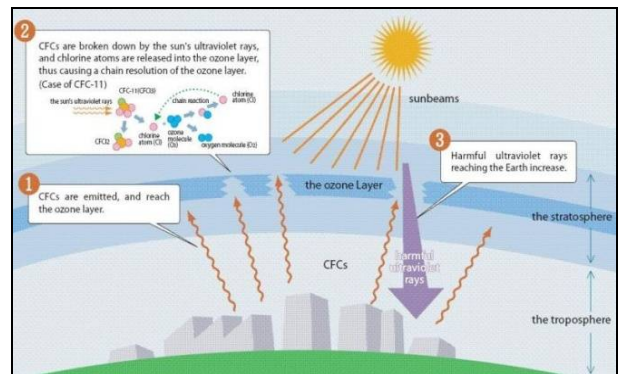

Fig.5 Effects of CFC'S on Environment

II. THERMOACOUSTIC REFRIGERATION

One ordinarily thinks of a sound wave as consisting only of coupled pressure and position oscillations. In fact, temperature oscillations accompany the pressure oscillations and when there are spatial gradients in the temperature oscillations, oscillating heat flow occurs. The combination of these oscillations produces a rich variety of "thermoacoustic" effects. In everyday life, the thermal effects of sound are too small to be easily noticed; for example, the amplitude of the temperature oscillation in conversational levels of sound is only about 0.0001°C. However, in an extremely intense sound wave in a pressurized gas, these thermo acoustic effects can be harnessed to create powerful heat engines and refrigerators.

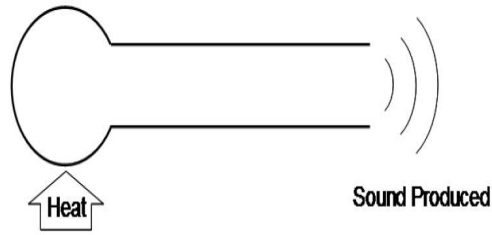

Fig.6 Soundhauss tube

Basic Principle of Thermoacoustics

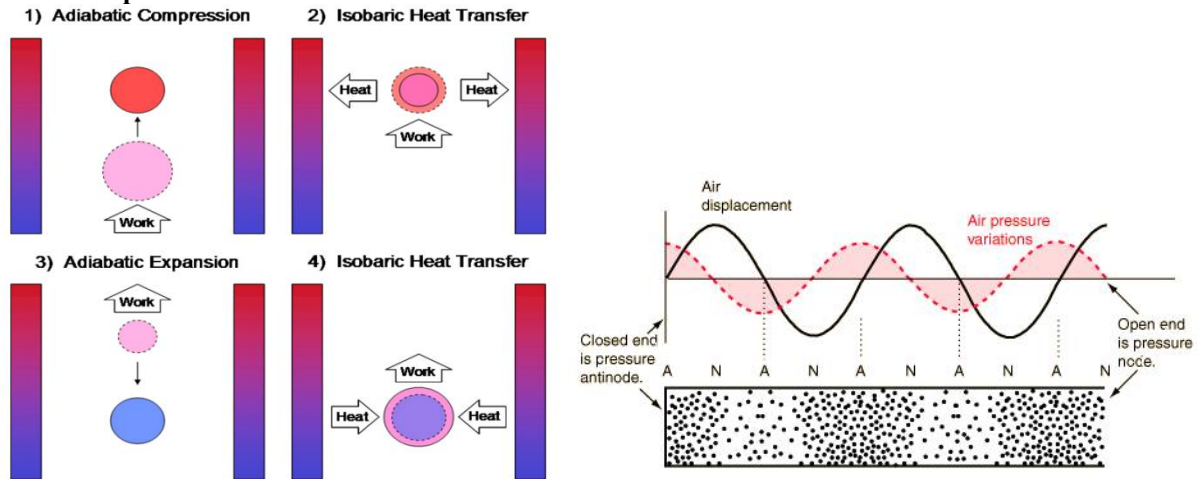

Fig. 7 Heat work interaction of gas molecules

Thermo acoustics refers to the production of acoustic waves by way of heat transfer (or the converse, that is, sonically induced heat gradients). This is usually done by way of a resonance tube, either with two open ends, or one end open and one end closed. In the case of two open ends, pressure waves are referred to as Rijke oscillations, and have been studied thoroughly for two centuries. Of more interest to us are oscillations in a tube with one closed end, known as Soundhauss oscillations. As the temperature increases, heat is converted to kinetic energy in the gas molecules at the closed end of the tube. The gas molecules accelerate towards the cooler end of the tube, thereby creating an area of relative low pressure in the heated end. As these molecules cool off, other gas molecules accelerate towards the hot end to fill in the area of low pressure. These molecules are then heated, and the process begins again. This completes one cycle of a thermal oscillation, and is analogous to the Stirling Cycle.

III. CONSTRUCTION

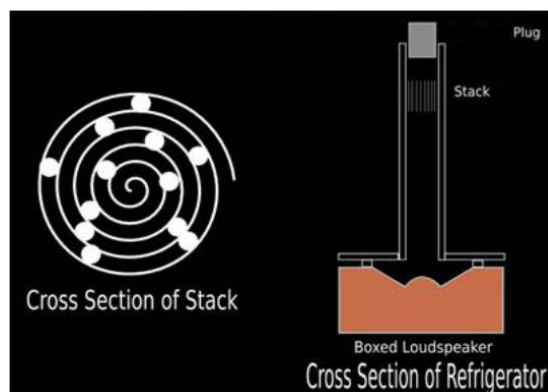

Fig.8 Basic construction of a thermo acoustic refrigerator

Materials Required

The above is a schematic diagram of our experimental set up. It basically consists of:

1. Acrylic tube(1 inch,1.25 inch, 1.5 inch)
2. Acrylic Sheet to cover the speaker
3. Sealing and Insulating Tapes
4. Rubber Sheet

5. Box for covering the speaker
6. Speaker(40W, 6 inch)
7. Amplifier(5000 PMPS)
8. Laptop with software to produce constant frequency sound
9. Cap or Plug(copper)
10. Thermometers (2 numbers)
11. Stack

Stack

Stack is the most important part of the project experiment. It is generally a devise that is used to absorb the heat and prevent the heat transfer from the high temperature side to the low temperature side. The stack is composed of many narrow passages separated by thin plates.

Tooth Pick And Paper

Here we used a combination of tooth pick and paper. The tooth picks were cut and pasted on the paper at different lengths

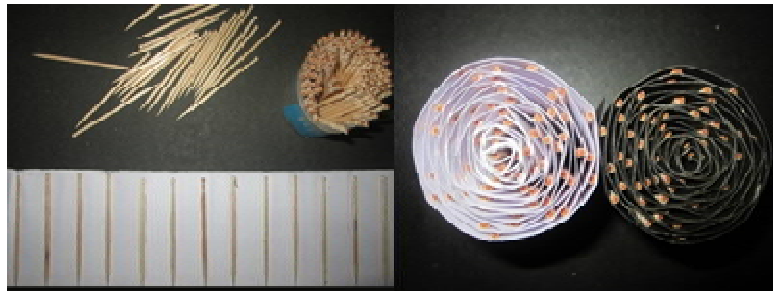

Fig.9 Stack arrangements with Paper and Toothpick

Gut With Paper

Here we used a combination of paper and gut used to tie tennis bats. Here the guts were cut and pasted at different lengths on the paper.



Fig.10 Stack arrangements with Paper and Guts

Corrugated Paper

Here we used a corrugated paper and rolled it so as to get fixed in the acrylic tube.



Fig.11 Stack arrangements with Corrugated Paper

Photo Film With Fishing Line

Finally we used a combination of photo film and fishing line. Here the fishing lines were cut and pasted on the photo film at different lengths.



Fig.12 Stack arrangements with Photographic Film and Fishing Line

IV. FINAL ASSEMBLY

The resonance tube, which has the stack and two thermometers, was inserted into the wooden box containing the speaker. The two wires were connected to the amplifier. A connection from the amplifier to a laptop was made. The necessary sinusoidal wave was generated using a sound generator, which is a laptop and the useful software. The software for this purpose is downloaded from the internet.

We set up an experimental set up as in the apparatus. We then connected the laptop, which was equipped with the software that could produce constant frequency sound, to the amplifier and connected this to the speaker. After, we inserted the machined copper stoppers (roughly 1.25 inch to 1.5 inch in diameter) which were needed to create the closed tube necessary for standing waves.

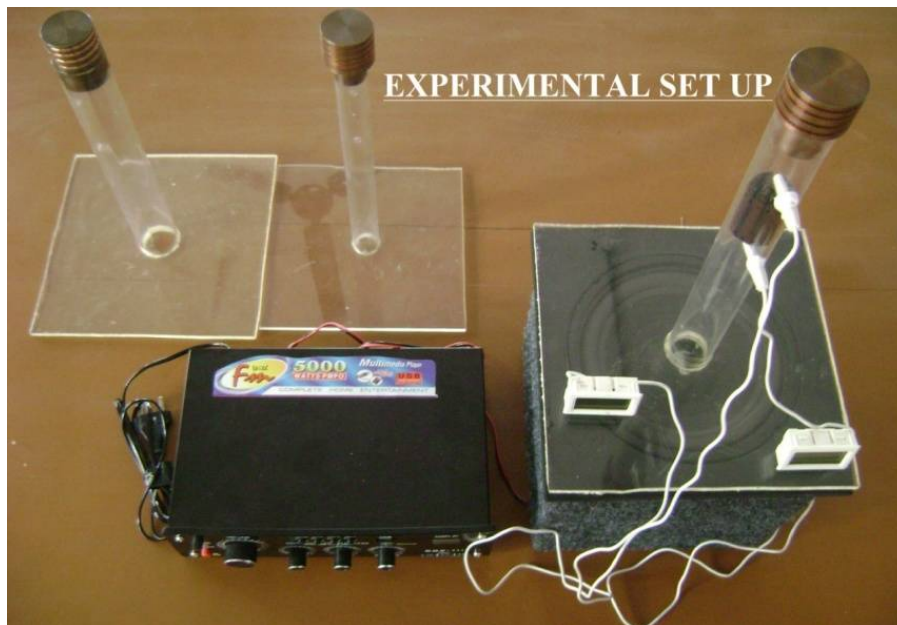

Fig.13 Experimental Setup

Next, we determined the proper frequency needed to achieve a standing wave. This is supposed to be at the first harmonic, or, when the wavelength is 2 times the length of the tube. We measured the length of the tube to the bottom of the aluminum cap and multiplied by 2 and divided the speed of sound at room temperatures, or roughly 349 m/s, by the length of tube. We determined the frequency to be around 370 Hz.

Once we found the optimal resonant frequency for our refrigerator, we used the software in the laptop to produce the specific frequency. Basically, the generator vibrates the speaker cone at that frequency, which subsequently vibrates the air and causes the heat transfer to occur. We listened to verify for the sound of the harmonic, and when verified, we increased the intensity of the frequency and then recorded the temperatures of the two thermocouples. Now this experimentation was done for various frequency ranging from 370Hz to 400Hz.

V. TESTS & RESULTS

Experiment No:1

Testing Of Set Up With Stack Made Of Paper And Toothpick

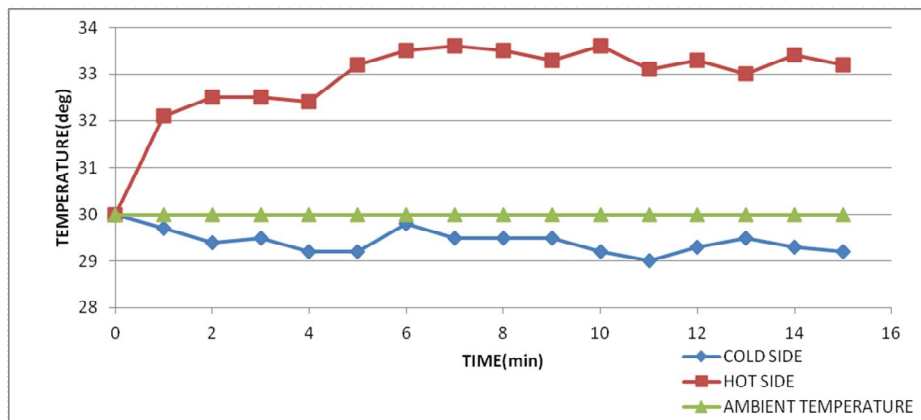

Fig.14 Time temperature graph with paper and toothpick

Acrylic Tube Diameter = 2.54 cm

Though a temperature gradient is obtained much appreciable decrease from room temperature was not observed. The maximum temperature gradient observed are 33.6°C on cold side, 29.2°C on hot side, with a 10 min elapsed time.

Experiment No: 2

Testing Of Set Up With Stack Made Of Paper And Guts

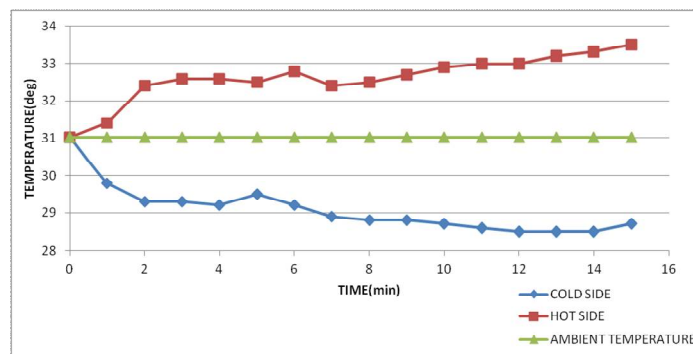

Fig.15 Time temperature graph with paper and guts

Acrylic Tube Diameter = 2.54 cm

A good temperature gradient is obtained and a decrease of 2.5°C was observed from room temperature within 14minutes. The maximum temperature gradient observed 28.7°C on cold side 33.5°C on hot side

Experiment No: 3

Testing Of Set Up With Stack Made Of Corrugated Paper

Acrylic Tube Diameter = 2.54 cm

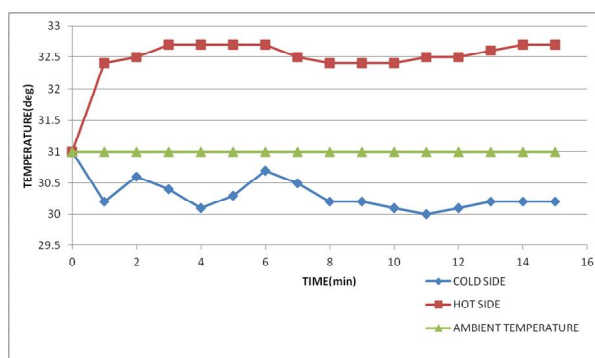

Fig.16 Time temperature graph with corrugated paper

Experiment No: 4
Testing Of Set Up With Stack Stack Made Of Photographic Film And Fishing Line
 Acrylic Tube Diameter = 3.81cm

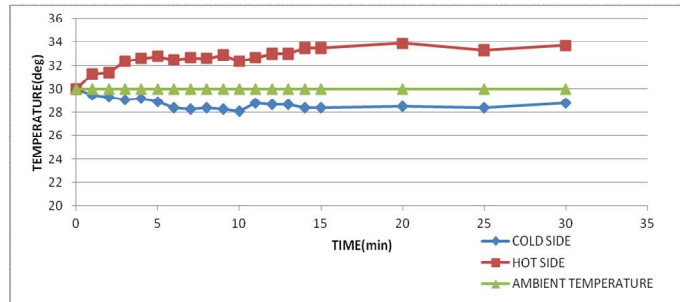

Fig.17 Time temperature graph with photographic film and fishing line

Experiment No: 5
Testing Of Set Up With Stack Stack Made Of Photographic Film And Fishing Line
 Acrylic Tube Diameter = 3.175cm

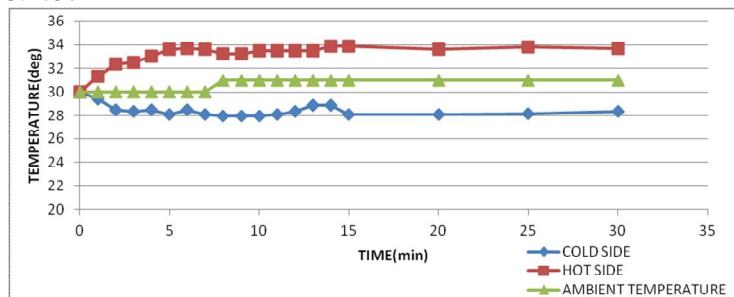

Fig.18 Time temperature graph with photographic film and fishing line

VI. CONCLUSION

Specific Benefits Of Thermoacoustics For Air Conditioning Applications

Preliminary research has established thermoacoustics as suitable technology for most heating & cooling applications. Feasibility studies show thermoacoustics is better suited for the operating temperatures of A/C applications versus low temperature application (cryogenic level temperatures) that have been successfully commercialized. Thermoacoustic based A/C equipment should have substantially lower manufacturing costs compared to conventional compressors. The mechanical simplicity of these systems versus conventional compressors, which require gears, pistons, valves and timing chains along with no lubrication requirements or scheduled maintenance, should extend the service life - potentially 200 to 300 percent longer than present systems. Photo to the right is a thermoacoustic unit build by students at a University.

Table 1. A/C and Refrigeration Technologies Compared

	Technology Under Development	Current Technology	Recently Introduced Technology	Recently Introduced Technology
Relative Performance Measures	Thermoacoustics	Vapor Compression	Hydrocarbons	Carbon Dioxide
Ozone Depletion Potential	None	CFCs, HCFCs	None	None
Greenhouse Effects	None	Very High	Low	Low
Energy Efficiency - power grid	High	Moderate	Moderate High	Moderate
Energy Efficiency - solar power	100%	Not Practical	Not Practical	Not Practical

Operating Mode	Proportional	On/Off	On/Off	On/Off
Initial Equipment Costs	Low	High	High	Very High
Maintenance Costs	None	Moderate	Moderate	Moderately High
Operating Life Cycle	Very Long	Moderate	Moderate	Moderate

Thermo acoustic systems can maintain a constant temperature by matching input power to load conditions and produce higher efficiency than systems using an on/off cycle to control temperature as most vapor compression systems do today. Other technologies may be pursued, as compliance with the Montreal Protocol progressively reduces the use of banned gases, however many of these technologies have substantial drawbacks - including flammability, corrosiveness and extremely high operating pressures.

REFERENCES

- [1] Journal on thermo acoustic refrigeration by Steven L. Garrett, Thomas J. Hofler, and David K. Perkins
- [2] Journal on thermo acoustic refrigeration by Dev Doshi, Thomas Fenvick, Amanda Gaetano.C. Herman, Z. Travnicek. Cool sound: the future of refrigeration?
- [3] Thermodynamic and heat transfer issues in thermoacoustic refrigeration. Heat and Mass Transfer. April 2006
- [4] Tabletop thermoacoustic refrigerator for demonstrations by Daniel A. Russell and Pontus Weibulla *Science and mathematics department, Kettering University!Flint,Michigan48504*