

Zonewise Fault Detection and Energy Management Strategies for KSEB

Amritha Shaji¹, Arya R², Chaithanya T S³, Roshia Karim⁴, Sreerya S⁵, Edwina G Rodrigues⁶,

Kannan S A⁷, Rekha T⁸

B. Tech Scholars, Department of Electrical & Electronics Engineering, College of Engineering, Perumon, Kollam, Kerala, India¹⁻⁵

Assistant Professors, Department of Electrical & Electronics Engineering, College of Engineering, Perumon, Kollam, Kerala, India⁶⁻⁸

ABSTRACT: In this paper, we introduce a taxonomy for classification of faults such as under voltage, overvoltage, over current and frequency variations and isolate the faulty zone at distribution side in a power system. The power demand is increasing and also the management of electric power distribution system is becoming more complex. The effective detection and correction of the faults in distribution side still remains an enigma to the power company. Such situations will lead to power disruption of a wide area. The existing system offers unlimited access to the usage of energy which in turn leads to massive power wastage. The proposed system is useful for facilitating alternative supply to an emergency load from nearby healthy zone. The proposed system also controls demand by shedding loads whenever the load exceeds the peak limit and is also provided with an innovative scheme for theft detection and monitoring of electrical power theft in the electrical distribution system.

KEYWORDS: CT-Current Transformer ;PT-Potential Transformer; ZCD- Zero crossing detector

I. INTRODUCTION

The consumption of electricity is increasing at a much faster rate. Faults in distribution system side are more frequent than those in transmission side. It is found that 80% of consumer service interruption are due to failures in distribution system. Protection of power system requires an understanding of system faults, their detection and safe isolation of the faulted device. By taking an inventory of all the essential electric loads and doing a basic electrical load evaluation, an idea regarding how much power our system needs to produce has been obtained.

While technology is on the raising slopes, we should also note the increasing immoral activities. With a technical view, Power Theft is a non ignorable crime and at the same time it directly affected the economy of a nation. Electricity theft is social evil, so it has to be completely eliminated. Therefore proper monitoring of energy thefts is required. Power consumption and losses have to be closely monitored so that the generated power is utilized in a most efficient manner. The system prevents the illegal usage of electricity. At this point of technological development the problem of illegal usage of electricity can be solved electronically without any human control. The implementation of this system will save large amount of electricity, and there by electricity will be available for more number of consumer than earlier, in highly populated country such as India.

In distribution line multiple fault detection and indication to electricity board deals with the problem of automatically detecting the fault and intimation to electricity board. The proposed system also focuses on theft detection and energy management. This project deals with the design and fabrication of power supply, microcontroller and ARMS. This proposal greatly reduces the man power, saves time, operates efficiently, manage energy usage and avoids unwanted power supply interruption and energy theft.

II. BLOCK DIAGRAM AND DESCRIPTION

The distribution system is divided into several small zones based on their power capacity and each zone houses several consumers. The line voltage and the current levels of each zone are fed to the microcontroller by using CT/PT. ZCD with counter measures frequency and is used to compare with the supply frequency.

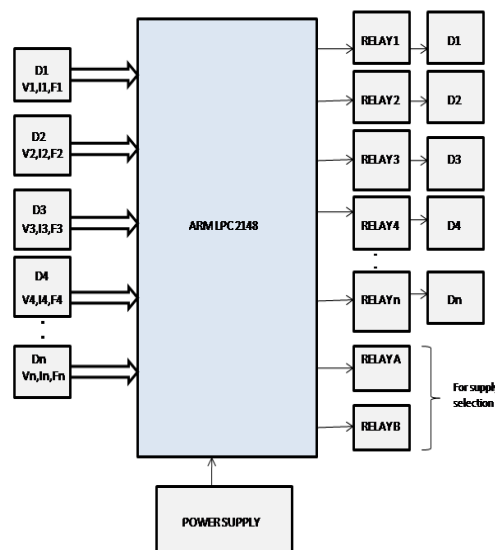

Fig 1. Proposed Block Diagram

The microcontroller compares the input values with that of the programmed parameters and thus find out the faulty conditions. The faulty zones are thus identified. The supply is cut out in the faulty zone using relay and current sensors act on them after a delay time. Then the relay is again connected and check whether the fault is cleared or not. If it is not cleared, then the relay is cut off. A message containing the information of the zone is send to the line man. After clearing the fault, the lineman can automatically connect the relay back by messaging. If there is any emergency load in the faulty zone, alternate supply can be given from healthy zone using alternative paths. The proposed model also developed an android application for the lineman which provides the details of the instant values of voltage, current and frequency of the zone and thereby helps in proper monitoring of distribution lines. It also facilitates automatic isolation of distribution lines through messaging.

Energy Management

A load limit is fixed based on load pattern. Microcontroller compares the zone consumption with this load limit. If the energy intake in a particular zone exceeds this limit, at first a warning is given and after a delay time the load consumption is again checked. If the consumption is not reduced, then for that zone load shedding is provided.

Theft detection

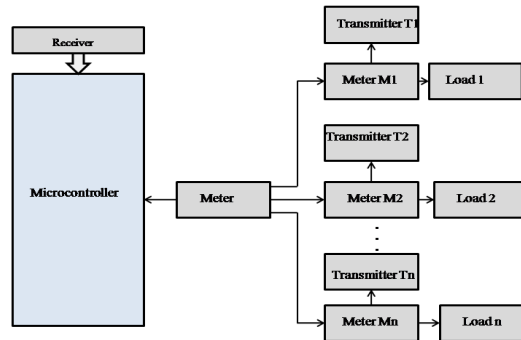

Fig 2. Theft Detection System

A zone energymeter is used to measure energy taken by a particular zone. The meter readings from consumer side is given to the microcontroller and sum of these readings are taken. This value is compared with the zone energymeter reading. Suppose if there is any unauthorized tapping taken in a zone, message is sent to the power utility centre. Thus Energy Theft in a zone is found out.

III .FLOWCHART & ALGORITHM

Algorithm for Theft detection

Step 1:Read Zone and load meter readings

Step 2:Calculate the total load used

Step 3:Check whether zone meter reading equals total load used.

Step 4:If No, display " Theft detected " and send a signal to power utility , else goto step 1.

Flowchart for Theft detection

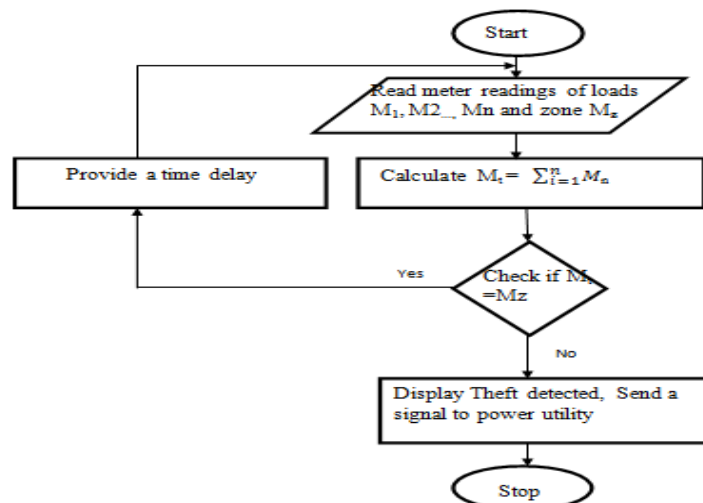

Algorithm for Fault detection

- Step 1: Set the base values of voltage, current and frequency
- Step 2: Read zone voltage, current & frequency
- Step 3: Check if zone current, voltage and frequency within the limits
- Step 4: If No, fault exists and faulty zone relay cut off
- Step 5: Relay of faulty zone turned on after a time delay
- Step 6: Check if faults exists.
- Step 7: If No, goto step 2
- Step 7: Else, cut off the relay of faulty zone and message sent to lineman
- Step 8: Fault cleared and relay turned on by messaging

Flowchart for Fault detection

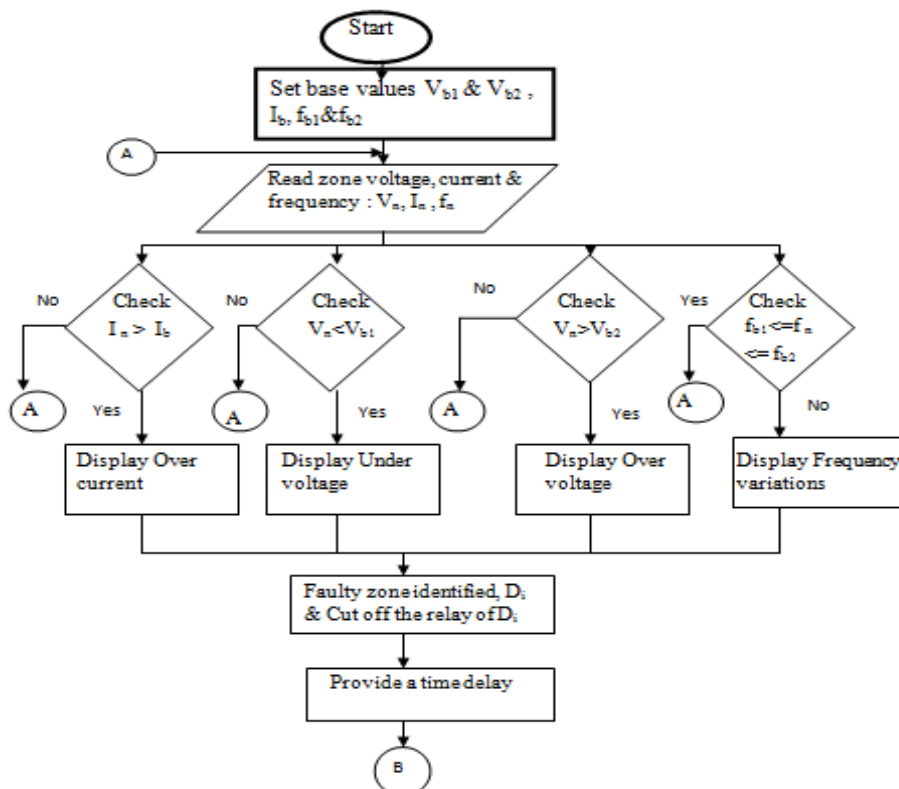

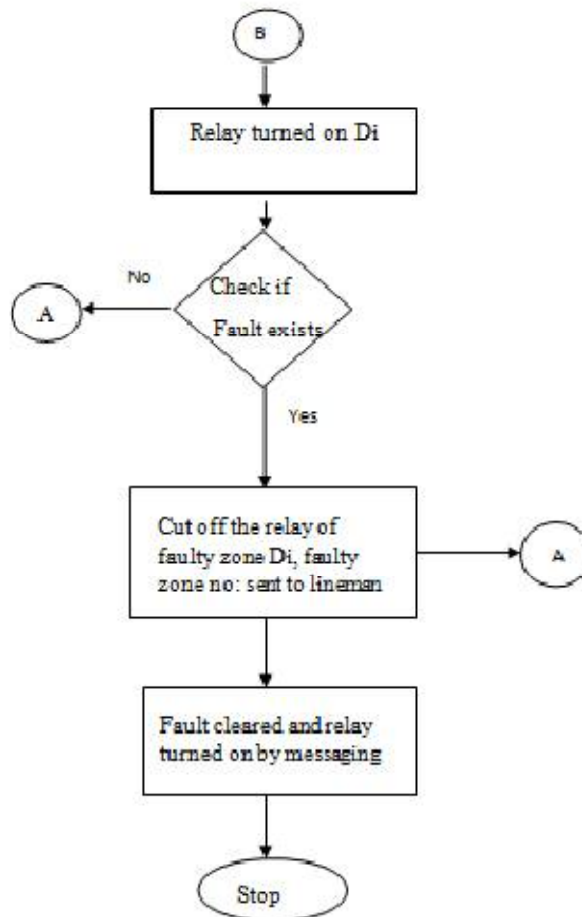

Algorithm for Energy management

Step 1: Set the load limit PL

Step 2: Read zone load Pz

Step 3: Check if $P_z > P_L$

Step 4: If no, goto step 2 Step 5: Else, Display "Overload" and provide a warning alarm

Step 6: Check if $P_z > P_L$ after a time delay

Step 4: If no, goto step 2

Step 5: Else, Relay cut off

Flowchart for Energy management

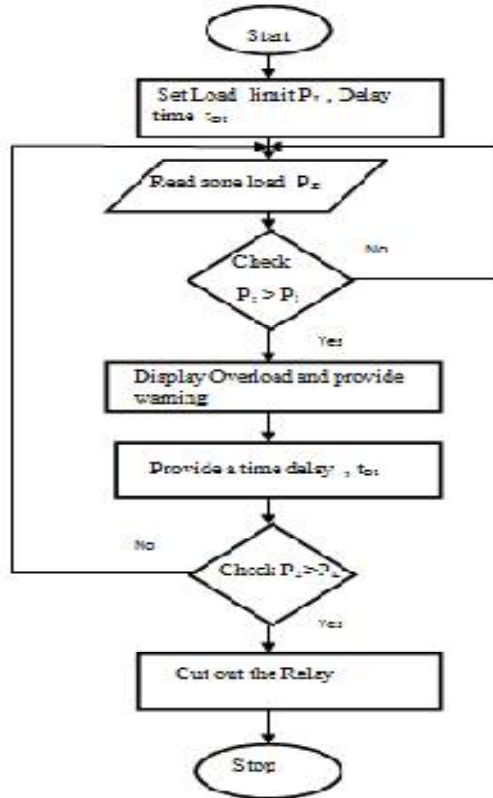

IV.COMPONENTS

1.ARMS LPC 2148

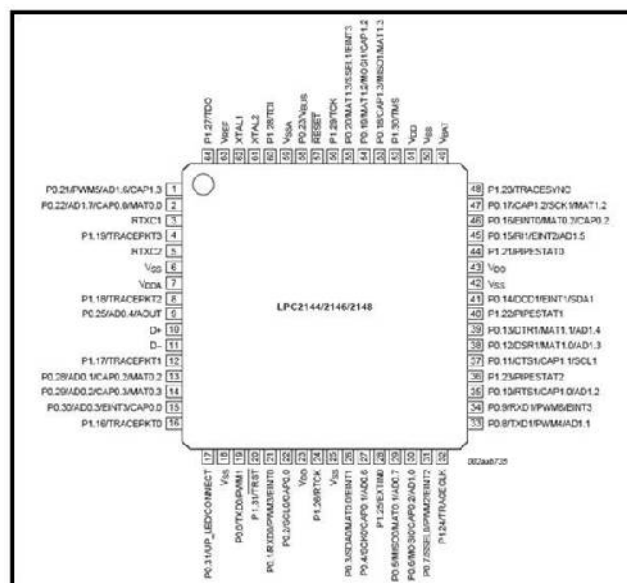

The LPC2148 microcontroller is based on a 16-bit/32-bit ARM7TDMI-S CPU with real-time emulation and embedded trace support, that combine the microcontroller with embedded high-speed ash memory ranging from 32 kB to 512 kB. A 128-bit wide memory interface and unique accelerator architecture enable 32-bit code execution at the maximum lock rate. Due to their tiny size and low power consumption, LPC2148 are ideal for applications where miniaturization is a key requirement, such as access control and point-of-sale. Serial communications interfaces ranging from a USB 2.0 Full-speed device, multiple UARTs, SPI, SSP to I2C-bus and on-chip SRAM of 8 kB up to 40 kB, make these devices very well suited for communication gateways and protocol converters, soft modems, voice recognition and low end imaging, providing both large buzzer size and high processing power.

2. CURRENT SENSOR ACS712

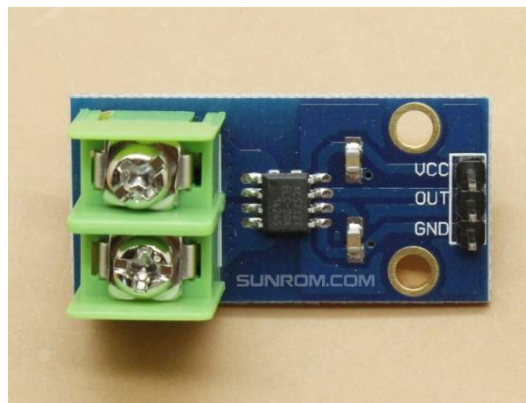

ACS712 current sensor operates from 5V and outputs analog voltage proportional to current measured on the sensing terminals. Sensing terminal can even measure current for loads operating at high voltages like 230V AC mains while output sensed voltage is isolated from measuring part. It provides up to 3000 VRMS galvanic isolation. The low-profile, small form factor packages are ideal for reducing PCB area over sense resistor op-amp or bulky current transformer configurations. The low resistance internal conductor allows for sensing up to 20 A continuous current. Providing typical output error of 1%.

3.ZCD

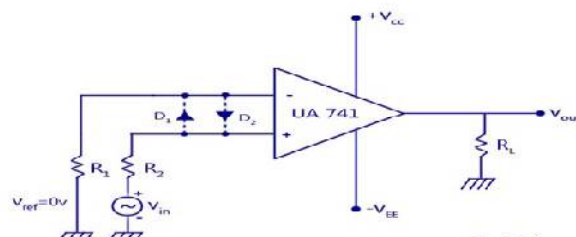

Zero crossing detector is a voltage comparator that changes the o/p between +Vsat & Vsat when the i/p crosses zero reference voltage. For an input sine wave, the output of the zero-crossing detector being a square wave. For a reference voltage 0V, when the input sine wave passes through zero and goes in positive direction, the output voltage Vout is driven into negative saturation. Similarly, when the input voltage passes through zero and goes in the negative direction, the output voltage is driven to positive saturation. The diodes D1 and D2 are also called clamp diodes. They are used to protect the op-amp from damage due to increase in input voltage. They clamp the differential input voltages to either +0.7V or -0.7V.

International Journal of Innovative Research in Science, Engineering and Technology

An ISO 3297: 2007 Certified Organization

Volume 6, Special Issue 6, March 2017

2ND National Conference on Future Technologies in Power, Control and Communication Systems (NFTPCOS-17)

23rd - 24th March 2017

Department of Electrical & Electronics Engineering, College of Engineering Perumon, Kollam, Kerala – 691601, India

V.CONCLUSION

The proposed paper can replace the conventional system in view of various aspects. It is useful for isolating fault affected zone and provides alternative supply to an emergency load from nearby healthy zone. A line man application incorporating effective authentication is developed which serves as a link between the utility and the lineman thereby facilitating the fault correction. The project also combines the benefits of Energy Management and Theft detection. The system controls demand by shedding loads whenever the load exceeds the peak limit. Before load shedding a warning to the consumers at that particular zone can be provided. The proposed system is also provided with an innovative scheme for theft detection and monitoring of electrical power theft in the electrical distribution system. Theft detection can be implemented by comparing the zone meter reading and sum of the meter readings of consumers in that zone

VI.FUTURE SCOPE

An efficient energy Management system can be introduced for each consumer by tracking meter readings of each consumer wirelessly and GPS can be attached ,which send the fault and theft location in terms of exact longitude and latitude. Improvements in human-machine interface and improvements in computer- based protection of Industry automation. Online monitoring can be done by incorporating

REFERENCES

- [1] " Automatic fault detection and location in power transmission lines using GSM technology " , Ing.Komi Agbesi , Felix Attuquaye Okai(2016)
- [2] " Distribution line fault detection and intimation using GSM " , International journal of Innovative Research in Science Engineering and Technology,2013
- [3] Electrical power theft detection and wireless meter reading " International Journal of Innovative Research in Science, Engineering and Technology,2013
- [4] A theoretical line losses calculation method of distribution system based on boosting algorithm International conference on natural computation ,fuzzy systems and Knowledge Discovery,2016