

# **Standalone Hybrid Renewable Energy System with Integrated Battery Storage System**

Pavan V<sup>1</sup>, Sridhar S<sup>2</sup>

M. Tech Student, Dept. of E&E, RNSIT, Bengaluru, India<sup>1</sup>

Asst. Professor, Dept. of E&E, RNSIT, Bengaluru, India<sup>2</sup>

**ABSTRACT:** To provide a continuous and efficient power supply to the residential loads from standalone PV system with online integrated battery storage system is proposed in these paper. An MPPT control system is used to extract maximum power from PV panel using DC-DC Bi-directional converter. The inverter provides a regulated ac output voltage to the load with an continue power supply. The PV cells, battery, and critical load have galvanic isolation from each other in the system. voltage fluctuations on load side has been reduced by a developed dual feedback control system is presented. The isolation decreases stress on the battery and improve UPS flexibility. The operation of this topology and the relevant developed control strategy were discussed in detail. Performance of the system is verified and approved using some simulations in MATLAB/Simulink.

**KEYWORDS:** Photovoltaic Micro-grid; Uninterruptible Power Supply (UPS); Isolated Battery Charger

## **I. INTRODUCTION**

Due to the decreasing of fossil fuels and environmental concerns, many countries encourages renewable energy based power generation. The mostly commonly used renewable energy for domestic purpose is PV energy. A PV system uses solar cells to directly convert the solar energy into electrical energy. In order to achieve accurate current rating of the system, PV strings are connected in parallel [1]. Although PV systems are of low maintenance and very reliable systems, there are some abnormal conditions for such systems which should be handled [2]. Partial shadowing of a string or dirty surface in a PV cell will intensely reduce the system output power [3], [4]. Therefore, in order to provide a reliable power with good quality an intermediate device is necessary. Also, an energy storage device is required to ensure power accessibility during night [3].

A PV-based Battery storage system consists of a DC-DC converter, a significant DC link capacitor, a three-phase inverter, an energy storage device that is usually a battery pack, and a bi-directional charger [9]. Combined Battery storage system and PV systems as a reliable energy storage system (ESS) can supply the required power during voltage fluctuations or interruption [7, 8]. There are also other types of energy storage such as flywheel, pumped storage and compressed air storage system [9].

Lead-Acid batteries, because of some considerations, have been extensively utilized in storage systems. These mentioned batteries have comparatively good response time and low cost, and deficiencies such as low life cycle, power density, and terminal voltage [10]. Recent developments in the Li-Ion battery technologies have improved their energy and power density and reduced volume and size. Therefore, they are rapidly override Lead-Acid batteries in most applications [10, 11]. According to the variety of batteries and their technologies, Li- Ion batteries have higher costs in compared with Lead-Acids but their cost is comparatively lower than FC and SC based systems [12-15].

In most on-line UPS systems, the batteries are stored the energy which is provided by the PV panel in normal operation and the stored energy can be given back during emergency situations or night. For the sake of safety considerations, electric isolation should be considered for battery charger [16]. Therefore, the desired isolation can be provided by using a High Frequency (HF) transformer.

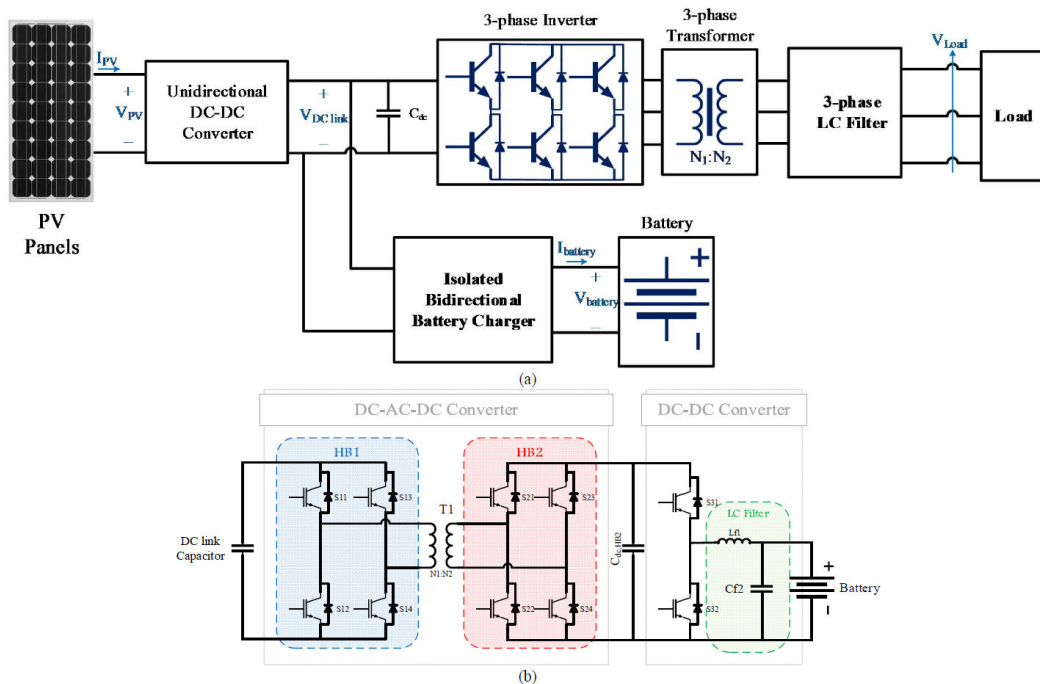

fig.1 proposed system configuration and control; a)overall topology;;b)isolated battery charger topology

In Fig. 1(a), the proposed Battery storage system-PV configuration is presented. The Boost converter and capacitor smooth out DC voltage fluctuations & boosts the voltage from the PV panels. A DC-DC converter is utilized to stabilize the PV output voltage and control the DC link voltage in normal operation. The provided DC voltage is converted to AC using a three-phase inverter. Galvanic isolation from the load is provided utilizing the three-phase step-up transformer. The transformer mainly adjusts the voltage to desired levels. In Fig. 1(b) the entire battery charger topology is depicted. The isolated battery charger utilizes a constant current discharging (CC) scheme. Since the batteries are charged with CC, their life cycle would be improved.

## II. LITERATURE SURVEY

1. **Perdue, M. and R. Gottschalg** , proposed “*Energy yields of small grid connected photovoltaic system: effects of component reliability and maintenance. Renewable Power Generation*” to explain The likelihood of system failure of small systems is investigated in order to establish the risk associated for the investment into a photovoltaic (PV) system for small domestic applications. This is achieved by reviewing existing literature on PV system failure rates and using these as an input for a statistical PV system yield simulation tool that considers failure and repair. It is typically assumed that these systems do not require any maintenance, but it is shown that this will have near catastrophic impact on the energy production of PV systems. The no maintenance is not a likely scenario, as small systems have to register their generation to achieve a feed-in-tariff. In a later stage, when PV is used for self-consumption only, this may change but in the present market most users are forced to carry out a quarterly check and thus this catastrophic failure is avoided by the need of having to apply for the feed-in-tariff. Minimum maintenance strategies for ensuring profitable system operation are investigated and their cost-effectiveness is discussed. It is shown that the present situation where many systems are neither monitored nor is any maintenance carried out results in a high probability of unsuccessful system operation as failure detection may take a very long time. Successful system operation here is defined as not recovering the financial investment. It would be advisable to carry out at least monthly

# International Journal of Innovative Research in Science, Engineering and Technology

(A High Impact Factor, Monthly, Peer Reviewed Journal)

Visit: [www.ijirset.com](http://www.ijirset.com)

Vol. 7, Issue 4, April 2018

performance checks as otherwise it is likely to have more than 10% energy lost because of system downtime. This requires, however, availability of irradiance data as otherwise it is not possible to identify whether low yields are due to resource issues or really system yield issues.

2. **Kim, H., et al.**, proposed “*Reconfigurable solar converter: a single-stage power conversion PV-battery system*” in that paper they introduces a new converter called reconfigurable solar converter (RSC) for photovoltaic (PV)-battery application, particularly utility-scale PV-battery application. The main concept of the new converter is to use a single-stage three-phase grid-tie solar PV converter to perform dc/ac and dc/dc operations. This converter solution is appealing for PV-battery application, because it minimizes the number of conversion stages, thereby improving efficiency and reducing cost, weight, and volume. In this paper, a combination of analysis and experimental tests is used to demonstrate the attractive performance characteristics of the proposed RSC.
3. **Jin-Hee, Y., J. Ku-In, and K. Jung-Min** proposed to prove that an energy storage system (ESS) with a photovoltaic (PV) generation and an on-line uninterruptible power supply (UPS) functions is composed of an inverter, a bidirectional converter, a PV converter, and a battery converter. The inverter provides a regulated sinusoidal output voltage to the load like the on-line UPS. The bidirectional converter operates as an inverter or a rectifier to transmit the power to and from the grid. The PV converter extracts the maximum power from the PV panels and sends it to the DC-bus. The battery converter is connected in parallel with the DC-bus.

### III. SYSTEM BASIC OPERATION AND CONTROL STRATEGY

.Basically, Battery storage system works completely different in normal and fault condition. In normal operation, the load demands are provided by PV and the batteries are charged through the charger. When a fault occurs or in partial shading situations, PV and Battery is separated from each other and the load demands are provided by batteries through the bidirectional charger.

A. Normal Operation: While the system operates in normal mode PV can be supplied both load and batteries. The PV and Battery supply a high quality power for the load. While the sufficient irradiance is accessible, the batteries are charged by using a suitable charging method. If irradiance is not enough to supply the load, PV would supply part of the load, while battery supplies the rest.

The DC link capacitor and converter inductor acts as a low pass filter & decreases the dc ripple voltages. The DC voltage is inverted to three-phase AC voltage with SUPWM utilizing the three-leg inverter. Fig.2 displays the control diagram of the three-phase inverter. As shown in Fig 2, inverter modulation index ( $ma$ ) is improved continually using appropriate feedback outputs to diminish voltage fluctuations. To obtain the reference signals for the SUPWM controller, the three-phase signals is multiplied by  $ma$ .

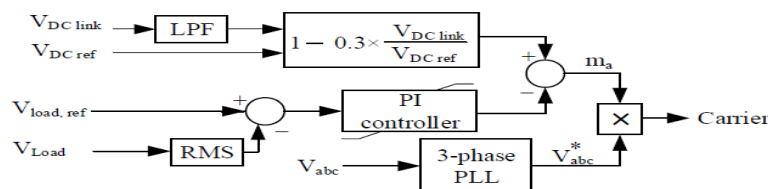

fig 2; control diagram of the three-phase inverter

In charging mode, DC-DC converter works as a buck converter and handles the current which is charging the batteries. As seen in Fig. 4, control block of DC-DC converter when it works as a buck converter is presented. In Fig. 4, charge signal represents the batteries state and when the charge-signal value is one it means the batteries become full and charging operation stops.

# International Journal of Innovative Research in Science, Engineering and Technology

(A High Impact Factor, Monthly, Peer Reviewed Journal)

Visit: [www.ijirset.com](http://www.ijirset.com)

Vol. 7, Issue 4, April 2018

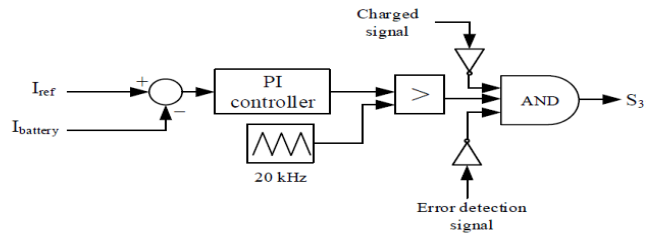

fig 4; DC-DC converter control diagram during buck operation

While battery is charging the first stage of the isolated battery charger which is the H-Bridge1 (HB1) acts as an inverter and the second one the HB2, is a rectifier. The high-frequency transformer is chosen because of two reasons, one of them is providing electric isolation and the other is because of proper voltage ratio that is these transformers have for energy conversation between battery and capacitor of DC link. In Fig. 3, control block of the DC-AC-DC converter is illustrated. For simplicity, a Square Wave PWM (SWPWM) scheme with 50% duty cycle is chosen for the inverter operation.

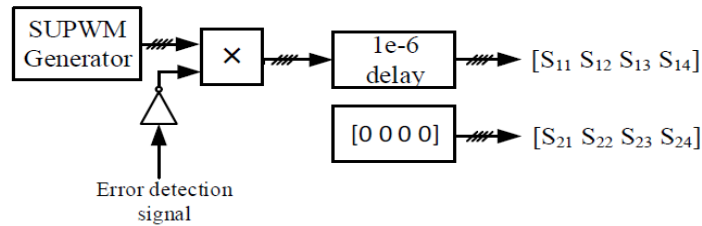

fig 3; control diagram of DC-AC-DC converter

### B. Fault Condition

In fault condition is that PV and Battery is separated from each other and the required load demands are provided by batteries. As soon as a fault occurrence, a switch turns open and by that, the PV is separated from the DC link capacitor. In fault condition, to keep DC link voltage at suitable level, voltage of batteries should be increased to a reference value using the DC-DC converter. Furthermore, to realize the CC discharging scheme, a single loop PI controller is not an appropriate choice.

In the period of fault and normal condition control diagram of the DC-AC-DC converter is the same though HB1 and HB2 changes their duties. HB1 and HB2 control diagram is depicted in Fig. 5. As shown in Fig. 6, firstly the DC-DC converter output voltage is measured and then the obtained error signal is feed the first PI controller.

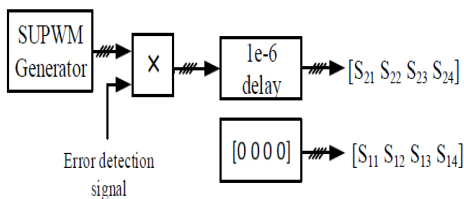

fig 5; Control diagram of HB1 & HB2

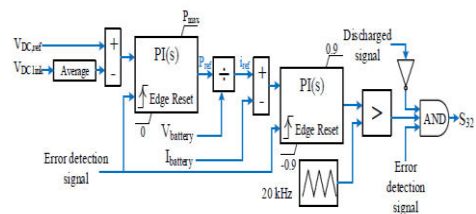

fig 6; DC-DC converter during fault condition

# International Journal of Innovative Research in Science, Engineering and Technology

(A High Impact Factor, Monthly, Peer Reviewed Journal)

Visit: [www.ijirset.com](http://www.ijirset.com)

Vol. 7, Issue 4, April 2018

## IV. CONSIDERATION DESIGN

With considering of some issues like cost, size, and efficiency, the system parameters are chosen. The characteristics and the parameters of the suggested UPS are displayed in Table I and Table II shows PV system parameters.

Table 1 PV-UPS system characteristics

Parameters	Value	Unit
Input AC Voltage (RMS)	380	V
AC input frequency	50	Hz
Max. Input AC current	10	A
Desired DC link voltage	515	V
Output DC voltage ripple	2	V
Max. Battery charging current	5	A
Max. Output DC current ripple	0.1	A
Max. Output power	6.5	KW
PWM switching frequency (fs)	20	KHz
PV nominal voltage	320	V
PV nominal current	25	A

Table 2 PV panel specification

Parameters	Value	Unit
Number series strings	5	-
Number parallel strings	5	-
Module type	Sun power SPR-305-WHT	
Module parameters	515	V
Cells per string	96	-
Open circuit voltage	64.2	V
Short circuit current	5.96	A
MPP voltage	54.7	V
MPP current	5.58	A

## V. SIMULATION RESULTS

To approve the correctness of the presented charger topology and also to evaluate the suggested UPS feasibility, computer simulations were done and the results are obtained by utilizing MATLAB/Simulink software. Table III shows specifications of the simulated system.

## International Journal of Innovative Research in Science, Engineering and Technology

(A High Impact Factor, Monthly, Peer Reviewed Journal)

Visit: [www.ijirset.com](http://www.ijirset.com)

Vol. 7, Issue 4, April 2018

Table 3 Table simulated system components

Components	Value	Unit
Diode forward voltage	0.8	V
Diode conduction resistance	0.001	$\Omega$
IGBT conduction resistance	0.005	$\Omega$
Charging resistor	2	$\Omega$
DC link capacitor	5	mF
$C_{dc,hb2}$	0.5	mF
Lf1	125	$\mu$ H
RLf1	0.5	$\Omega$
Cf1	3.12	mF
Lf2	1	mH
RLf2	0.2	$\Omega$
Cf2	1.05	$\mu$ F
P load	4500	Watt
Q load	500	Var

A) Normal operation

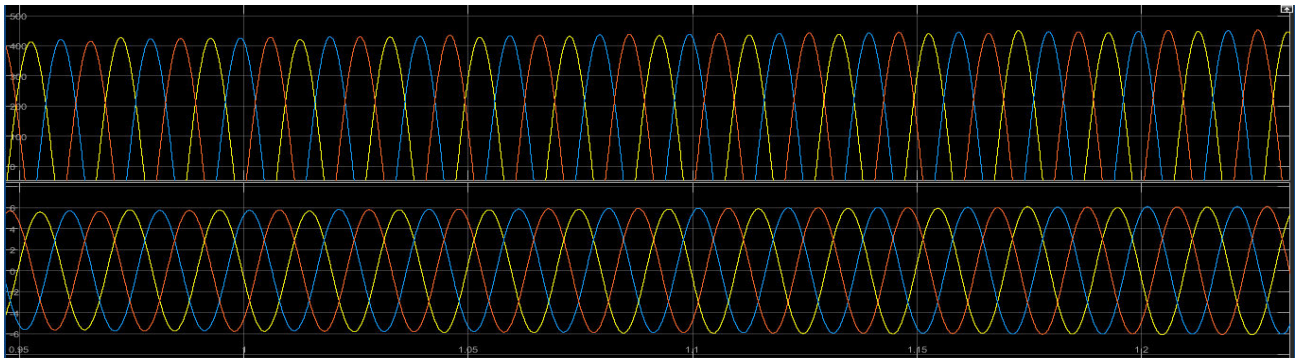

fig 7; Load voltage and current waveforms

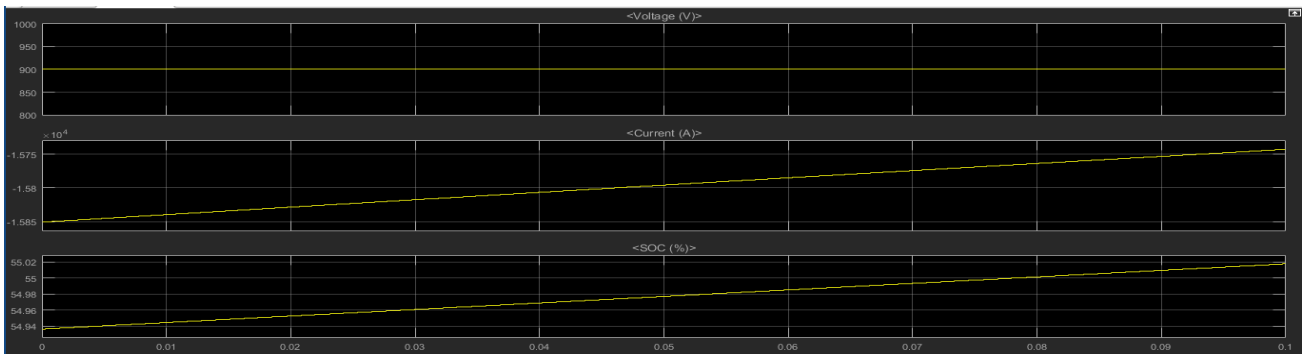

fig 8; a) Battery voltage; b) Battery current; c) Battery soc

**B. Fault Condition**

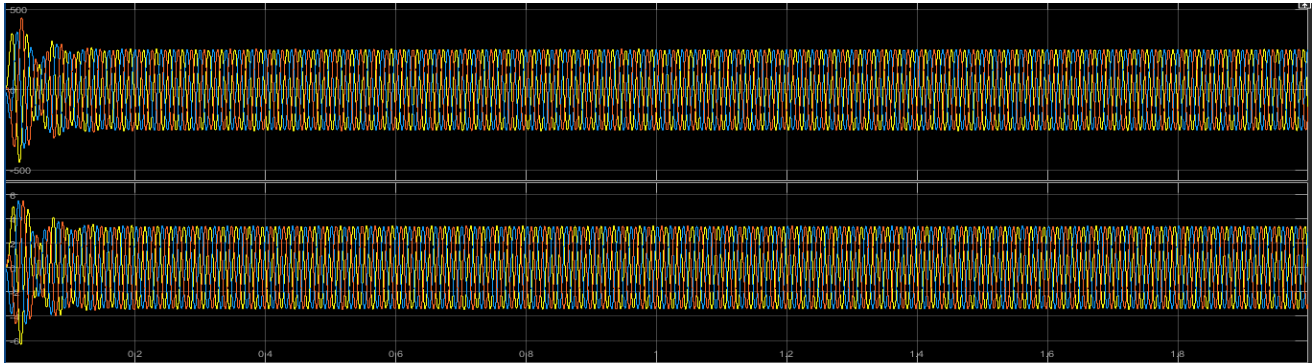

fig 8; Load voltage and current waveforms

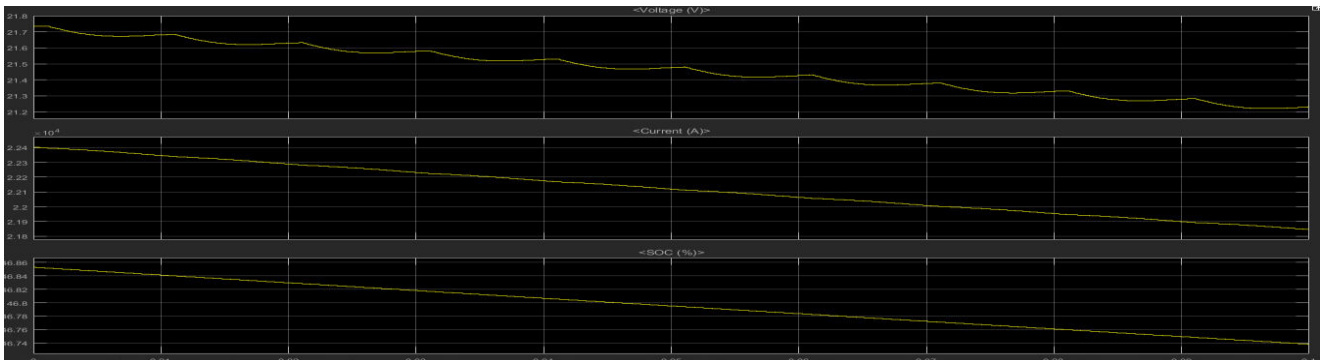

fig 9; a) a)Battery voltage; b)Battery current; c) Battery soc

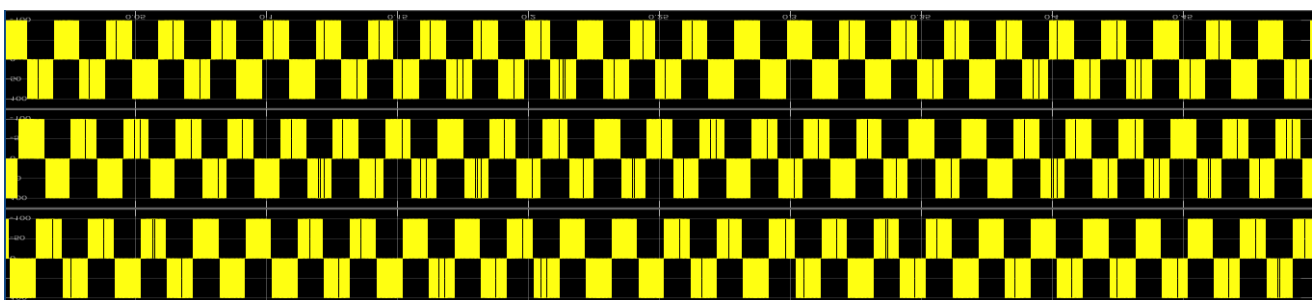

fig 10; SPWM Inverter output voltage

**VI. CONCLUSION**

In this study, a PV system with an integrated three-phase online battery storage system was suggested. In order to diminish voltage fluctuations at load side, a developed dual feedback control approach for inverter was presented. After that, the DC voltage is transformed into AC by utilizing a three-phase inverter. The operation of this topology and the relevant developed control strategy were explained. The simulation results in MATLAB/Simulink software approve battery performance.

# International Journal of Innovative Research in Science, Engineering and Technology

(A High Impact Factor, Monthly, Peer Reviewed Journal)

Visit: [www.ijirset.com](http://www.ijirset.com)

Vol. 7, Issue 4, April 2018

## REFERENCES

- [1] Velasco-Quesada, G., et al., Electrical PV Array Reconfiguration Strategy for Energy Extraction Improvement in Grid-Connected PV Systems. *Industrial Electronics, IEEE Transactions on*, 2009. 56(11): p. 4319-4331.
- [2] Perdue, M. and R. Gottschalg, Energy yields of small grid connected photovoltaic system: effects of component reliability and maintenance. *Renewable Power Generation, IET*, 2015. 9(5): p. 432-437.
- [3] Kim, H., et al., Reconfigurable solar converter: a single-stage power conversion PV-battery system. *Power Electronics, IEEE Transactions on*, 2013. 28(8): p. 3788-3797.
- [4] Pan, X., A.K. Rathore, and U.R. Prasanna, Novel Soft-Switching Snubberless Naturally Clamped Current-Fed Full-Bridge Front-End-Converter-Based Bidirectional Inverter for Renewables, Microgrid, and UPS Applications. *Industry Applications, IEEE Transactions on*, 2014. 50(6): p. 4132-4141.
- [5] Santiago Maciel, R., et al., Front-End Converter With Integrated PFC and DC-DC Functions for a Fuel Cell UPS With DSP-Based Control. *Power Electronics, IEEE Transactions on*, 2015. 30(8): p. 4175-4188.
- [6] Milad, M. and M. Darwish. UPS system: How can future technology and topology improve the energy efficiency in data centers? in *Power Engineering Conference (UPEC), 2014 49th International Universities*. 2014.
- [7] Emadi, A., Abdolhosein Nasiri, and Stoyan B. Bekiarov, *Uninterruptible power supplies and active filters*. 2004: CRC press.
- [8] Dehong, X., et al. A fuel cell uninterruptible power supply (FC-UPS) system. in *Power Electronics Systems and Applications (PESA), 2013 5th International Conference on*. 2013.
- [9] Jin-Hee, Y., J. Ku-In, and K. Jung-Min. Energy storage system with PV generation and on-line UPS functions. in *Telecommunications Energy Conference (INTELEC), 2014 IEEE 36th International*. 2014.
- [10] Stan, A.I., et al. A comparative study of lithium ion to lead acid batteries for use in UPS applications. in *Telecommunications Energy Conference (INTELEC), 2014 IEEE 36th International*. 2014.
- [11] Lu, L., et al., A review on the key issues for lithium-ion battery management in electric vehicles. *Journal of Power Sources*, 2013. 226: p. 272-288.
- [12] Alessandro, F., et al. UPS Fuel Cell Based: an innovative back-up system. in *Clean Electrical Power, 2007. ICCEP '07. International Conference on*. 2007.
- [13] Sedighzadeh, M. and A. Rezazadeh, Comparison between batteries and fuel cells for photovoltaic system backup. *reactions*, 2007. 3: p. 5.
- [14] Lahyani, A., et al., Battery/Supercapacitors Combination in Uninterruptible Power Supply (UPS). *Power Electronics, IEEE Transactions on*, 2013. 28(4): p. 1509-1522.
- [15] Du Pasquier, A., et al., A comparative study of Li-ion battery, supercapacitor and nonaqueous asymmetric hybrid devices for automotive applications. *Journal of Power Sources*, 2003. 115(1): p. 171-178.
- [16] Yilmaz, M. and P.T. Krein, Review of Battery Charger Topologies, Charging Power Levels, and Infrastructure for Plug-In Electric and Hybrid Vehicles. *Power Electronics, IEEE Transactions on*, 2013. 28(5): p. 2151-2169.