

Design and Implementation of Automated Blood Bank Using Embedded Systems

Lokeswari.S¹, Navya Sree.B²,Rishikaa.M.D³, Saranya.A⁴ and A.S.Rashmi⁵

UG Scholar, Department of ECE,Adhiyamaan College of Engineering, Hosur, Tamilnadu, India^{1,2,3,4}

Associate Professor, Department of ECE, Adhiyamaan College of Engineering, Hosur, TN, India⁵

ABSTRACT: Every year the nation requires about 4Crore units of blood, out of which only a meager 40Lakh units of blood are available. There are multiple blood banks around the world , however none of them offer the capability for a direct contact between the donor and recipient. This is often a serious disadvantage notably in cases wherever there is associate degree pressing would like of blood. This project aims to beat this communication barrier by providing an immediate link between the donor.

KEYWORDS: Button, Micro controller, GSM,LCD display etc.

I. INTRODUCTION

Blood is one of the most critical elements and it's truly referred to as 'river' of life. There are number of scenarios where urgent need of blood comes. At these critical time, the online blood bank with has an automatic call routing facility will be of great aid. We here intend to achieve this through the direct call routing function. An algorithm is defined to find the suitable donor at every point of time. This kind of a system is more advantageous compared to present systems available as immediate contact with the donor is provided every time. This helps in getting an immediate response than a messaging based system or simply internet based database system. An immediate fulfillment of the blood requirement is possible in this system. available. There are multiple online blood banks around the world, however none of them offer the capability for a direct contact between the donor and recipient. This is often a serious disadvantage in cases wherever there is associate degree pressing would like of blood. This project aims to beat this type of communication barrier by providing an immediate link between the donor and the recipient. "Automated Blood Bank" proposes to bring voluntary blood donors and those in need of blood on to a common platform.

The main objective of proposed work is servicing the persons who seek donors who are willing to donate blood and also provide it within the time frame. Every year the state needs regarding 4crore units of blood, out of that solely a meagre 40Lakh units of blood square measure out there. Every two seconds somebody desires blood. More than thirty eight thousand blood donations area unit is required per day. A complete of thirty million blood parts area units transfused annually.



Fig 1: Global System for Mobile Communication(GSM)

II. RELATED WORK

All communication takes place via SMS (Short Messaging Service) which is compatible with almost all mobile types. "Automated Blood Bank" proposes to bring voluntary blood donors and those in need of blood on to a common platform. This project is originated on an android APP, this will help to find the donors. Blood donor will participate in donor list using APP. Suppose if any need in blood, will get the donor list in this APP. Here in this APP, only 3 Blood group (A+, B+, O+) Data base is established. The recent interested donor number will be available in the data base. This project uses GSM modem interfaced to the controller i.e LPC2148. GSM is interfaced through the MAX232 to the Controller.

III. EXSTING SYSTEM

Blood bank management system: At present, the public can only know about the blood donation events through conventional media means such as radio, newspaper or television advertisements. There is no information regarding the blood donation programs available on any of the portal. The current system that is using by the blood bank is manual system. With the manual system, there are problems in managing the donors' records. The records of the donor might not be kept safely and there might be missing of donor's records due to human error or disasters. Besides that, errors might occur when the staff keeps more than one record for the same donor. There is no centralized database of volunteer donors. So, it becomes really tedious for a person to search blood in case of emergency. The only option is to manually search and match donors and then make phone calls to every donor. There is also no centralized database used to keep the donors' records. Each bank is having their own records of donors. If a donor makes donation in different hospital, no previous records can be traced except if the donor brings along the donation certificate. Hence, the donor is considered to be a first timer if they make blood donation in a new place. Without an automated management system, there are also problems in keeping track of the actual amount of each and every blood type in the blood bank. In addition, there is also no alert available when the blood quantity is below its par level or when the blood in the bank has expired.

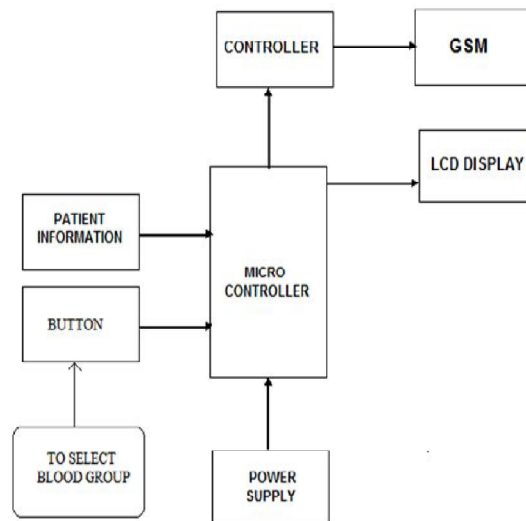

Fig 2: Block diagram of automated blood bank system

IV. PROPOSED SYSTEM

One has to download the application. After downloading the application one has to register as a donor if want donate the blood. For registration some basic details like Name, address, contact, date of birth, blood group, email id etc are needed. If already register, then he/she has to login. The user can also request for required blood by giving any small description. This request is submitted to admin who accepts or rejects the request. Accepted request is published by admin. By using GPS, victim can searches nearby hospitals and blood banks.

The proposed system consists of mainly five modules-Admin, Donor, Acceptor, System database, App.

ADMIN

Admin is the person who monitors the information related to donor and acceptor. Administrator can change password, Maintain donor details. Maintain acceptor details, Update donor details, etc.

DONOR

Each new Donor has to register himself. For unique identification of the donor user id and password are provided after registration. Ach Donor has to fill all the basic details likename, date of birth, address, gender.

ACCEPTOR

Acceptor is the person who needs blood for someone related with him. He can make the request for the blood through application and website according to their blood group and requirement.

SYSTEM DATABASE

It stores all necessary and important information related to donor, acceptor and patient. There will be an option for updating the information related to users which helps in tracking and managing information.

BLOOD DONATION APP

An android application created for making request for blood by checking the availability of the blood in different blood banks and for donating blood. It is also used for searching the nearby banks and hospital.

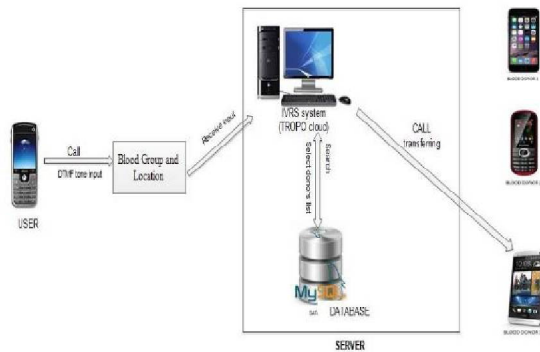

Fig 3: Architecture of the proposed system

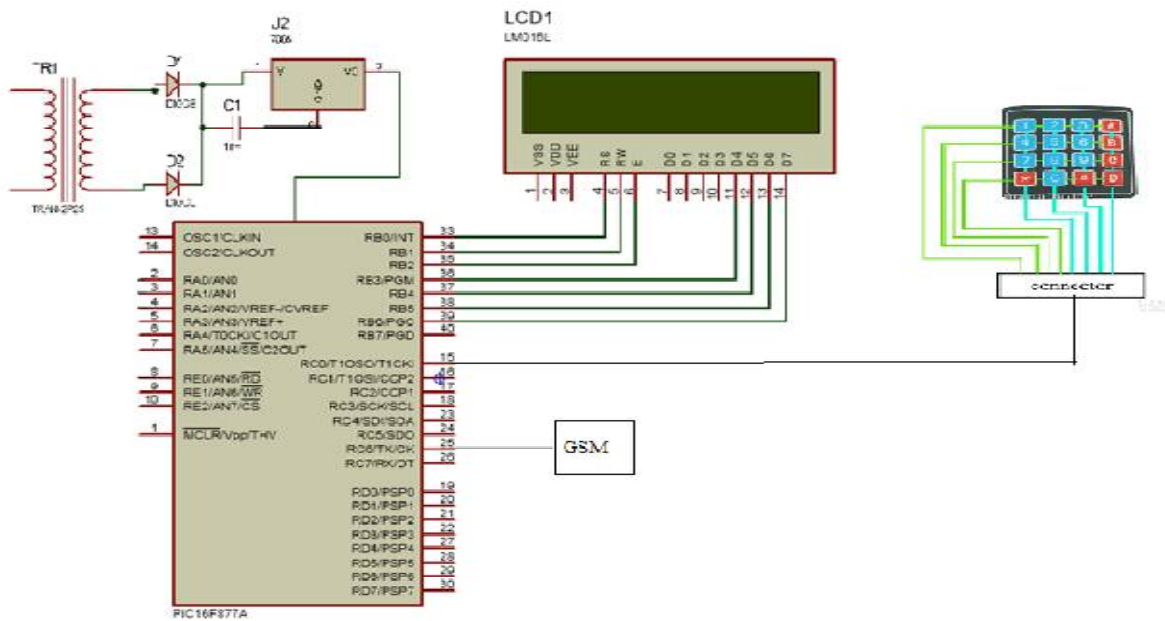

Fig 4: circuit diagram

GLOBAL SYSTEM FOR MOBILE COMMUNICATION (GSM)

DEFINITION

GSM, which stands for Global System for Mobile communications, reigns (important) as the world's most widely used cell phone technology. Cell phones use a cell phone service carrier's GSM network by

searching for cell phone towers in the nearby area. Global system for mobile communication (GSM) is a globally accepted standard for digital cellular communication.



Fig 5: GSM operation

V. RESULT



Fig. 1. Home Page & Login Page

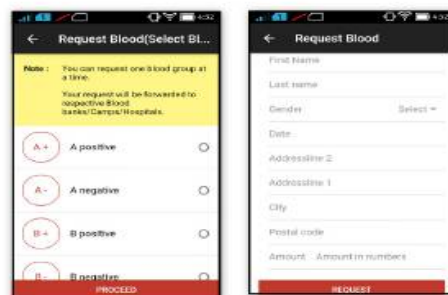

Fig. 2. Request Blood

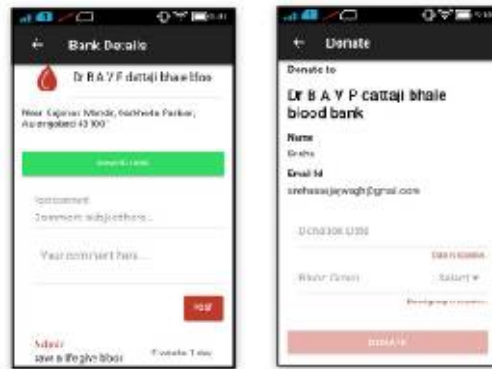

Fig. 3. Donate Blood

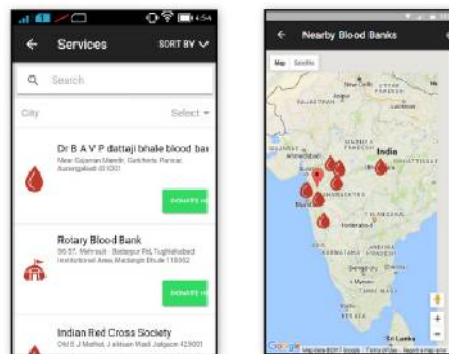

Fig. 4. Nearest Blood Banks

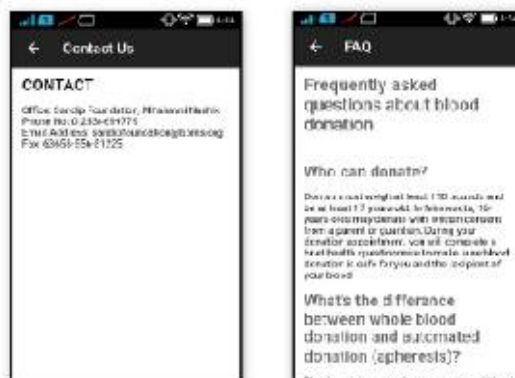

Fig. 5. Contact and FAQ's

International Journal of Innovative Research in Science, Engineering and Technology

An ISO 3297: 2007 Certified Organization

Volume 7, Special Issue 1, March 2018

6th National Conference on Frontiers in Communication and Signal Processing Systems (NCFCSPPS '18)

13th-14th March 2018

Organized by

Department of ECE, Adhiyamaan College of Engineering, Hosur, Tamilnadu, India

VI.CONCLUSION

Blood is the primary necessity of life. There are different scenarios available for searching blood donors. This proposed system will be one step ahead from the other blood donation systems. Blood recipient can contact the blood donor directly by using this system.

REFERENCES

- [1] Arif. M. Sreevas. S. Nafseer. K. and Rahul. R., „Automated online Blood bank database“, India Conference (INDICON), Annual IEEE, Print ISBN: 978-1-4673-2270-6, pp. 012 – 017, 2012.
- [2] BalaSenthilMurugan L, Anitha Julian, “Design and Implementation of Automated Blood Bank using Embedded Systems”, International Conference on Circuit, Power and Computing Technologies [ICCPCT], 2015.
- [3] Kapicak L, Nevlud P, Zdralek J, Dubec P, Plucar J, "Remote control of Asterisk via Web Services", 34th International Conference on Telecommunications and Signal Processing (TSP), 2011.
- [4] Peter Marbach, Oliver Mihatsch, and John N.Tsitsiklis, "Call Admission Control and Routing in Integrated Services Networks Using Neuro-Dynamic Programming", IEEE Journal on selected areas in communications, VOL.18, NO.2, February 2000.
- [5] R Vanitha M.E, P Divyarani, “BCloud App: Blood Donor Application for Android Mobile”, International Journal of Innovations in Engineering and Technology (IJIET), Vol. 2 Issue 1 February 2013.
- [6] Nader Moayeri, Jalal Mapar, Stefanie Tompkins, KavehPahlavan, “Emerging opportunities for localization and tracking”, IEEE Wireless Communications, April 2011.