



e-ISSN: 2319-8753 | p-ISSN: 2347-6710

IJRSET

International Journal of Innovative Research in
SCIENCE | ENGINEERING | TECHNOLOGY



INTERNATIONAL JOURNAL OF INNOVATIVE RESEARCH

IN SCIENCE | ENGINEERING | TECHNOLOGY

Volume 10, Issue 8, August 2021

ISSN INTERNATIONAL
STANDARD
SERIAL
NUMBER
INDIA

Impact Factor: 7.569

9940 572 462

6381 907 438

ijrset@gmail.com

www.ijrset.com



Hydrodynamic Analysis & Design of Elevated Service Reservoir Using Composite Column

Sunil Dhananjay Rathod¹ Prof. V.V.Shelar²

P.G. Student, (ME Structures) Department of Structural Engineering, Trinity College of Engineering and Research, Pune, India¹

Associate Professor, KJEI's Trinity College of Engineering and Research, Pune, India²

ABSTRACT: This paper presents the comparative equivalent static and time history analysis of elevated encased composite column water tank during earthquake. The RCC column staging of elevated water tank can be replaced by an encased composite column staging water tank, because the RCC water tank developed cracks during earthquake, resulting in loss of strength and stiffness, so increase performance of elevated water tank during earthquake to study the behavior of composite elevated water tank. Therefore the parametric studies on mathematical model of six water tanks are created in ETABS software. These are both tanks have been created in an ETABS for a different height from ground level. The Indian draft code part II of IS 1893:2002 which has provision of elevated water tank. The equivalent analysis with regards to time periods, base shear, and storey stiffness displacement against height and storey drift.

KEYWORDS: Pushover, ETABS, Performance Point, Non-linear

I. INTRODUCTION

The significant social and economic impacts of recent earthquakes affecting urban areas have resulted in an increased awareness of the potential seismic hazard and the corresponding vulnerability of the existing elevated storage water tank required for estimating seismic risk. Greater effort has been made to estimate and mitigate the risks associated with these potential losses. In order to successfully mitigate potential losses and to aid in post-disaster decision-making processes, the expected damage and the associated loss in urban areas caused by earthquakes should be estimated with an acceptable degree of certainty. Seismic loss assessment depends on the comprehensive nature of estimating vulnerability. The determination of vulnerability measure requires the assessment of the seismic performances of elevated water tanks typically constructed in an urban region when subjected to a series of earthquakes, taking into account the particular response characteristics of each structural type. The fragility study generally focuses on the generic types of construction because of the enormity of the problem. Hence, simplified structural models with random properties to account for the uncertainties in the structural parameters are used for all representative structure types.

II. ALTERNATIVE CONSTRUCTION TECHNIQUES

There are various techniques used for the fulfillment of demand of construction industry. Some of them are popular due to availability of men, material & money, some of them are popular due to their practicality of design.

There are mainly three types of construction techniques used for the high rise buildings construction and these are:

- RCC Construction
- Steel Structures
- Composite or hybrid Construction

Composite construction

Nowadays composite is famous one in foreign countries due to their suitability in construction, also it overcomes the disadvantages of RCC & Steel construction which make the composite or hybrid beneficial for high rise construction though the composite resists lateral forces more effectively compared to the RCC & steel.

In composite structure the advantage of bonding property of steel and concrete is taken into consideration so that they will act as a single unit under loading. These essentially different materials are completely compatible and complementary to each other; they have almost the same thermal expansion; they have an ideal combination of strengths with the concrete efficient in compression and the steel in tension; concrete also gives corrosion protection

and thermal insulation to the steel at elevated temperatures and additionally can restrain slender steel sections from local or lateral-torsional buckling. In conventional composite construction, concrete rests over steel beam and under loading conditions these two component acts independently and a relative slip occurs at the interface of concrete slab and steel beam, which can be eliminated by providing appropriate connection between them. So that steel beam and slab act as composite beam and gives behavior same as that of Tee beam.

In steel concrete composite sections both steel and concrete resists external loads together and helps to limit sway of the building frame. It should be added that the combination of concrete cores, steel frame and composite floor construction has become the standard construction method for multi-story commercial buildings in several countries. The main reason for this preference is that the sections and members are best suited to resist repeated earthquake loadings, which require a high amount of resistance and ductility.

Composite Frame Element

A composite member is constructed by combining concrete member and steel member so that they act as a single unit. As we know that concrete is strong in compression and weak in tension on the other side steel is strong in tension and weak in compression. The strength of concrete in compression is complemented by strength of steel tension which results in an efficient section. By the concept of this composite member the concrete and steel are utilized in well-organized manner.

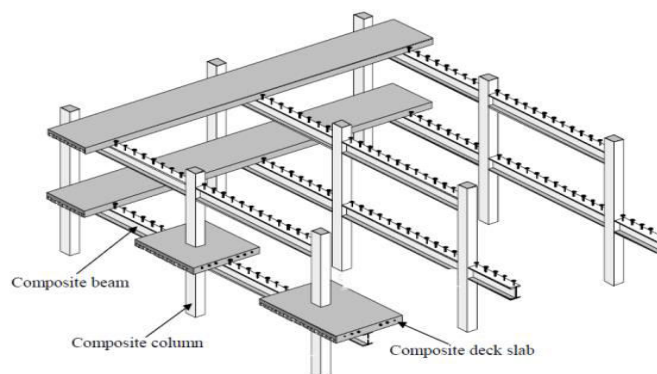

Fig no.1: Composite Frame

Composite Element-

The primary structural components used in composite construction consist of the following elements.

- a. Composite Slab
- b. Composite Beam
- c. Composite Column
- d. Shear Connector

III. METHODOLOGY

To perform the proposed project work it is necessary to adopt the proper methodology, which can help to meet the requirement of the proposed objective of this work in all respects. It also provides the base and gives the strong support for this work. It contains theoretical concepts, design philosophy & analysis of members etc.

Methods of Analysis

Seismic Analysis

Seismic analysis is a subset of structural analysis and is the calculation of the response of a building (or non-building) structure to earthquakes. It is part of the process of structural design, earthquake engineering or structural assessment and retrofit (see structural engineering) in regions where earthquakes are prevalent.

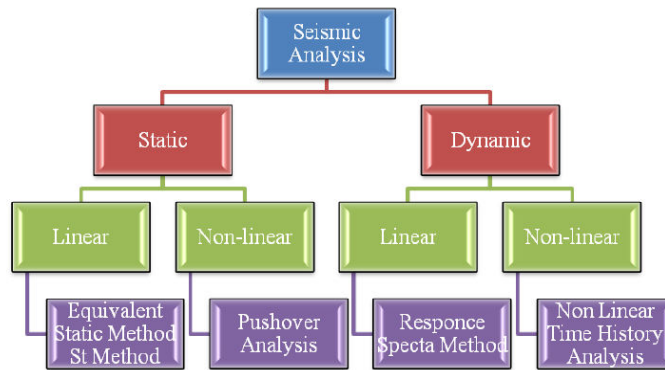
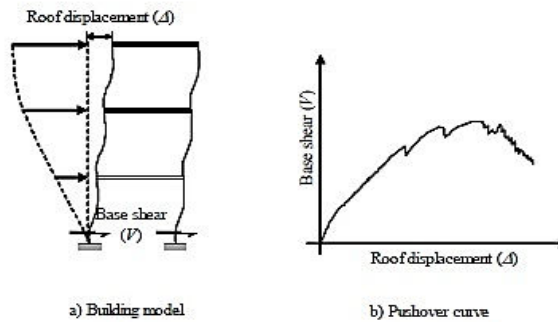

Fig. No-2 Tree Diagram of Seismic Analysis

Pushover analysis (Non-Linear Static Analysis)

This is the important chapter in this project work considering meeting the requirement of proposed objective. This chapter gives the information regarding pushover analysis which is going to be performing using ETABs. It describes the concept of pushover analysis which is helpful in understanding the phenomena of building performance during its performance.

- Pushover analysis is a static, nonlinear procedure using simplified nonlinear technique to estimate seismic structural deformations.
- It is an incremental static analysis used to determine the force-displacement relationship, or the capacity curve, for a structure or structural element.
- The intensity of the lateral load is slowly increased and the sequence of cracks, yielding, plastic hinge formation, and failure of various structural components is recorded.
- The process continues until the design satisfies pre-established performance criteria. The performance criteria for pushover analysis are generally established as the desired state of the building given roof-top or spectral displacement amplitude.
- Pushover analysis is a simplified nonlinear analysis whose central focus is generation of the pushover curve or capacity curve.



A predefined lateral load pattern as shown in fig. which is distributed along the building height is then applied. The lateral forces are increased until some members yield.

The structural model is modified to account for the reduced stiffness of yielded members and lateral forces are again increased until additional members yield. The process is continued until a control displacement at the top of building reaches a certain level of deformation or structure becomes unstable.

Purpose

The purpose of pushover analysis is to evaluate the expected performance of structural systems by estimating performance of a structural system by estimating its strength and deformation demands in design earthquakes by means of static inelastic analysis, and comparing these demands to available capacities at the performance levels of interest. The evaluation is based on an assessment of important performance parameters.

Necessity

The existing building can become seismically deficient, since seismic design code requirements are constantly upgraded and advancement in engineering knowledge. Further, Indian buildings built over past two decades are seismically deficient because of lack of awareness regarding seismic behaviour of structures. The widespread damage especially to RC buildings during earthquakes exposed the construction practices being adopted around the world, and generated a great demand for seismic evaluation of existing building.

Design Parameters

1. Total load
2. Base shear
3. Storey displacement
4. Storey drift
5. Pushover curve

IV. EXPERIMENTAL RESULTS

For the study, elevated service reservoir analyzed with different staging heights are considered; each water tank is modelled as Reinforced cement concrete, Concrete filled tube and Encased Composite Column water tank.

The models which are used in this report is 12m staging height from the ground level. The above models are analyzed for static and Time History records of earthquake such as Kobe, Bhuj. The comparative static analysis of both tank for hard soil and seismic zone V.

Geometric & material properties

Description	RCC structure	Composite structure
Plan dimension	5.95m X 5.95m	5.95m X 5.95m
Total height	19m	19m
Depth of footing	2m	2m
Size of beam	200mm X 300mm 200mm X 450mm 200mm X 600mm	200mm X 300mm 200mm X 450mm 200mm X 600mm
Size of column	RCC 600mm Dia	CFT 450mm Dia CIS 450X450 mm
Slab thickness	200mm 150mm	200mm 150mm
Bottom slab thickness	250mm	250mm
Side wall thickness	200mm	200mm
Dead load	Self weight	Self weight
Live load	1.5KN/m ²	1.5KN/m ²
Hydrodynamic load (Max. at Bottom)	45KN/m ²	45KN/m ²
Seismic zone	IV	IV
Soil condition	Medium	Medium
Response reduction factor	5	5
Importance factor	1.5	1.5
Zone factor	0.24	0.24
Grade of concrete	M30	M30
Grade of steel	Fe500	Fe500
Damping ratio	5%	5%

Geometrical Details of water tank

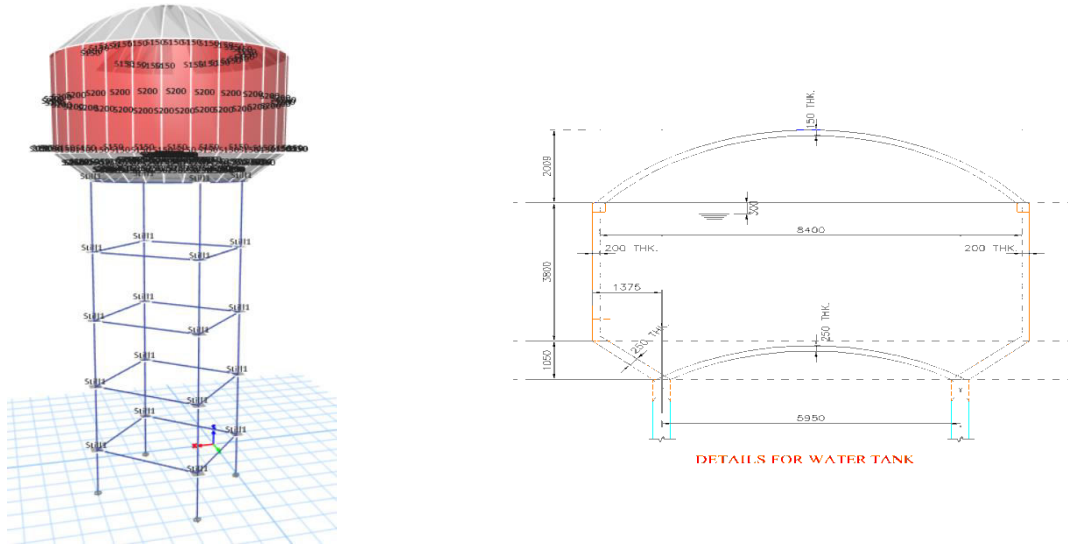

Fig.3 Geometrical layout for water tank

2.4.1 Dead load

It is the total dead load of frame. Results show that the total load of CFT is maximum as compare to the steel-concrete composite frame which is given in table no. 2

SR. NO	STRUCTURE WITH COLUMN PROFILE	TOTAL WEIGHT (KN)
1	RC COLUMN	1905.73
2	CFT COLUMN	1882.9
3	CIS COLUMN	1754.5

Table No. 1: Dead Load

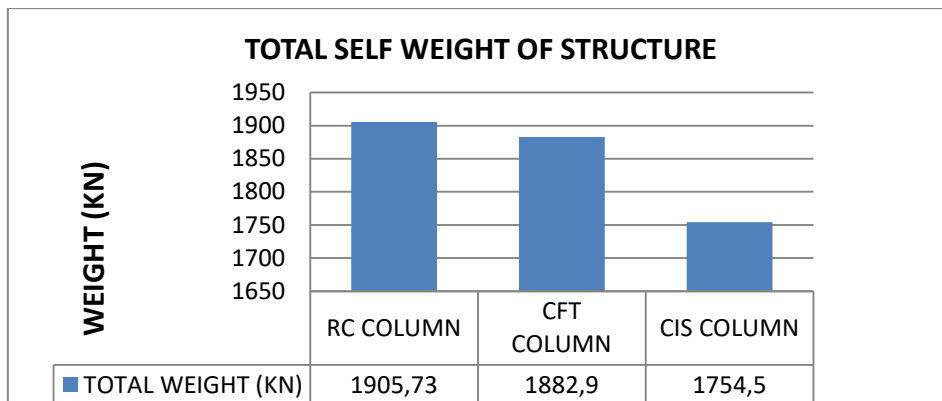

Graph No. 1

Base shear

As per cl. no. 4.7 in IS 1893-2002 Design Seismic Base Shear (V_B) is the total design lateral force at the base of a structure. The base shear in direction X & Y are describes as given below. The following table 3 & 4, graph shown in graph No. 2 & 3 gives variation in base shear of conventional & steel-concrete composite frame



Maximun Storey Shear in X-Direction

STORY LEVEL	Shear IN X-DIRECTION in KN		
	RCC	CFT	CIS
DOME TOP	0	0	0
WALL TOP	0.0022	0.0031	0.0133
TANK BOTTOM	0.0069	0.0105	0.0586
TIE 3	0.0075	0.0113	0.061
TIE 2	0.0079	0.0118	0.0626
TIE1	0.0082	0.0121	0.0635
PLINTH	0.0082	0.0121	0.0636
BASE	0	0	0

Table No. 2 Base Shear in X Direction

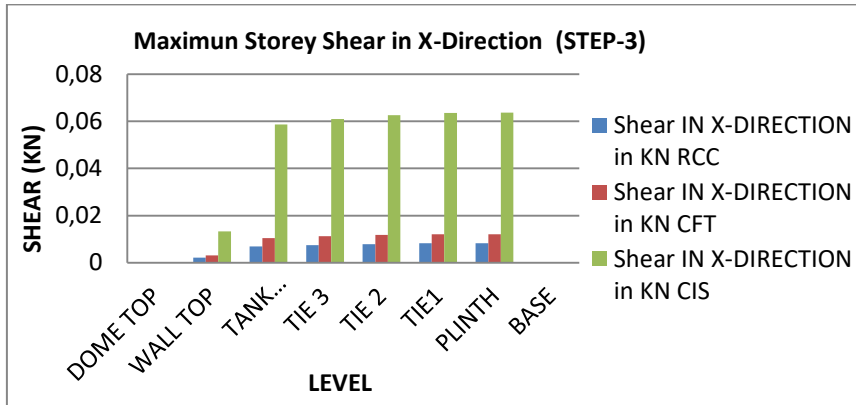

Graph No. 2

Variation in base shear in Y-direction

Maximun Storey Shear in Y-Direction

STORY LEVEL	Shear IN Y-DIRECTION in KN		
	RCC	CFT	CIS
DOME TOP	0	0	0
WALL TOP	-0.0057	-0.0085	0.0248
TANK BOTTOM	-0.0188	-0.0303	0.1062
TIE 3	-0.0204	-0.0324	0.1107
TIE 2	-0.0215	-0.0339	0.1139
TIE1	-0.022	-0.0346	0.1155
PLINTH	-0.0221	-0.0348	0.1157
BASE	0	0	0

Table No. 3 Base Shear in Y Direction

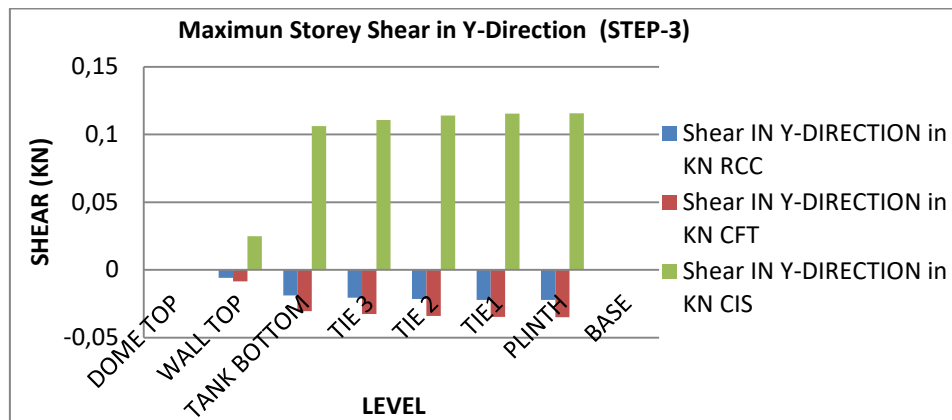

Graph No. 3

V. CONCLUSION

In elastic/pushover analysis of both RCC & Composite frame is carried out using ETAB. The outcome from the analysis is described with respective to various parameters in this chapter and comparative analysis is done with RCC frame. The result from above analysis shows that in case of dead load and Base Shear the sections of CFT give minimum dead load as compare to RCC. The base shear results of RCC are better than composite structure.

REFERENCES

1. Euro code 4, —design of composite steel and concrete structure,| european committee for standardization committee european de normalization europaises committee fur normung|.
2. Is: 456 (2000), “code of practice for plain and reinforced concrete”, bureau of indian standards, new delhi.
3. Is: 11384 (1985), “code of practice for composite construction in structural steel and concrete”, bureau of indian standards, new delhi
4. **Naveen Kumar S M, Kavana K. N, H. Eramma** “Analysis and design of Intze Water tank using Sap2000 Software” Journal of Structural technology e-ISSN: 2581 -950X Volume 4 Issue 3, 2019.
5. **Prashant A Bansode, V.P Datye** “Seismic Analysis of Elevated water tank with different staging Configuration” Journal of geotechnical Studies Volume 3 Issue 1, 2018
6. **Vyankatesh, More Varsha**, "Comparative Study on Dynamic Analysis of Elevated Water Tank Frame Staging and Concrete Shaft Supported ", OSR Journal of Mechanical and Civil Engineering (IOSR-JMCE), Volume 14, Issue 1 Ver. I, 2017.
7. **Ashish Vajir, Dattatray Jadhav, Ritesh K Jain**, "Analytical and Numerical Analysis of Composite Material Storage Tank under Seismic loading", SSRG International Journal of Mechanical Engineering, Volume 4, Issue 5, May 2017.
8. **N Beemkumar, Karthikeyan, Reddy**, "Analysis of Thermal Energy Storage Tank by ANSYS and Comparison with Experimental Results to Improve its Thermal Efficiency", Materials Science and Engineering, 197, 2017.
9. **Karthika J Prasad, 2Chinnu Sara Prasad**, "Seismic Analysis and Design ofStrengthening Techniques of Steel Storage Tank", International Journal of Advance Engineering and Research Development, Volume 4, Issue 5, May-2017



**Impact Factor:
7.569**



INTERNATIONAL JOURNAL OF INNOVATIVE RESEARCH

IN SCIENCE | ENGINEERING | TECHNOLOGY

 9940 572 462  6381 907 438  ijirset@gmail.com



www.ijirset.com

Scan to save the contact details