



e-ISSN: 2319-8753 | p-ISSN: 2320-6710

# IJIRSET

International Journal of Innovative Research in  
**SCIENCE | ENGINEERING | TECHNOLOGY**

# INTERNATIONAL JOURNAL OF INNOVATIVE RESEARCH

IN SCIENCE | ENGINEERING | TECHNOLOGY

Volume 10, Issue 2, February 2021

**ISSN** INTERNATIONAL  
STANDARD  
SERIAL  
NUMBER  
INDIA

**Impact Factor: 7.512**

9940 572 462

6381 907 438

[ijirset@gmail.com](mailto:ijirset@gmail.com)

[www.ijirset.com](http://www.ijirset.com)



# Implementation of Microgrid using (a) PV and (b) Wind with an Improved Transient in MATLAB Simulink

Shiv Kumar Shah <sup>1</sup>, Dr.P.K.Saha <sup>2</sup>

P.G., Department of Electrical Engineering, Jalpaiguri Govt. Engineering College, West Bengal, India<sup>1</sup>

Professor, Department of Electrical Engineering, Jalpaiguri Govt. Engineering College, West Bengal, India<sup>2</sup>

**ABSTRACT:** The paper present a system that convert a power generated from a renewable resources to a source having same voltage and frequency with respect to traditional power plant. As the conventional fossil fuel resources such as Coal, Diesel, Gas etc is limited in quantity which will run out very soon. Hence all the researchers throughout the world are looking for alternative form of energy[1]. As a consequence the penetration of WIND & PV – generated electrical energy into the grid system is increasing exponentially worldwide[2]. The paper consist of DFIG as wind generator, PV array, boost converter, 3phase VSC Inverter, synchronous generator and utility grid. PV system has low conversion efficiency, So to improve conversion efficiency it is important to work PV system always at its maximum power point. Maximum Power Point Tracker (MPPT) control technique is used to get maximum power as possible[3]. The voltage source inverter interface with grid and transfer an energy drawn from wind turbine and PV array to the grid by keeping the common voltage & frequency constant. The simulation results such as voltage, current, output power for each various combination have been recorded. The simulation has been accomplished in a Software of MATLAB Math Works.

**KEYWORDS:** PV Panel, Boost Converter, MPPT, P&O, DFIG, 3 Phase VSC.

## I. INTRODUCTION

In the last few years renewable energy have experienced one of the largest growth areas worldwide in percentage of over 30% per year, Compared with a growth of coal and lignite energy.

The goal of European community (the EU) is to reach 20% in 2020, but the the EU-27 energy is only 17% of world energy. The US, with 22% of energy share, has adopted similar goals under the pressure of public opinion concerned by environmental problems and in order to overcome the economical crisis. However, the policies of Asia and Pacific countries, with 35 % of energy share, will probably be more important in the future energy scenario. In fact countries like China and India require continuously more energy (China energy share has increased 1 point every year from 2000).

The need for more energy of the emerging countries and the environmental concerns of the US and the EU increases the importance of renewable energy sources in the future energy scenario.

## II. INTRODUCTION TO PV PANEL IN MICRO GRID

**SOLAR CELL :** A solar cell [4] or photovoltaic cell, is an electrical device that converts the energy of light directly into electricity by the photovoltaic effect, which is a [physical](#) and chemical phenomenon .

Solar cells are described as being photovoltaic, irrespective of whether the source is [sunlight](#) or an artificial light.

### Modelling of Solar Cell in Matlab

The terminal equation of current[5] & voltage of the PV - array is given by ,

$$I = N_p I_{PH} - N_p I_S [ \exp( q(V/N_s + I R_s/N_p) /KT_c A) - 1 ] - (N_p V / N_s + I R_s) / R_{SH}$$

The parameters along with the values used in modelling the PV Array are given

Symbol	Parameter	Value
$v$	solar cell output voltage	21.8
$I_{pH}$	Photocurrent	1.866
$I_s$	cell saturation current	$4.215e^{-48}$
$q$	electron charge	$1.6 \times 10^{-19} \text{ c}$
$k$	Boltzmann's constant	$1.38 \times 10^{-23} \text{ J/K}$
$T_C$	cell's working temperature	298 K
$A$	ideal factor	1.3
$R_{SH}$	shunt resistance	
$R_S$	series resistance	0.45
$I_{SC}$	cell's short-circuit current at a 25°C and 1kW/m <sup>2</sup>	3.11
$N_p$	number of solar cells in parallel	1
$N_s$	number of solar cells in series	36

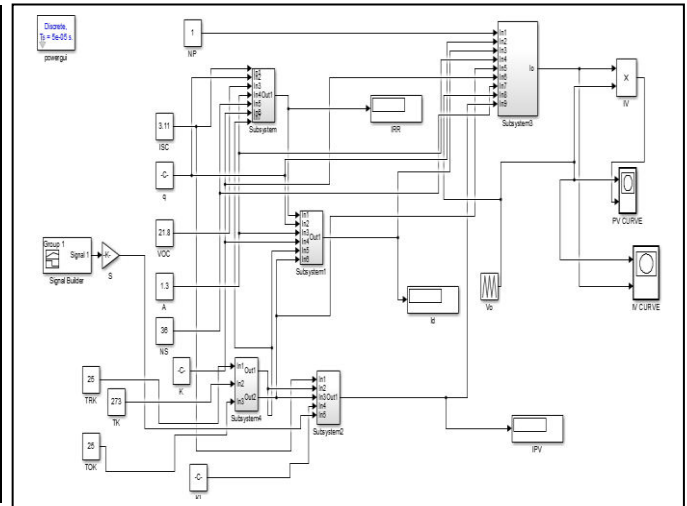

Fig1: Simulink model of PV panel with varying irradiance

If there is a change in environmental condition[6] than the solar irradiance also changes :

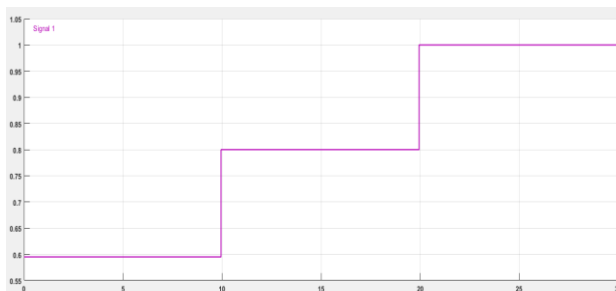

Fig 2: plot of irradiance with respect to time

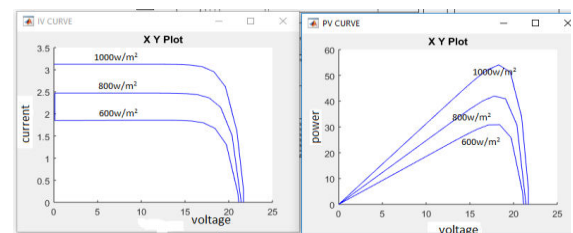

Fig 3: IV & PV Characteristics of PV array

### III.MAXIMUM POWER POINT TRACKING

The maximum power point tracking (MPPT) [7]method consider is to automatically find the current  $I_{MPP}$  or voltage  $V_{MPP}$  at which a PV array should work to extract the maximum output power  $P_{MPP}$  under a given temperature and irradiance. Most of MPPT methods respond to variations in both irradiance and temperature, but some are precisely more useful if temperature is approximately constant. There are different MPPT algorithms[8] [9] and among these techniques, the Incremental conductance algorithms and the P&O algorithms are generally used. In this project Incremental conductance method is used because of several advantage over the other such as :

- Incremental method can calculate the direction, for which the array's point changed in order to reach the MPP.

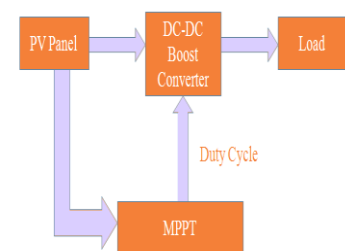

Fig 4: circuit arrangement for mppt



This method exploits the assumption of the ratio of change in Instantaneous conductance is equal to the negative of output Conductance ,

We have,  $P = V I$

Applying the chain rule for the derivative of products yields to

$$\partial P / \partial V = [\partial(VI)] / \partial V$$

At MPP, as  $\partial P / \partial V = 0$ ; Hence  $\partial I / \partial V = - I / V$

The MPPT regulates the PWM control signal of the dc – to – dc boost converter until the condition:

$(\partial I / \partial V) + (I / V) = 0$  is satisfied. In this method the peak the peak power of the module lies at above 98% of its incremental conductance

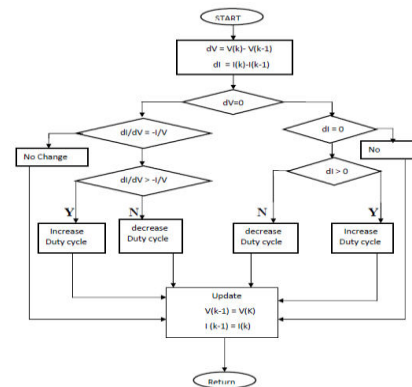

Fig 5 :Flow chart for Incremental Conductance

#### IV. BOOST CONVERTER

. A boost converter [10] is shown in Fig. 1. Only a switch is shown, for which a device belonging to transistor family is generally used. Also, a diode is used in series with the load. The inductance of the load is small. An inductance, L is assumed in series with the input supply.

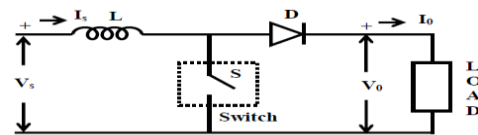

Fig 6 : Boost Converter

### Mode of operation

#### Operation of Boost Converter

##### Mode-1 (charging )

In this mode switch, S (i.e, the device) is turned ON during the period,  $T_{ON} \geq t \geq 0$ , the ON period being  $T_{ON}$ . The output voltage is zero ( $V_o = 0$ ), if no battery (back emf) is connected in series with the load, and also as stated earlier, the load inductance is small. The current from the source ( $I_s$ ) flows in the inductance L. The value of current increases linearly with time in this interval, with  $(di/dt)$  being positive. As the current through L increases, the polarity of the induced emf is taken as say, positive, the left hand side of L being +ve. The equation for the circuit is,

$$V_s = L \frac{di_s}{dt} \quad \text{or,} \quad \frac{di_s}{dt} = \frac{V_s}{L}$$

##### Mode – 2 (discharging) :

The switch, S is put OFF during the period,  $T \geq t \geq T_{ON}$ , the OFF period being  $T_{OFF} = T - T_{ON}$ . ( $T = T_{ON} + T_{OFF}$ ) is the time period. As the current through L decreases, with its direction being in the same direction as shown (same as in the earlier case), the induced emf reverses, the left hand side of L being -ve. So, the induced emf (taken as -ve in the equation given later) is added with the supply voltage, being of the same polarity, thus, keeping the current ( $I_o = I_s$ ) in the same direction. The current ( $I_s = I_o$ ) decreases linearly with time interval,  $T_{OFF}$ , as the output voltage is assumed to be nearly constant at  $V_o \approx V_{o_1}$  ( $di_s/dt$ ) being negative as  $V_s < V_o$ , which is derived as

The equation for the circuit is

$$V_s = V_o + L \frac{di_s}{dt} \quad \text{or,} \quad \frac{di_s}{dt} = \frac{V_s - V_o}{L}$$

From mode1 & mode2 the average value of the output voltage is

$$V_o = V_s \left( \frac{1}{1 - K} \right)$$

Where K is the duty ratio,  $k = \frac{T_{ON}}{T}$ ; ( with  $1 \geq k \geq 0$ )

Output voltage is always higher than the input voltage, So this is called boost converter.

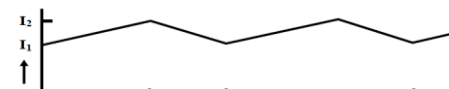

Fig 7 : Waveform of source current

The source current is assumed to be continuous.

**Mathematical Calculation**

From the mppt plot of input and output voltage for solar panel the value of duty ratio is

$$V_s = 273$$

$$V_o = 500$$

$$K = \frac{(V_o - V_s)}{V_o} = \frac{(500 - 273)}{500} = \frac{227}{500} = 0.454$$

**V. INVERTER**

A device that converts dc power into an ac power at a desired output voltage and frequency is called an [11] inverter. Some industrial application of inverter [12] are for adjustable-speed ac drives, induction heating, stand by air-craft power supplies, UPS for computer, HVDC transmission line etc.

The chapter provides an overview on neutral point clamped three level inverter (3-level bridge inverter[13] of selected force commutated power electronic device. Series RC snubber circuit are connected in parallel with each switch device, As capacitor (C<sub>s</sub>) in parallel with the device is sufficient to prevent unwanted (dv/dt) triggering of switches.

The inverter comprise of 3 arms for three phases.

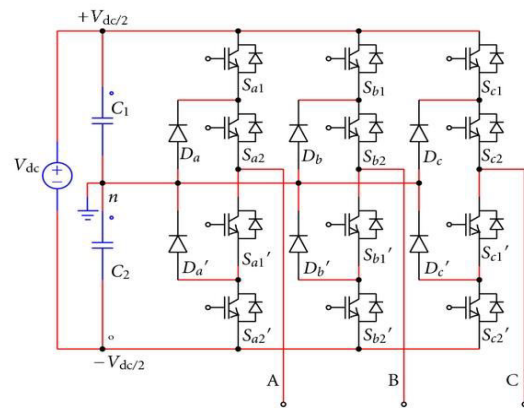

Fig 8: 3 level IGBT inverter

**Switching states**

Switching states that are shown in Table 1. can represents the operating status of the switches in the three-level NPC inverter. When switching state is '1', it is indicated that upper two switches in leg A connected and the inverter terminal voltage V<sub>An</sub> volts, which means the voltage for terminal A with respect to the neutral point n, is +E, whereas '-1' denotes that the lower two switches are on, which means V<sub>An</sub> volts = -E. When switching state '0', it indicates that the inner two switches S2 and S3 are connected and V<sub>An</sub> = 0v through the clamping diode, depending on the direction of the load current i<sub>A</sub>. When D<sub>n1</sub> is turn on, the load current will be positive (i<sub>A</sub>>0) and the terminal A will be connected to the neutral point 'n' through the conduction of D<sub>z1</sub> and S<sub>2</sub>. Table shows switching status for leg A. Leg B and leg C have the same concept.

Switching states	Device switching status (phase A)				Inverter Terminal Voltage (V <sub>Az</sub> )
	S <sub>1</sub>	S <sub>2</sub>	S <sub>3</sub>	S <sub>4</sub>	
1	ON	ON	OFF	OFF	E
0	OFF	ON	ON	OFF	0
-1	OFF	OFF	ON	ON	-E

Table 1: Definition of switching states

**Mathematical Calculation:**

The RMS value of line to line output voltage of 3 a level voltage source controller is given by :

$$V_{LL\_vsc} = (m * V_{dc} * 0.6124) \text{ volts}$$

Where,

$$M = \text{modulation index} = \frac{\text{peak value of carrier triangular wave (Vr)}}{\text{peak value of reference wave (Vc)}}$$

From the the MATLAB simulation

$$V_{dc} \text{ (input voltage to inverter)} = 500 \text{ v}$$

$$m = 0.84$$

$$\text{Than by the help of equation 1 ; } V_{LL\_vsc} = 0.82 * 500 * 0.6124 = 251.208 \text{ volts}$$

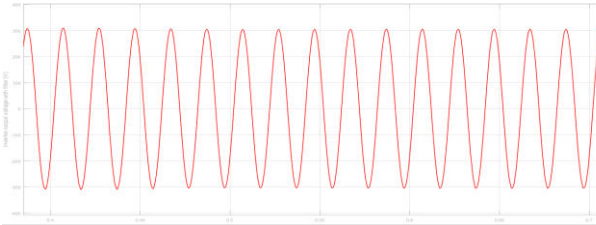

Fig9: Inverter output voltage with filter

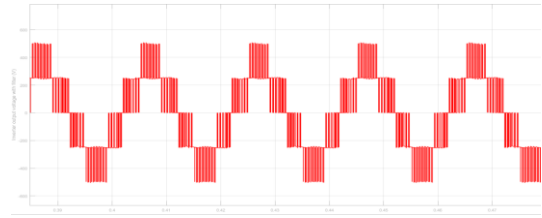

Fig10 : Inverter output voltage without filter

**VI. CONCEPT OF FILTER**

The use of inverter with output LC filter[14] allows for generation of out put sinusoidal voltage with low harmonic distortion, suitable for uninterruptible power supply system.

In this paper application of LC filter to a grid of (25 kv) fed by 3 level inverter of with switching frequency below 2000 Hz is described.

The PWM VSI offer at it terminal output voltage waveform which are closer to rectangular. This waveform causes several problem on the load (motor) and cable such as :

1. The 1<sup>st</sup> one is voltage spikes on the motor terminals caused by (dv/dt ) during switching transition .This (dv/dt) of the inverter output voltage causes reflection on the cable which may cause the motor terminal voltage to see double the voltage step. This phenomena depends on the cable length. The critical cable length for 500v/μsec is 100m range, for 1000v/μsec in the 50m range, for 10,000v/μsec in the 5m range.

**Filter Design :** To get sine waveform, the resonance frequency[15] of the filter has to be well below the lowest harmonic frequency of the inverter voltage resulting from PWM. The resonance frequency helps in calculating damping and stability. It can be found by the product of L and C

**2. Mathematical Calculation:**

3. If L = 1 mH

4. C = 100 μF

5.  $f_r = \frac{1}{\sqrt{(1 \times 10^{-3}) \times (100 \times 10^{-6})}} = 3162.27 \text{ Hz}$

$$f_r = \frac{1}{\sqrt{LC}}$$

**Harmonic analysis of inverter with filter**

THD Comparison :

No	Output Voltage (%THD ) Without Filter	Output Voltage (%THD ) With Filter
1	46.29	
2		0.46

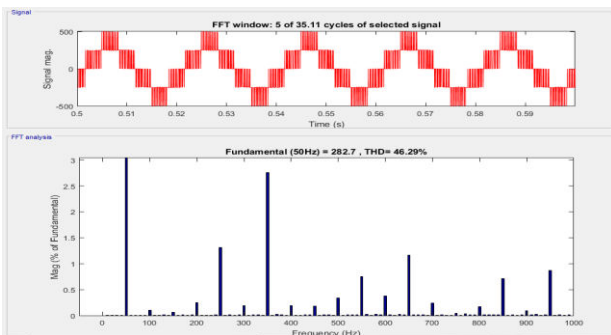

Fig11 : Plot of harmonic on output voltage without Filter

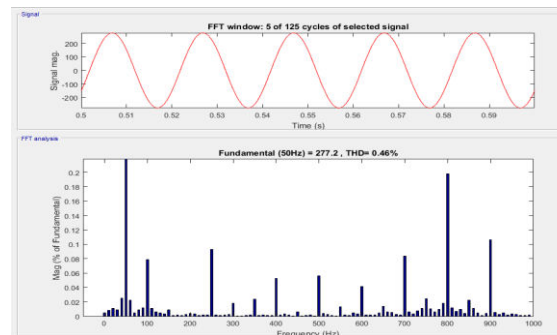

Fig12 : harmonic on output voltage with Filter

VII. CONTROL STRATEGY

A supply system with large no of synchronous machine connected in parallel is referred as grid. Any additional machine, whether to operate as source (generator, pv array, wind etc) or load (motor) is connected in parallel with bus bar.

The important requirement for a grid are

1. frequency should be same
2. phase angle should be constant and the
3. magnitude of voltage are not affected even if there is a variation excitation or power of a synchronous machine connected to it.

To meet the above condition a control system is needed.

Since solar energy ia always varying and dynamic in nature so MPPT controller extracts maximum power from PV panel, than on passing through Boost converter it acts as input to an inverter.This input is fed to the [16] Inverter control system which maintain the dc link voltage of the inverter constant. This dc link voltage [17] is treated as reference voltage for the PI controller of  $V_{DC}$  Regulator.

To control the grid voltage and current, Phase Lock Loop (PLL) and current regulator is used. In this control topology the sinusoid three phase measured value of voltage and current of a grid is first converted to stationary dqo frame of reference called park's transformation before feeding to PID controller

Park's Transformation ( abc to dqo)

Park's transformation uses frame of reference on the rotor. Robert H Park (1902-1994) derived this for a synchronous machine and so this is the same as a synchronous frame of reference. For an induction machine it is important to distinguish between a synchronous reference frame and a reference frame on the rotor. In the 3 phase system all the phases are  $120^\circ$  electrically spaced. For Park's the Transformation is in order :

$$abc \gg \alpha\beta \gg dqo$$

i.e. (a b c) is first transformed into 2 phase stationary frame ( $\alpha \beta$ ) than to (d q o) reference frame which rotates at synchronous speed.

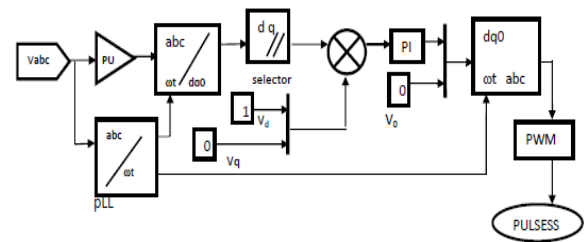

Fig13 : Control Topology of Voltage Control

$$\begin{bmatrix} i_a \\ i_b \\ i_c \end{bmatrix} = \begin{bmatrix} \cos \theta & \cos(\theta - 120) & \cos(\theta + 120) \\ \sin \theta & \sin(\theta - 120) & \sin(\theta + 120) \\ \frac{1}{2} & \frac{1}{2} & \frac{1}{2} \end{bmatrix} * \begin{bmatrix} i_d \\ i_q \\ i_o \end{bmatrix} \quad \& \quad \begin{bmatrix} i_d \\ i_q \\ i_o \end{bmatrix} = \begin{bmatrix} \cos \theta & \sin \theta & 1 \\ \cos(\theta - 120) & \sin(\theta - 120) & 1 \\ \cos(\theta + 120) & \sin(\theta + 120) & 1 \end{bmatrix} * \begin{bmatrix} i_a \\ i_b \\ i_c \end{bmatrix}$$

VIII. WIND TURBINE

As a result of increasing environmental concern, more and more electricity is generated from renewable sources to use wind turbine. Hence numbers of wind turbines are being erected[18]. It has started to influence the dynamics of electrical power systems by interacting with conventional generation equipment and with loads.

The steady state output power characteristics of the Turbine is given by following equation:

$$P_m = C_p (\lambda, \beta) \frac{\rho A}{2} v_{wind}^3$$

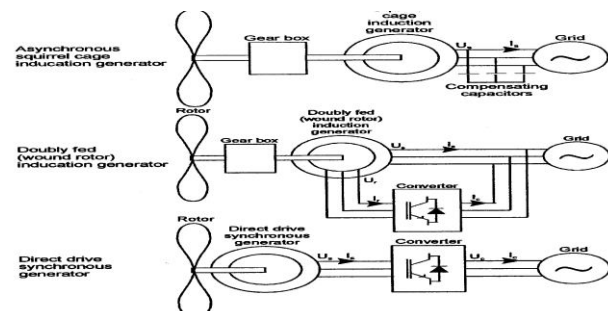

Fig 14 : Frequently occurring wind turbine type

The steady state output power characteristics of the Turbine is given by following equation:

$$P_m = C_p (\lambda, \beta) \frac{\rho A}{2} v_{wind}^3$$

Where,

$P_m$	Mechanical output power of the turbine (W)
$C_p$	Performance coefficient of the turbine
$\rho$	Air density ( $kg/m^3$ )
$A$	Turbine swept area ( $m^2$ )
$V_{wind}$	Wind speed (m/s)
$\lambda$	Tip speed ratio of rotor blade tip speed to $V_{wind}$
$\beta$	Blade pitch angle (deg)
$\theta$	Pitch angle of rotor
$\omega_w$	Turbine rotor speed

The performance coefficient of wind turbine is defined as the ratio of power output to the power contained

$$C_p = \frac{\text{Power output from the wind turbine}}{\text{power available in wind}}$$

Mechanical power transfer to the shaft is equal to

$$P_m = 0.5 \rho A C_p V_w^3$$

Where power coefficient ( $C_p$ ) is a function of pitch angle  $\beta$  and tip speed ratio  $\lambda$ . The characteristic curve show the detail behavior of mechanical power extract from the wind and the rotor speed at different wind speed and pitch angle ( $\beta$ )

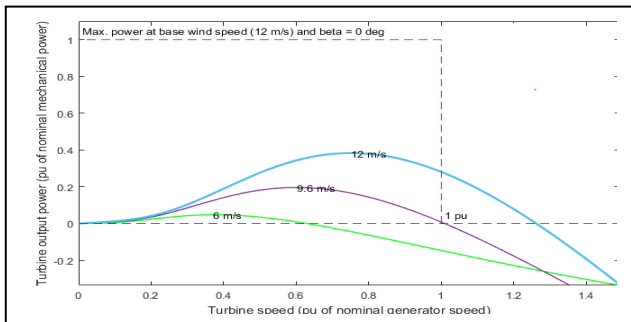

Fig 15: Wind Turbine power Curve ( $\beta = 15$  degree)

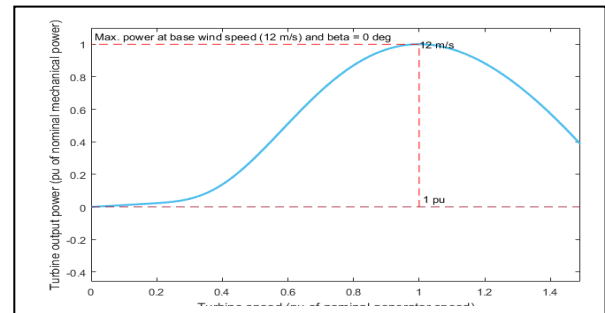

Fig 16: Wind Turbine Power Curve ( $\beta = 0$  degree)

### IX. SIMULATION AND RESULTS

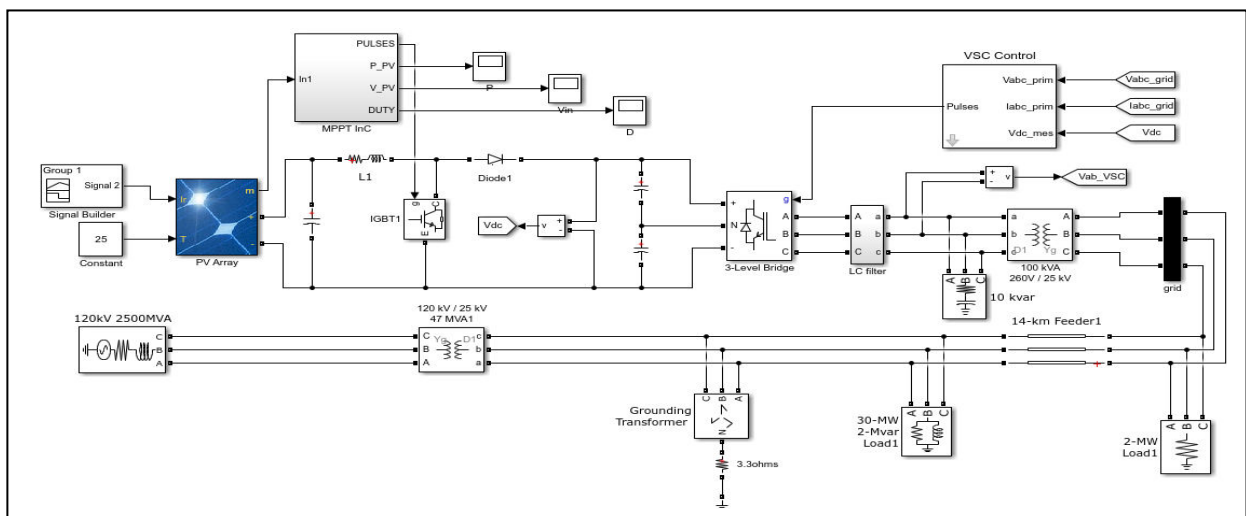

Fig17 : Simulink model of a 100 KW solar panel connected to a grid



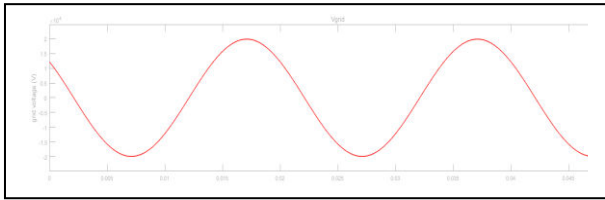

Fig18: grid voltage connected to PV

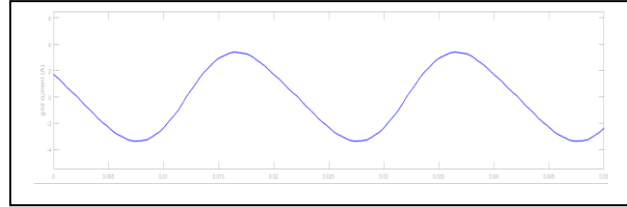

Fig 19: grid current supplied by PV Panel

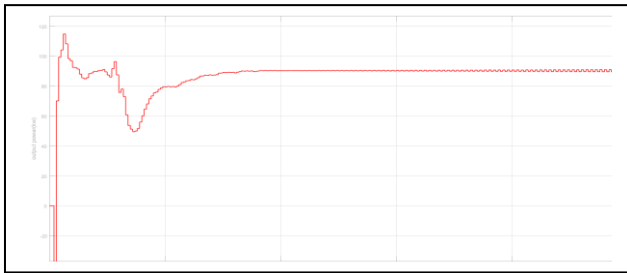

Fig 20: Inverter output power

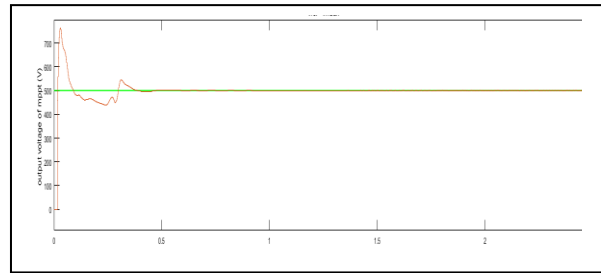

Fig 21: Boost Output Voltage

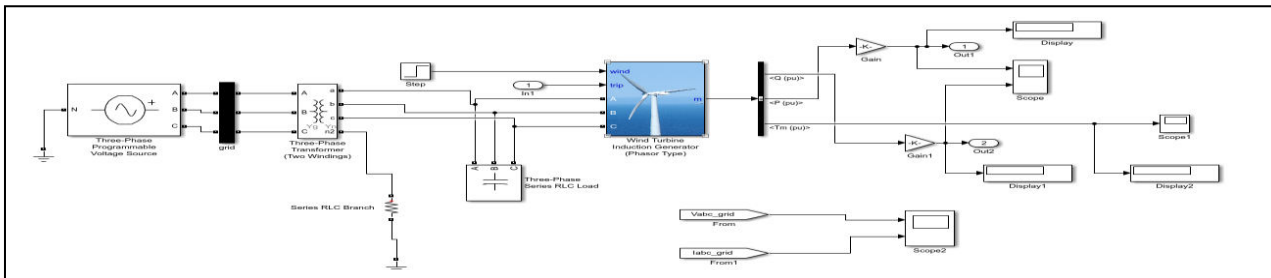

FIG 22: SIMULINK MODEL OF 1500 KW WIND TURBINE CONNECTED TO A GRID

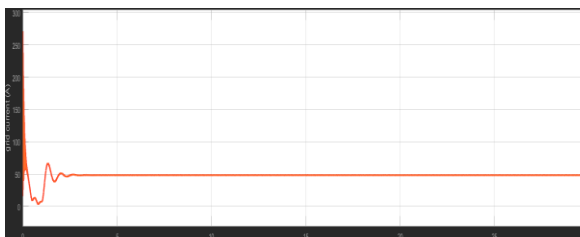

Fig 23: Wind Turbine Grid Current



Fig 24: Wind Turbine Grid Voltage



Fig 25 : Wind Turbine active power (W)

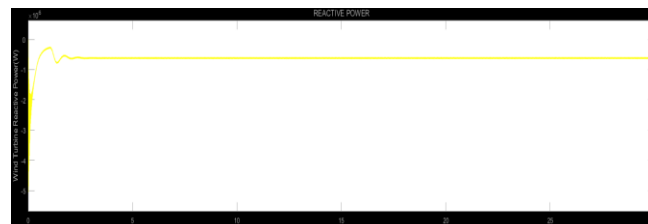

Fig 25 : Wind Turbine Reactive Power

X. CONCLUSION

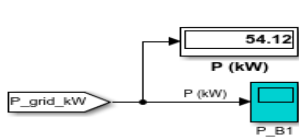

Fig26: Input power at 600 W/m<sup>2</sup>

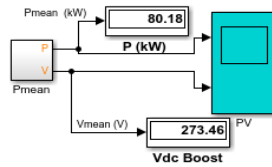

Fig27: Input power at 800 W/m<sup>2</sup>

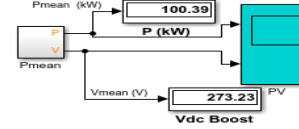

Fig28: Input power at 1000 W/m<sup>2</sup>

From the table we can say with the change in irradiance there is very small change in solar voltage and the duty ratio, Hence we can say that MPPT is working satisfactorily. For different Irradiance power supplied by Solar Panel only changes, the terminal voltage of solar panel is unaffected. So we are able to control the grid voltage irrespective of Irradiance.

S. No	Irradiances (Watt/metre <sup>2</sup> )	Solar Voltage (Volts)	DC Voltage (Volts)	Duty ratio	Solar Power (Kilo watt)
1.	600	272.25	500	0.455	59.88
2.	800	273.46	500	0.45308	80.18
3.	1000	273.23	500	0.45354	100.39

REFERENCES

- [1] C. Chen, K. Chen, and Y. Chen, "A Semi-Isolated Multi-Input Converter for Hybrid PV / Wind Power Charger System," pp. 3592–3597, 2014.
- [2] S. Bae and A. Kwasinski, "Dynamic modeling and operation strategy for a microgrid with wind and photovoltaic resources," *IEEE Trans. Smart Grid*, vol. 3, no. 4, pp. 1867–1876, 2012.
- [3] K. H. Hussein, "Maximum photovoltaic power tracking: an algorithm for rapidly changing atmospheric conditions," *IEE Proc. - Gener. Transm. Distrib.*, vol. 142, no. 1, p. 59, 1995.
- [4] G. Bhuvanewari and R. Annamalai, "Development of a solar cell model in MATLAB for PV based generation system," *Proc. - 2011 Annu. IEEE India Conf. Eng. Sustain. Solut. INDICON-2011*, 2011.
- [5] W. Xiao, W. G. Dunford, and A. Capel, "A novel modeling method for photovoltaic cells," *PESC Rec. - IEEE Annu. Power Electron. Spec. Conf.*, vol. 3, pp. 1950–1956, 2004.
- [6] K. Ding, X. Bian, H. Liu, and T. Peng, "A MATLAB-simulink-based PV module model and its application under conditions of nonuniform irradiance," *IEEE Trans. Energy Convers.*, vol. 27, no. 4, pp. 864–872, 2012.
- [7] J. H. R. Enslin, M. S. Wolf, D. B. Snyman, and W. Swiegers, "Integrated photovoltaic maximum power point tracking converter," *Ieee Trans. Ind. Electron.*, vol. 44, no. 6, pp. 769–773, 1997.
- [8] B. Subudhi and R. Pradhan, "A Comparative Study on Maximum Power Point Tracking Techniques for Photovoltaic Power Systems," *Sustain. Energy, IEEE Trans.*, vol. 4, no. 1, pp. 89–98, 2013.
- [9] D. Sera, L. Mathe, T. Kerekes, S. V. Spataru, and R. Teodorescu, "On the perturb-and-observe and incremental conductance mppt methods for PV systems," *IEEE J. Photovoltaics*, vol. 3, no. 3, pp. 1070–1078, 2013.
- [10] P. W. Lee, Y. S. Lee, D. K. W. Cheng, and X. C. Liu, "Steady-state analysis of an interleaved boost converter with coupled inductors," *IEEE Trans. Ind. Electron.*, vol. 47, no. 4, pp. 787–795, 2000.
- [11] B. K. Lee and M. Ehsani, "A simplified functional simulation model for three-phase voltage-source inverter using switching function concept," *IEEE Trans. Ind. Electron.*, vol. 48, no. 2, pp. 309–321, 2001.
- [12] T. Ohnishi, "Three phase PWM converter/inverter by means of instantaneous active and reactive power control," *Proc. IECON '91 1991 Int. Conf. Ind. Electron. Control Instrum.*, pp. 819–824, 1991.
- [13] A. Nabae, I. Takahashi, and H. Akagi, "A New Neutral-Point-Clamped PWM Inverter," *IEEE Trans. Ind. Appl.*, vol. IA-17, no. 5, pp. 518–523, 1981.
- [14] J. K. Steinke, "Use of an LC filter to achieve a motor-friendly performance of the PWM voltage source inverter," *IEEE Trans. Energy Convers.*, vol. 14, no. 3, pp. 649–654, 1999.
- [15] P. A. Dahono, "A control method to damp oscillation in the input LC filter," *2002 IEEE 33rd Annu. IEEE Power Electron. Spec. Conf. Proc. (Cat. No.02CH37289)*, vol. 4, pp. 1630–1635, 2002.
- [16] E. Pouresmaeil, D. Montesinos-Miracle, and O. Gomis-Bellmunt, "Control scheme of three-level NPC inverter



- for integration of renewable energy resources into AC grid,” *IEEE Syst. J.*, vol. 6, no. 2, pp. 242–253, 2012.
- [17] T. P. W. M. Inverters and M. Vujacic, “Analysis of dc-Link Voltage Switching Ripple in Three-phase PWM Inverter,” *MDPI Energy J.*, vol. 11, no. 5, pp. 6–14, 2018.
- [18] J. G. Sloopweg, H. Polinder, and W. L. Kling, “Dynamic modelling of a wind turbine with doubly fed induction generator,” *2001 Power Eng. Soc. Summer Meet. Conf. Proc. Cat No01CH37262*, vol. 1, pp. 644–649, 2001.

#### REFERENCES



**Shiv Kr. Shah** received B.Tech degree in Electrical & Electronics Engineering From West Bengal University of Technology, Kolkata , India in 2016, & Qualified GATE -16, Completed M.Tech through MHRD, India in Power Electronics From Jalpaiguri government engineering college, West Bengal, India, in 2018.



**INNO**  **SPACE**  
SJIF Scientific Journal Impact Factor

**Impact Factor:**  
**7.512**

**ISSN** INTERNATIONAL  
STANDARD  
SERIAL  
NUMBER  
**INDIA**



# INTERNATIONAL JOURNAL OF INNOVATIVE RESEARCH

IN SCIENCE | ENGINEERING | TECHNOLOGY

 **9940 572 462**  **6381 907 438**  **ijirset@gmail.com**



[www.ijirset.com](http://www.ijirset.com)

Scan to save the contact details