



e-ISSN: 2319-8753 | p-ISSN: 2320-6710

# IJRSET

International Journal of Innovative Research in  
**SCIENCE | ENGINEERING | TECHNOLOGY**

# INTERNATIONAL JOURNAL OF INNOVATIVE RESEARCH

IN SCIENCE | ENGINEERING | TECHNOLOGY

Volume 10, Issue 3, March 2021

**ISSN** INTERNATIONAL  
STANDARD  
SERIAL  
NUMBER  
INDIA

**Impact Factor: 7.512**

9940 572 462

6381 907 438

[ijirset@gmail.com](mailto:ijirset@gmail.com)

[www.ijirset.com](http://www.ijirset.com)

# Design and Analysis of Microstrip Antenna Array with Dual Notched and Defected Ground Structures for 5G C-Band Applications

Bhoopendra Kumar Rajak<sup>1</sup>, Prof. Nitesh Kumar<sup>2</sup>

M.Tech Scholar, Dept. of ECE., Sagar Institute of Research Technology & Science, Bhopal, India<sup>1</sup>

Assistant Professor, Dept. of ECE., Sagar Institute of Research Technology & Science, Bhopal, India<sup>2</sup>

**ABSTRACT:** The 5th generation mobile communication provides various advance application with high quality of services. The research is continuing going on 5G network communications applications. The expectation from 5G antenna is to meet the higher speed, low latency and large bandwidth. An antenna array is a set of multiple connected antennas which work together as a single antenna, to transmit or receive radio waves. Microstrip Patch Antenna (MPA) array design is also very emerging research area for 5th generation communication application. This paper proposed a novel design of microstrip antenna array with dual notched and defected ground structures for 5G C-band applications. The CST microwave studio software is used to antenna design and simulation. The resonant frequency of this antenna is 5.4GHz and 6.4GHz. Overall bandwidth achieved by proposed antenna is 3.06GHz. The large bandwidth is applicable for next generation or 5G communication mobile applications.

**KEYWORDS:** Notch, Microstrip, Array, Antenna, CST, FR4, VSWR, Return Loss, Bandwidth.

## I. INTRODUCTION

With the advancement of remote correspondence advances, it has gotten progressively alluring for present day specialized gadgets to coordinate different correspondence guidelines, for example, 2G/3G/4G/5G. Hence, radio wires with broadband execution are popular for multi-standard inclusion. Array receiving wires are generally utilized in remote correspondence frameworks. To accomplish broadband activity, different plans of array reception apparatuses have been accounted for, for example, altering the state of the array arms, improving taking care of strategies, stacking parasitic radiators, and utilizing magneto-electric reciprocal structures.[1]

Moreover, radiation execution is additionally required for some remote correspondence applications, for example, indoor sign inclusion, remote passages, and small scale base stations. In view of the multi-mode PFDA, a straightforward and powerful structure to accomplish radiation execution is created by setting two of the proposed PFDA's consecutive. The subsequent reception apparatus displays great radiation designs in the even plane with level increase variety of fewer than 1.27 dB. The introduced conservative broadband radio wire is a decent contender for indoor sign inclusion.

Three resounding modes are gotten by utilizing a changed planar collapsed array and its coupled taking care of structure. Consolidating the shorting pins and parasitic patches, numerous resounding modes in the receiving wire are controlled, moved, and afterward joined to build the impedance data transmission. Utilizing this idea, a model of a multimode collapsed array is planned, manufactured, and estimated [1]. Common coupling between two array receiving wires with various measurements put at self-assertive equal positions is broke down utilizing synchronous indispensable conditions with definite parts and limited hole feeds[2]. A tale plan technique for a wideband double enraptured reception apparatus is introduced by utilizing shorted dipoles, incorporated baluns, and crossed feed lines. Reenactment and proportionate circuit investigation of the receiving wire are given. To approve the plan technique, a receiving wire model is planned, upgraded, manufactured, and estimated [3]. This reflects array receiving wire comprises of a wideband feed and a wideband reflecting surface. The feed is a log-occasional array cluster reception apparatus. The reflecting surface comprises of  $26 \times 11$  unit cells. Every cell is made out of a firmly coupled array and a defer line. The base separation between nearby cells is 8 mm, which is around 1/10 frequency at the most minimal working recurrence. By joining the benefits of reflect array reception apparatuses and those of firmly coupled exhibit radio wires, the proposed TCDR receiving wire accomplishes ultra wide transfer speed with decreased unpredictability and creation cost[4].

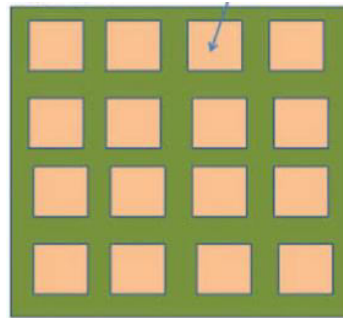

Figure 1: Array Antenna

Microstrip array radio wire is exceptionally well known in light of the fact that the data transmission of smaller scale strip array receiving wire is high when contrasted with the miniaturized scale strip fix reception apparatus. Small scale strip array reception apparatus will be the principle focal point of this work. A miniaturized scale strip array is a usage of the customary array radio wire on a dielectric chunk, which can be effortlessly created with existing PCB strategies. In contrast to regular small scale strip reception apparatus, that utilization one side of the chunk as the ground plane, the smaller scale strip array essentially utilizes the dielectric section as the host material. This receiving wire is picked in light of the fact that it is straightforward but then has potential for future improvement. A conservative wideband double spellbound receiving wire with improved upper out-of-band concealment is introduced in this work.

## II. BACKGROUND

**Y. Wang, et al.,[2019]** A novel design technique, which combines mushroom-shaped electromagnetic-band gap (EBG) structures and a slot together, is proposed for ultra-wideband (UWB) band-notched antenna. The implementation of the slot can not only create its own notched band, but also enhance the filtering performance at the other notched band generated by EBG structures. This is caused by the increased current density in the two ends of the slot. [1]

**T. Sun, et al.,[2019]** This work presents a compact miniaturized ultra-wideband(UWB) antenna with band-notched Function, which is experimentally researched for multiple-input-multiple-output (MIMO). Two selfsame monopoles are arranged symmetrically, which constitute the UWB-MIMO antenna. The monopole of the antenna is modified from a micro-strip off-center-fed patch.[2]

**M. Usman et al.,[2019]** In this work the design of a low profile flexible antenna for Ultra-Wideband (UWB) wireless communication systems along with the capability of rejecting interfering narrow-band Wi-MAX signal is presented. Polyimide based flexible, ultrathin and lightweight substrate is used to design the micro-strip antenna. An elliptical geometry is used as a radiating element along with a tapered Co-planar Waveguide (CPW) feeding technique to enhance the impedance bandwidth of the proposed antenna.[3]

**R. Dhara, et al.,[2018]** A compact tri-band circularly polarized (CP) micro strip patch antenna has been designed here where the antenna designed consists of a single G-shaped patch with CPW (Co-planar Waveguide) -fed ground. This configuration has been considered for bandwidth enhancement. Two semicircular-shaped notch has been etched from the lower periphery of CPW ground to increase the ARBW.[4]

**S. C. Deshmukh, et al.,[2018]** Printed modified hexagonal slot ultra-wideband micro strip-fed antenna with dual band rejection characteristics is presented. The antenna comprises U-shape radiating patch on one side of substrate and ground plane with modified hexagonal slot on other side of substrate with compact size of  $28 \times 28 \text{ mm}^2$ . By inserting symmetrical L-form parasitic ends at the upper edge at the modified hexagonal slot and C-shape parasitic stubs at the both arms of the patch to obtain the desired stop band characteristics for WiMAX and WLAN respectively. The designed antenna is operate in between 3.02~ 15GHz with a dual stop band from 3.15~4.06GHz (for Worldwide Interoperability for Microwave Access) and 5.13~6.2GHz (for Wireless Local Area Network). [5]

**K. Pattnaik, et al.,[2017]** In this work a new form of Ultra Wide Band (UWB) antenna with band rejection characteristic is proposed. The proposed antenna is the combination of a rectangular and a triangular patch with a half



ground plane with a slot in it. A complementary Split Ring Resonator (CSRR) which acts as an anisotropic filter structure is slotted along the feed of the antenna in order to achieve certain band notch characteristics. The antenna is designed on a 26.4 mm × 28.05 mm FR4 EPOXY substrate of thickness 1.5 mm. The antenna was observed to be operating from 3.1 to 10.1 GHz with a band notch from 5.3 to 5.8 GHz which envelopes the 5.5 GHz WLAN band. Also the effect of shifting the notch frequency band by changing the dimensions of the CSRR is discussed.[6]

**R. Mishra, et al.,[2017]** UWB is an emerging technology and has numerous applications in different fields in this digital era. As it is known that the range of UWB exist are 3.1GHz-10.6 GHz but some narrow band applications also exist in this range and causes interference to Ultra Wideband applications. In this proposed work a novel UWB antenna is integrated with W shape notch to reduce interference which mainly occurs at 5 GHz due to WLAN (IEEE 802.11a) and it also cover U-NII band (5.15-5.85 GHz). [7]

**H. S. Mewara, et al.,[2017]** Bandwidth enhancement of an ultra-wide band swastika slot loaded antenna with band notch characteristic is presented. The antenna consists of an exciting rectangular patch on the front side and a partial ground plane on the backside of the substrate. A swastika shape is etched on patch, by inserting corner slots to the swastika shape, notched frequency band is improved. The simulated impedance is defined by VSWR < 2 of 11.00 GHz operating over a frequency range 3.71-14.71 GHz with a single notched band of WLAN (5.27-6.22 GHz). Simulated Average gain of about 4 dBi is observed over the whole UWB band except at WLAN band notch.[8]

**G. Varshney et al.,[2016]** Here it is are presenting a simple Dielectric Resonator Antenna (DRA) fed by micro-strip patch with significant improvement in bandwidth and radiation characteristics for Wireless and radar applications. Simply a patch antenna is designed with triple band characteristics. To enhance the bandwidth, nearby resonant bands of antenna have been shifted close to each other and merged. [9]

**A. Das et al.,[2016]** A compact microstrip fed ultra-wideband(UWB) antenna with dual band notched characteristics is presented. The antenna comprises of an elliptical UWB patch antenna with partial arc shaped ground plane fed by micro-strip transmission line. Two open-ended quarter-wavelength straight slots are etched in the patch to generate the two notched band. The UWB antenna covers a wide impedance bandwidth ranges from 2.86GHz-14.9GHz with two band notched properties in the Wimax (3.1GHz-4.8GHz) X-band satellite link(9.6GHz-11.2GHz). [10]

III. PROPOSED METHODOLOGY

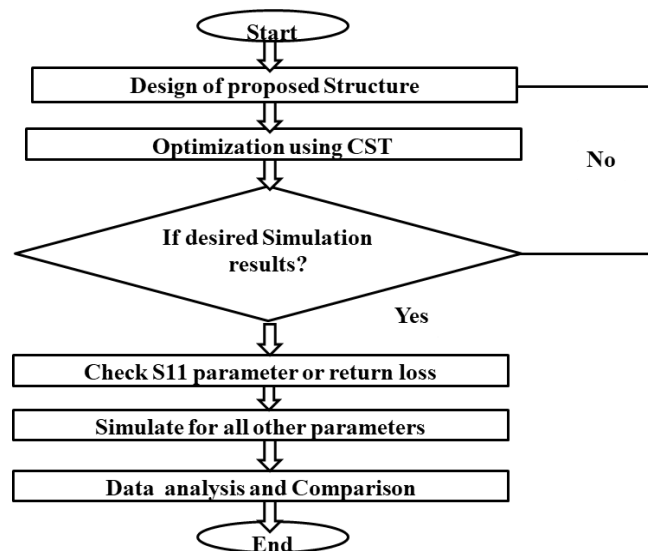

Figure 2: Flow Chart

The flow chart work as following steps-

1. First find application and define requirement.
2. Next steps is finding out major specification of antenna
  - a. Resonating Frequency of antenna (according to application define in initial step of CST).

3. Choose a suitable substrate, it may depend upon various factor like availability of material, integration of antenna with other circuit components on board. Dielectric constant and height of substrate are important for microstrip antenna parameter calculation.
4. Calculate Microstrip antenna dimension. Most of the time antenna used in wireless communication is not simple antenna, these are customized structure.
5. Calculate antenna width and length using standard formula.
6. Antenna height (Its define in substrate material already for microstrip antenna its usually 1.5mm-1.6 mm). It can be selected using CST
7. Draw antenna geometry and define materials.
8. Define feed-point and radiation boundary
9. Run simulation and check performance parameters values.

Firstly, identified the advance or upcoming application like antenna design for 5G communication application, it is identified through previous papers studied. Then find the technical specification. Now find out the appropriate model or design for desired application and outcomes. The next step is to set the target objective of research work. At last focus on the various challenges which occur during research and make the design strategy.

After the selection antenna band and application of design, the next step is to calculate the radiating patch width and length.

Step 1: Calculation of Width (W)

For an efficient radiator, practical width that leads to good radiation efficiencies is:

$$W = \frac{1}{2f_r \sqrt{\mu_0 \epsilon_0}} \sqrt{\frac{2}{\epsilon_r + 1}} \quad \text{Where, } \mu_0 \text{ is the free permeability, } \epsilon_0 \text{ is the free space permittivity and } \epsilon_r \text{ is relative permittivity.}$$

Step 2: Calculation of Effective Dielectric Coefficient ( $\epsilon_{r_{eff}}$ ) the effective dielectric constant is  $\epsilon_{r_{eff}} = \frac{\epsilon_r + 1}{2} + \frac{\epsilon_r - 1}{2} [1 + 12 \frac{h}{W}]^{-1/2}$

Step 3: Calculation of Effective Length ( $L_{eff}$ )

The effective length is 
$$L_{eff} = \frac{c}{2f_0 \sqrt{\epsilon_{r_{eff}}}}$$

Step 4: Calculation of Length Extension ( $\Delta L$ )

$$\frac{\Delta L}{h} = 0.412 \frac{(\epsilon_{r_{eff}} + 0.3) (\frac{W}{h} + 0.264)}{(\epsilon_{r_{eff}} - 0.258) (\frac{W}{h} + 0.8)}$$

Step 5: Calculation of actual Length of Patch (L)

The actual length of radiating patch is obtained by

$$L = L_{eff} - 2\Delta L$$

Step 6: Calculation of Ground Dimensions (Lg, Wg)

Now the use of CST microwave studio software, make the design using calculated dimensions.

Figure 3, showing top perspective on proposed microstrip array receiving wire, one side of a dielectric substrate goes about as an emanating array and opposite side of substrate goes about as ground plane. As in figure 3 demonstrated as follows, top perspectives on a rectangular array radio wire with microstrip feed has array and ground plane together makes bordering fields and this field is answerable for making the radiation from the receiving wire. Microstrip array reception apparatus is proposed because of little size and better reference. Resonant frequency of proposed reception apparatus is approx 5.4GHz and 6.4GHz that implies it work under C-band. Thusly proposed radio wire ought to be valuable for all C-band application.

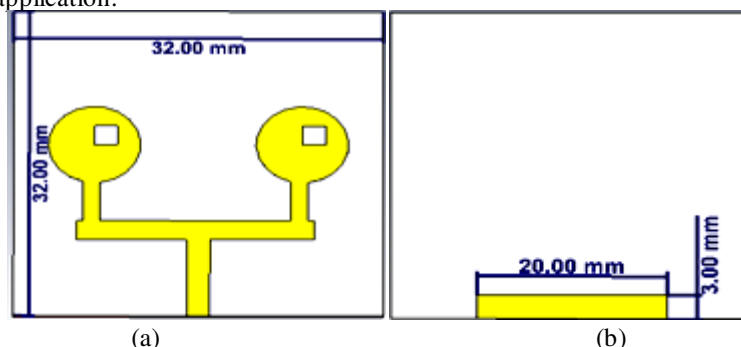

Figure 3: (a) Top view (b) Defected Ground Structure of proposed microstrip array antenna



Figure 3 is indicating proposed microstrip array antenna of plan. The top and ground layer is made by lossy copper material and substrate is made by FR4 material which having 4.4 dielectric steady worth.

IV. SIMULATION RESULTS

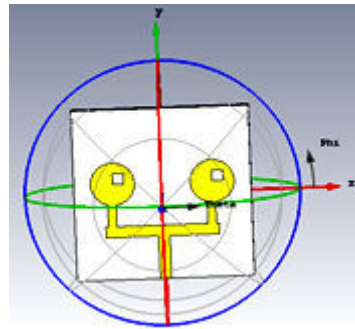

Figure 4: Simulation and fields of proposed antenna

CST microwave studio used to recreate the proposed plan. Figure 4 is demonstrating reenacted electric and attractive field in round organize framework.

Table 1: Design parameters for proposed Antenna

Sr No.	Parameter	Value
1	Lower Frequency( $f_L$ )	4 GHz
2	Higher Frequency( $f_H$ )	12 GHz
3	Dielectric constant( $\epsilon_r$ )	4.4 / FR4
4	Ground (LxW)	3 mm X 20 mm
5	Ground height	0.035mm
6	Substrate(LxW)	32mm X 32mm
7	Substrate Height(h)	1.57 mm
8	Line Impedance	50 $\Omega$
9	Tangent Loss	0.06
10	Input watt	0.5W

Band-I:  
Return loss

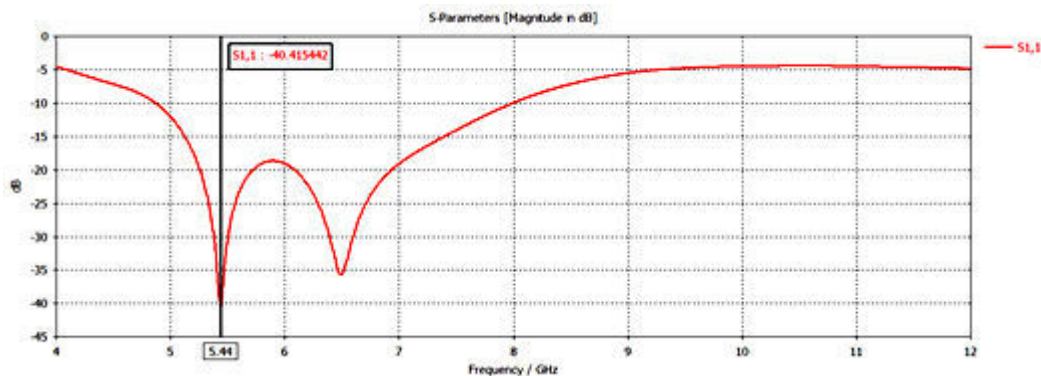

Figure 5: Return loss



Figure 5 presents return loss of proposed structure. It is obvious to see this chart, the return loss estimation of proposed antenna is -40.11 dB with 5.4GHz resonant frequency.

**Bandwidth**

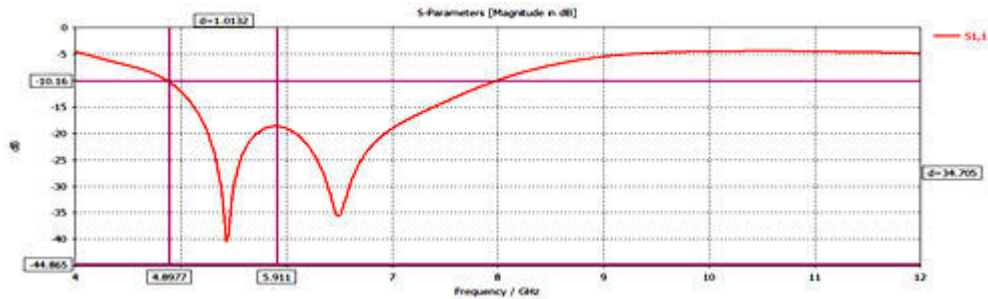

Figure 6: Bandwidth

For broadband antennas, the bandwidth is communicated as a level of the recurrence contrast (upper less lower) over the inside recurrence of the bandwidth. The bandwidth of proposed antenna is 1013MHz, (5.911GHz-4.897GHz), for first band.

**Voltage Standing Wave Ratio (VSWR)**

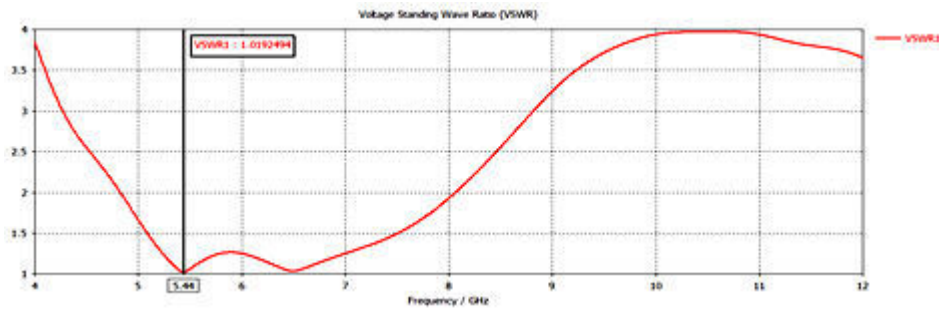

Figure 7: VSWR

Figure 7 shows VSWR esteem, it is voltage standing wave proportion, and is likewise alluded to as Standing Wave Proportion (SWR). VSWR is an element of the reflection coefficient, which portrays the force reflected from the antenna. The VSWR estimation of this antenna is 1.0192.

**Band-II:  
Return loss**

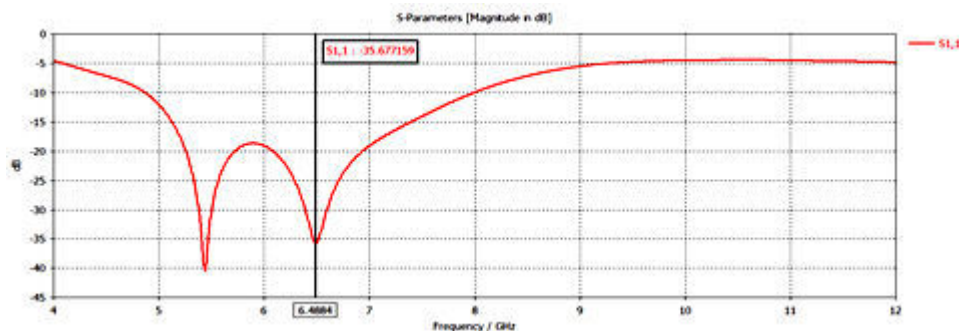

Figure 8: Return loss

Figure 8 presents return loss of proposed structure. It is obvious to see this chart, the return loss estimation of proposed antenna is -35.67dB with 6.4GHz thunderous recurrence.

**Bandwidth**

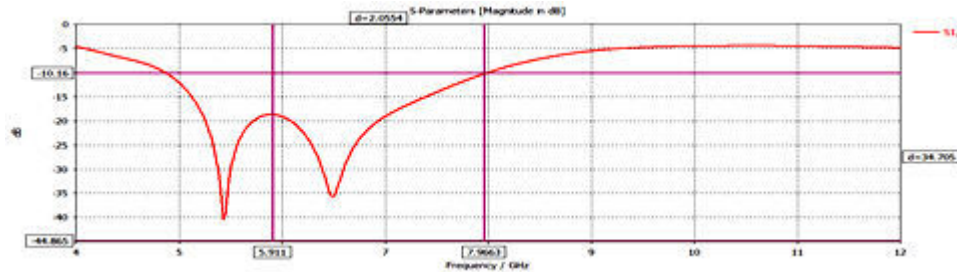

Figure 9: Bandwidth

The bandwidth of proposed antenna is 2055MHz, (7.966GHz-5.911GHz), for second band.

**Voltage Standing Wave Ratio (VSWR)**

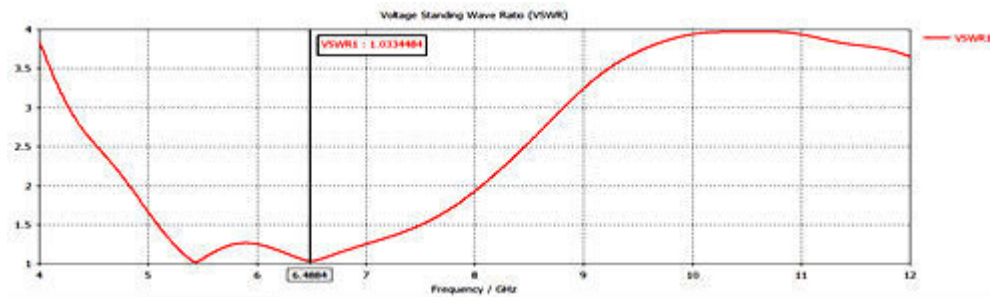

Figure 10: VSWR

Figure 10 shows VSWR esteem, it is voltage standing wave proportion, and is additionally alluded to as Standing Wave Proportion (SWR). VSWR is an element of the reflection coefficient, which portrays the force reflected from the antenna. The VSWR estimation of this antenna is 1.033.

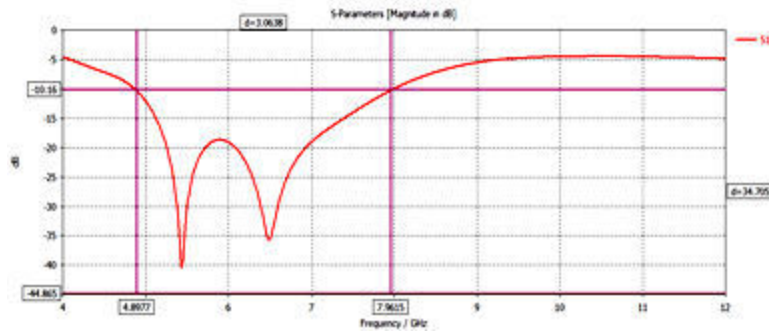

Figure 11: Bandwidth

The overall bandwidth of proposed antenna is 3063MHz, (7.96GHz-4.89GHz), for dual band.



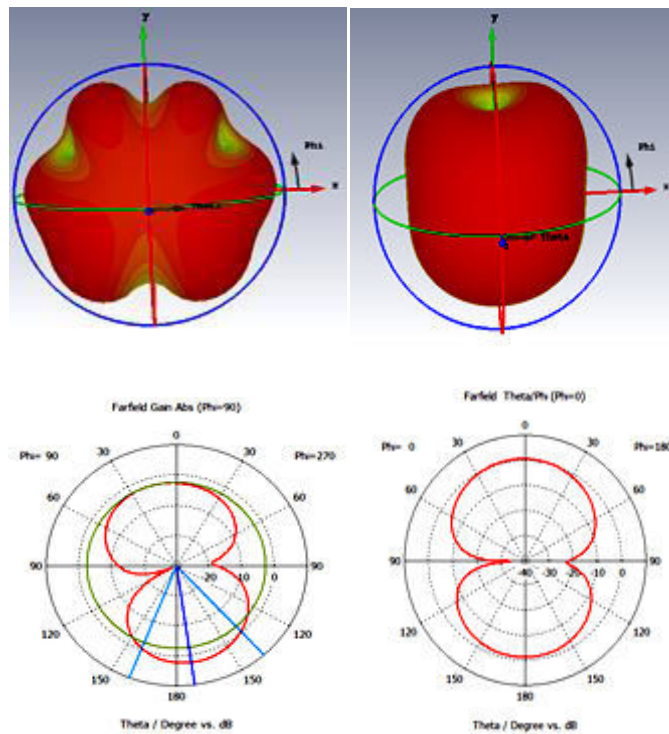

Figure 12: Radiation pattern

Figure 12 shows radiation pattern of proposed antenna at 5.4GHz and 6.4GHz band. It is a variety of the force transmitted by an antenna as an element of the heading ceaselessly from the antenna.

Table 2: Simulated Results of Proposed Antenna

Sr No.	Parameter	Band-I	Band-II
1	Return loss or S11	-40.41 dB	-35.67 dB
2	Bandwidth	1013MHz	2055MHz
3	VSWR	1.019	1.499
4	Resonant Frequency	5.44 GHz	6.48 GHz

Table 2 shows performance parameters like return loss, bandwidth, VSWR and resonating recurrence. It is clear by observing reenacted values from table 2, proposed antenna accomplish significant improved outcome.

Table 3: Comparison of proposed design result with previous design result

Sr No.	Parameter	Previous work	Proposed work
1	S11 or Return loss	-11dB and -18dB	-40.14 dB and -35.67
2	Band Width	50MHz and 200MHz	1013 MHz and 2055 MHz
3	VSWR	Aprox 1.031 and 1.132	1.019 and 1.499

4	Resonant Frequency	3.4 and 3.8 GHz	5.4 and 6.4 GHz
5	Number of band	2	2
6	Gain	Aprox 6dBi	8dBi
7	Design type	Array	Array
8	Dimension	80X51 mm <sup>2</sup>	32x32 mm <sup>2</sup>

Table 3 is showing comparison between previous design and proposed design. It is clear from this table and results the proposed antenna array design have significant good and improved result than previous results.

## V. CONCLUSION

A double band, microstrip array antenna with notched and DGS is planned and recreated utilizing CST microwave studio. The reproduction results are introduced and examined. Structure of proposed antenna is basic and reduced in size of 32 x32x1.6 mm<sup>3</sup>. Simulated results exhibit that the antenna bandwidth covers C-band, at full recurrence 5.4 GHz and 6.4 GHz for VSWR under 2, and S<sub>11</sub> -40.14 dB and -35.67dB. The bandwidth is huge accomplished better than micorstrip fix antenna structure. Micorstrio array antenna configuration is recently exploring theme among specialists. The general bandwidth is 3063MHz. Subsequently proposed antenna is reasonable and meets to current edge correspondence demands.

## REFERENCES

1. Y. Wang, T. Huang, D. Ma, P. Shen, J. Hu and W. Wu, "Ultra-wideband (UWB) Monopole Antenna with Dual Notched Bands by Combining Electromagnetic-Bandgap (EBG) and Slot Structures," *2019 IEEE MTT-S International Microwave Biomedical Conference (IMBioC)*, Nanjing, China, 2019, pp. 1-3.
2. T. Sun, J. Hong and J. Cheng, "A Compact Miniaturized UWB-MIMO Antenna With WLAN Band-Notched Function," *2019 International Conference on Microwave and Millimeter Wave Technology (ICMMT)*, Guangzhou, China, 2019, pp. 1-4.
3. M. Usman, A. Ali and A. U. Rehman, "Interference Mitigation using Slot cutting in UWB Antenna," *2019 2nd International Conference on Computing, Mathematics and Engineering Technologies (iCoMET)*, Sukkur, Pakistan, 2019, pp. 1-4.
4. R. Dhara, M. Sarkar, T. K. Dey and S. Kumar Jana, "A Tri-Band Circularly Polarized G- Shaped Patch Antenna for Wireless Communication Application," *2018 International Conference on Computing, Power and Communication Technologies (GUCON)*, Greater Noida, Uttar Pradesh, India, 2018, pp. 992-996.
5. S. C. Deshmukh, R. P. Labade and S. Sureshkumar, "Design of Modified Hexagonal UWB Slot Antenna with Dual Band Notched Characteristics," *2018 International Conference On Advances in Communication and Computing Technology (ICACCT)*, Sangamner, 2018, pp. 420-425.
6. K. Pattnaik, K. L. Sheeja, S. S. Panda and D. Mishra, "Compact UWB planar antenna with WLAN band rejection using complementary split resonator," *2017 International Conference on Wireless Communications, Signal Processing and Networking (WiSPNET)*, Chennai, 2017, pp. 982-985.
7. R. Mishra, R. Kalyan and Y. M. Dubey, "Miniaturized W slot ultra wide band microstrip antenna for short distance communication," *2017 International conference of Electronics, Communication and Aerospace Technology (ICECA)*, Coimbatore, 2017, pp. 332-336.
8. H. S. Mewara, R. Kumawat, M. M. Sharma and I. B. Sharma, "Bandwidth enhancement of ultra-wide band swastika slot loaded micro-strip antenna with band-notch characteristic," *2017 International Conference on Computer, Communications and Electronics (Comptelix)*, Jaipur, 2017, pp. 248-253.
9. G. Varshney, P. Mittal, V. S. Pandey, R. S. Yaduvanshi and S. Pundir, "Enhanced bandwidth high gain micro-strip patch feed dielectric resonator antenna," *2016 International Conference on Computing, Communication and Automation (ICCCA)*, Noida, 2016, pp. 1479-1483.
10. A. Das, S. Pahadsingh and S. Sahu, "Compact microstrip fed UWB antenna with dual band notch characteristics," *2016 International Conference on Communication and Signal Processing (ICCSP)*, Melmaruvathur, 2016, pp. 0751-0754.



11. I. Tabakh, K. Allabouche, M. Jorio, N. El Amrani El Idrissi and T. Mazri, "Design and simulation of a new dual-band microstrip patch antenna for UHF and microwave RFID applications," *2015 Third International Workshop on RFID And Adaptive Wireless Sensor Networks (RAWSN)*, Agadir, 2015, pp. 33-37.
12. C. N. Alvarez, R. Cheungy and J. S. Thompson, "Graphene reconfigurable antennas for LTE and WIFI Systems," *2014 Loughborough Antennas and Propagation Conference (LAPC)*, Loughborough, 2014, pp. 434-438.
13. T. Naeem, F. A. Tahir and A. I. Najam, "UWB Antenna with Notches at WLAN Bands," *2013 11th International Conference on Frontiers of Information Technology*, Islamabad, 2013, pp. 172-176.
14. S. Koley and S. Choudhury, "An Integrated Planar Bluetooth and UWB Monopole Antenna with Dual Notched Bands Based on Etched Slot on the Patch and Split Ring Resonators on the Ground Plane," *2013 Third International Conference on Advanced Computing and Communication Technologies (ACCT)*, Rohtak, 2013, pp. 142-145.
15. K. Vyas, A. K. Sharma and P. K. Singhal, "A Novel CPW Fed Multiband Circular Microstrip Patch Antenna for Wireless Applications," *2012 Fourth International Conference on Computational Intelligence and Communication Networks*, Mathura, 2012, pp. 1-4.



**INNO**  **SPACE**  
SJIF Scientific Journal Impact Factor

**Impact Factor:  
7.512**

**ISSN** INTERNATIONAL  
STANDARD  
SERIAL  
NUMBER  
**INDIA**



# INTERNATIONAL JOURNAL OF INNOVATIVE RESEARCH

IN SCIENCE | ENGINEERING | TECHNOLOGY

 **9940 572 462**  **6381 907 438**  **ijirset@gmail.com**



[www.ijirset.com](http://www.ijirset.com)

Scan to save the contact details