



e-ISSN: 2319-8753 | p-ISSN: 2320-6710

IJRSET

International Journal of Innovative Research in
SCIENCE | ENGINEERING | TECHNOLOGY

INTERNATIONAL JOURNAL OF INNOVATIVE RESEARCH

IN SCIENCE | ENGINEERING | TECHNOLOGY

Volume 10, Issue 3, March 2021

ISSN INTERNATIONAL
STANDARD
SERIAL
NUMBER
INDIA

Impact Factor: 7.512

9940 572 462

6381 907 438

ijirset@gmail.com

www.ijirset.com



High PSNR for Medical Image Fusion based on Hybrid NSCT and Neural Network

Dipika Kumari¹, Prof. Abhishek Agwekar²

M. Tech. Scholar, Dept. of Electronics and Communication Engineering, T.I.E.I.T, Bhopal, India¹,

Head of Dept, Dept. of Electronics and Communication Engineering, T.I.E.I.T, Bhopal, India²

ABSTRACT: This research work proposes an improved fusion technique for medical images using Non-subsampled Contourlet Transform (NSCT) and Neural Network (NN). The proposed approach is based on two processes, namely, image enhancement and image fusion to obtain more information on the fused image. The construction proposed in this paper is based on a non-subsampled pyramid structure and non-subsampled directional filter banks. The result is a flexible multiscale, multi-direction, and shiftinvariant image decomposition that can be efficiently implemented via the à trous algorithm. At the core of the proposed scheme is the non-separable two-channel non-subsampled filter bank (NSFB). The low resolution Positron Emission Tomography (PET) image is enhanced using Lagrange interpolation technique and then combined with the Magnetic Resonance Image (MRI) using proposed image fusion. By adopting the proposed interpolation the edge preservation is achieved, the spectral and spatial qualities are improved. Experimental results show that the application of proposed fusion has higher Peak Signal to Noise Ratio (PSNR) values with good visual perception. Comparing with other fusion methods, the proposed method has higher average gradient lower discrepancy and less Mean Square Error (MSE). Therefore the method proposed exhibits better image quality and proved to be advantageous.

KEYWORDS: Non-subsampled Contourlet Transform (NSCT), Neural Network (NN), PSNR, MSE

I. INTRODUCTION

The idea of picture combination has been generally utilized in numerous applications like medication, machine vision, programmed change identification, biometrics and so on. Medicinal picture combination is one of the cutting edge and precise demonstrative methods in restorative field. Imaging in medicinal field help the specialists to see the inside segments of the body for simple determination and make keyhole medical procedures for achieving the inside parts without truly opening a lot of bit of the body [1]. The pictures that are taken care of through picture preparing contain assortment of issues, for example, low goals, abnormal state of clamor, low differentiation, geometric twisting, nearness of imaging ancient rarities, reproduction and so forth. While dealing with the picture, these issues make the picture blemished for exact determination of sickness.

Another important feature of a transform is its stability with respect to shifts of the input signal. The importance of the shiftinvariance property in imaging applications dates back at least to Daugman and was also advocated. An example that illustrates the importance of shiftinvariance is image denoising by thresholding where the lack of shift-invariance causes pseudo-Gibbs phenomena around singularities [2]. Thus, most state-of-the-art wavelet denoising algorithms (see for example [3]) use an expansion with less shift sensitivity than the standard maximally decimated wavelet decomposition—the most common being the non-subsampled wavelet transform (NSWT) computed with the à trous algorithm [4]. In addition to shift-invariance, it has been recognized that an efficient image representation has to account for the geometrical structure pervasive in natural scenes [5]. In this direction, several representation schemes have recently been proposed. The contourlet transform is a multidirectional and multiscale transform that is constructed by combining the Laplacian pyramid [6], [7] with the directional filter bank (DFB) proposed in. The pyramidal filter bank structure of the contourlet transform has very little redundancy, which is important for compression applications. However, designing good filters for the contourlet transform is a difficult task. In addition, due to downsamplers and upsamplers present in both the Laplacian pyramid and the DFB, the contourlet transform is not shift-invariant.

There are various circumstances that require high spatial and high phantom goals at the same time in a solitary picture. In any case, as a rule, instruments are not ready to give such information either by structure or by observational requirements. For exact determination, radiologists must incorporate data from various pictures of a patient. Picture preparing is one sort of flag handling for this picture goes about as information, it might be either photograph or video

outline and the result of picture handling might be either a picture or a lot of qualities identified with the picture. The majority of the picture handling methods, picture of two-dimensional flag is treated as info and standard flag preparing strategies are connected to it. Picture and video pressure is a functioning application zone in picture preparing. In the field of Image handling, picture combination has gotten a huge consideration for remote detecting, therapeutic imaging, machine vision and the military applications. A various leveled thought of picture combination has been proposed for joining critical data from a few pictures into one picture.

The point of picture combination is to accomplish improved circumstance evaluation as well as increasingly quick and exact fulfillment of a pre-characterized assignment than would be conceivable utilizing any of the sensors independently. Principally picture combination requires exact methods and furthermore great comprehension of information. The last yield of picture combination is hoping to give more data than any of the single pictures by diminishing the MSE.

II. METHODOLOGY

Image Fusion

A combination strategy, which can join reciprocal directional data of a various picture into a solitary super picture, improves the data thickness. Using the excellence of wavelet changes that is multi band disintegration, best view can be chosen in some random band. The combination results show improved in general complexity.

Picture combination is the procedure that joins data from various pictures of a similar scene. These pictures might be caught from various sensors, obtained at various occasions, or having diverse spatial and ghastrly qualities. The object of the picture combination is to hold the most attractive qualities of each picture. With the accessibility of multi sensor information in numerous fields, picture combination has been accepting expanding consideration in the looks into for a wide range of utilizations.

Non-subsampled Contourlet Transform (NSCT):-

Fig. 1(a) displays an overview of the proposed NSCT. The structure consists in a bank of filters that splits the 2-D frequency plane in the sub-bands illustrated in Fig. 1(b). Our proposed transform can thus be divided into two shift-invariant parts: 1) a non-subsampled pyramid structure that ensures the multiscale property and 2) a non-subsampled DFB structure that gives directionality. 1) Non-subsampled Pyramid (NSP): The multiscale property of the NSCT is obtained from a shift-invariant filtering structure that achieves a sub-band decomposition similar to that of the Laplacian pyramid. This is achieved by using two-channel non-subsampled 2-D filter banks. Fig. 2 illustrates the proposed non-subsampled pyramid (NSP) decomposition with $J=3$ stages. Such expansion is conceptually similar to the one-dimensional (1-D) NSWT computed with the à trous algorithm [9] and has $J+1$ redundancy, where J denotes the number of decomposition stages. The ideal passband support of the low-pass filter at the J^{th} stage is the region.

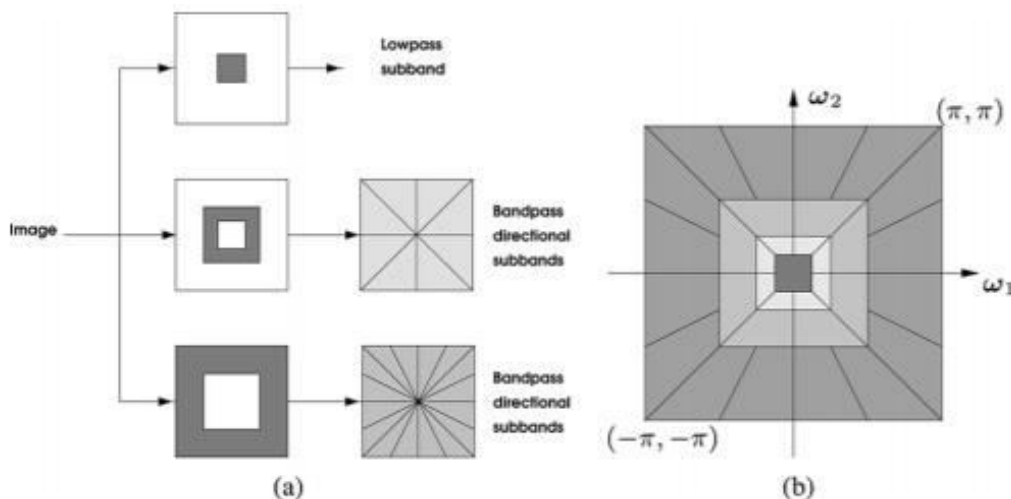

Fig. 1: Nonsubsampled contourlet transform. (a) NSFB structure that implements the NSCT. (b) Idealized frequency partitioning obtained with the proposed structure.

Neural Network (NN):-

A significant wellspring of difficulty in some genuine world artificial insight applications is that huge numbers of the components of variety influence each and every bit of information we can watch. The individual pixels in a picture of a red vehicle may be near dark around evening time. The state of the vehicle's outline relies upon the survey edge. Most applications expect us to unravel the variables of variety and dispose of the ones that we couldn't care less about.

Obviously, it very well may be very difficult to concentrate such elevated level, dynamic highlights from crude information. A large number of these elements of variety, for example, a speaker's articulation, can be identified just utilizing refined, about human-level comprehension of the information. At the point when it is so difficult to acquire a portrayal as to take care of the first issue, portrayal learning doesn't, at first look, appear to support us.

Profound learning takes care of this focal issue in portrayal learning by introduction ducing portrayals that are communicated as far as other, less complex portrayals.

Profound learning empowers the PC to assemble complex ideas out of more straightforward ideas. Figure 1.2 shows how a profound learning framework can speak to the idea of a picture of an individual by consolidating less complex ideas, for example, corners and forms, which are thus defined regarding edges.

The quintessential case of a profound learning model is the feedforward profound system, or multilayer perceptron (MLP). A multilayer perceptron is only a numerical capacity mapping some arrangement of info esteems to yield esteems. The capacity is shaped by making numerous less complex capacities. We can think about every use of a different numerical capacity as giving another portrayal of the information.

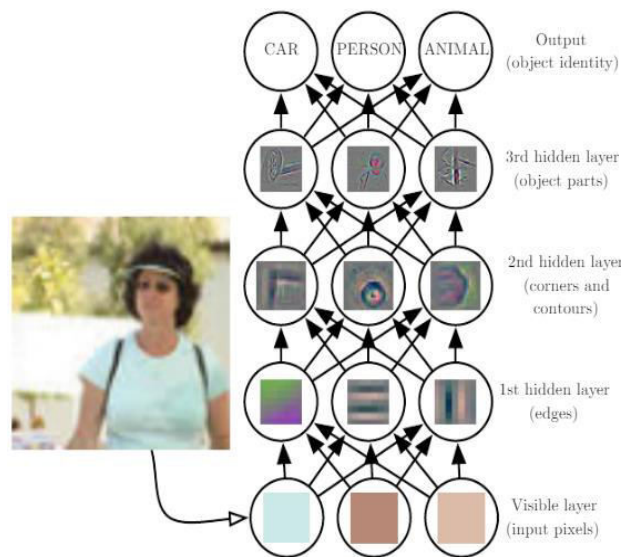

Fig. 2: Neural Network

III. PROPOSED METHODOLOGY

The prerequisite for the fruitful picture combination is that pictures must be accurately adjusted on a pixel-by-pixel premise. In this venture, the pictures to be consolidated are thought to be as of now superbly enlisted. The Fig. 3 demonstrates the best dimension square graph of picture combination utilizing wavelet change. The two info pictures picture 1 and picture 2 that are caught from noticeable and infrared camera separately are taken as data sources.

Low—frequency subband and high-frequency subbands can be obtained by NSCT transform. We can find that focus detection result in spatial domain is better than low-frequency subband. High-frequency subbands contain the salient feature of image and are applied to obtain the focus detection result in NSCT domain as a result. Usually, salient features of multi-focus images correspond to larger absolute value of high-frequency sub-bands coefficients. Therefore, the most popular fusion rule is to select the coefficients with larger absolute values. The shortcoming of this rule is obvious in that it does not take any consideration of the surrounding pixels. In recent years, PCNN is proved to be effective in the fusion of high-frequency subbands and utilized frequently.

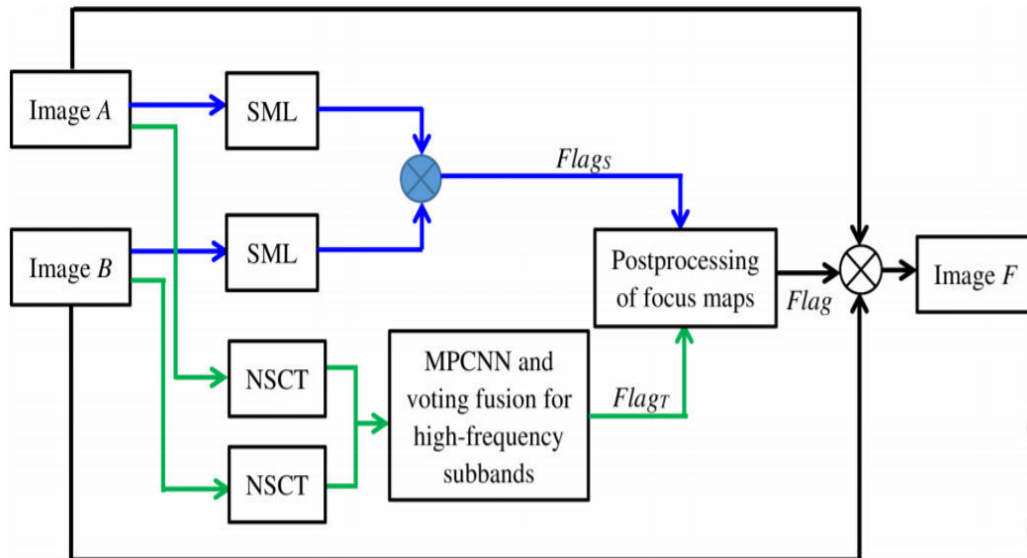

Figure- 3: Block diagram of Proposed Methodology

We have seen how to learn from data to solve supervised learning problem in previous section. In the informational collection it is critical to deactivate fields (characteristics, includes) that are generally enlightening. This is regularly proposed by a fare, yet when one isn't accessible the "animal power" technique for estimating everything accessible is applied. This shows the chance of getting the right (useful, significant) highlights segregated [1]. The basic advance of picking a particular learning calculation relies upon the second step of information extent and pre-preparing. At that point we can characterize preparing set from the assortment of dataset.

IV. SIMULATION RESULT

The proposed strategy for picture combination for tumor discovery is executed and recreated utilizing MATLAB. The low goals PET picture is upgraded by Lagrange insertion system to improve the goals. This exploration manages the Detection of Brain Tumor utilizing NSCT and NN based Medical Image Fusion for the analysis and better treatment. Picture Fusion is the way toward incorporating at least two pictures from a solitary methodology or various modalities. In this work, NSCT and NN based picture upgrade and combination system has been actualized and reproduced utilizing MATLAB. The proposed picture combination strategy comprises of two noteworthy procedures, for example, (I) picture improvement and (ii) picture combination both rely upon wavelet change. Lagrange interjection is utilized for picture improvement. X-ray and PET pictures are intertwined by the proposed technique.

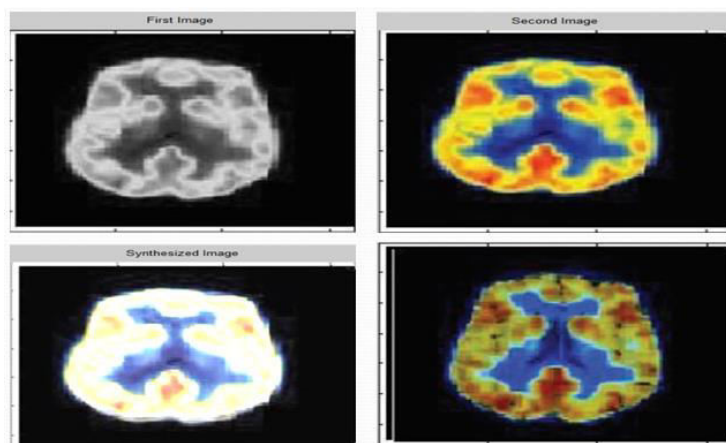

Figure 4: Fused image of MRI and PET normal Image



The combined picture has extra data from both MRI and PET pictures and the visual quality has improved. The combination parameters' Average Gradient, Discrepancy, PSNR, MSE and Entropy are determined and the outcomes demonstrate the viability of combination dependent on NSCT and NN. This work can be reached out to recognize any sort of irregularities in every single human organ like lungs, cervix, and kidney, etc.

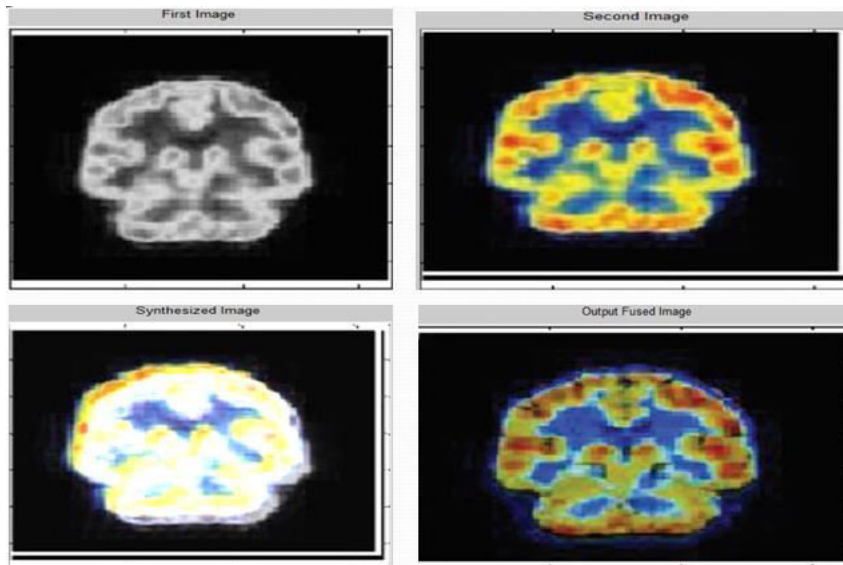

Figure 5: Fused image of MRI and PET normal Coronal images

Table 1: Performance Measure Based on Mean Square Error of The Output Fused Image

S. No.	Method	Database-I	Database-II	Database-III	Average
1	DWT	0.0190	0.0183	0.0192	0.01883
2	CT	0.0213	0.0198	0.0212	0.0207
3.	Hybrid	0.0072	0.0171	0.0047	0.0096
					0.0163

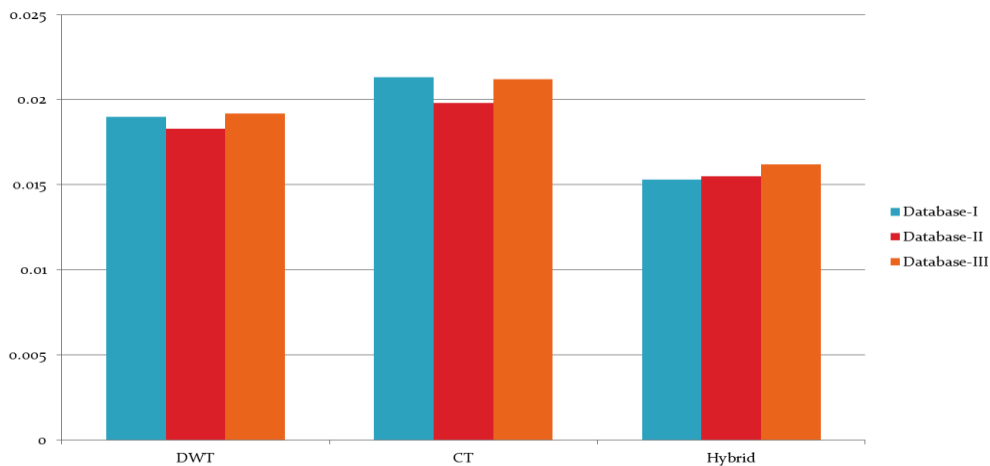

Figure 6: Bar Graph of the MSE for different technique

Table 2: Performance Measure Based on Peak Signal to Noise Ratio of The Output Fused Image



S.No.	Method	Database-I	Database-II	Database-III	Average
1	DWT	64.783 dB	63.983 dB	74.993 dB	67.919
2	CT	73.662 dB	68.962 dB	82.602 dB	75.075
3.	Hybrid	82.442 dB	73.859 dB	90.075 dB	82.125
					75.039

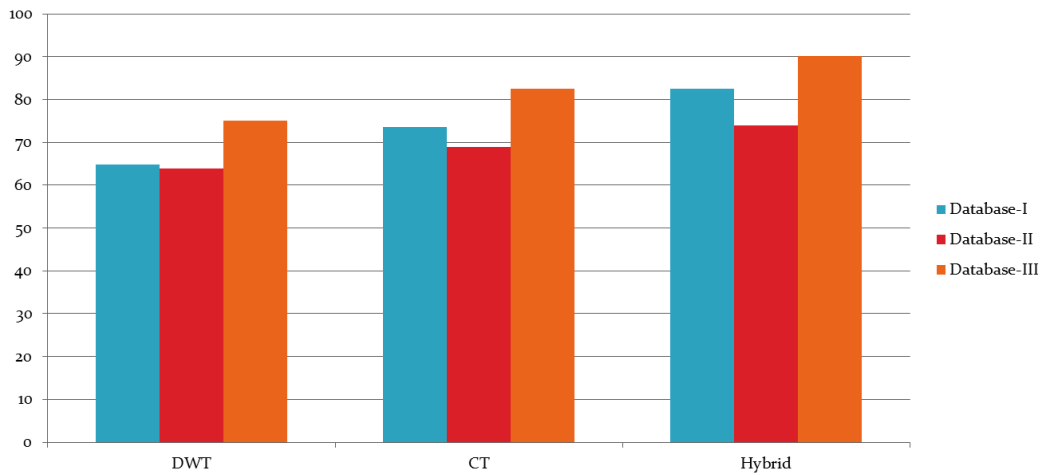

Figure 7: Bar Graph of the PSNR for different technique

V. CONCLUSION

In this research, an improved fusion technique for medical images using Non-subsampled Contourlet Transform (NSCT) and Neural Network (NN) is proposed. This new approach to fuse two medical images with hybrid transform technique is better than other techniques in terms of spatial and spectral quality. The proposed image fusion approach is evaluated for various sets of images in terms of simulation and implementation. In response to the PSNR achieved, the proposed method proves to be effective. The MSE for an image is inversely proportional to the Peak-Signal-to Noise-Ratio (PSNR) and the proposed method achieves low MSE than traditional methods.

REFERENCES

- [1] Yu Song; Mantian Li; Qingling Li; Lining Sun, “A New Wavelet-based Multifocus Image Fusion Technique using Method Noise-Median Filtering”, 4th International Conference on Internet of Things: Smart Innovation and Usages (IoT-SIU), IEEE 2019.
- [2] Lihong Chang, Xiangchu Feng, Xiaolong Zhu, Rui Zhang, Ruiqiang He and Chen Xu, “CT and MRI image fusion based on multiscale decomposition method and hybrid approach”, IET Image Process., Vol. 13 Iss. 1, pp. 83-88, 2019.
- [3] Mohammed Basil Abdulkareem, “Design and Development of Multimodal Medical Image Fusion using Discrete Wavelet Transform”, Second International Conference on Inventive Communication and Computational Technologies (ICICCT), IEEE 2018.
- [4] Bhavana. V, Krishnappa. H.K, “Multi-Modality Medical Image Fusion using Discrete Wavelet Transform”, Procedia Computer Science, elsevier, 70, 625 – 631, 2015.



- [5] Bhavana..V, Krishnappa H.K, “Multi – Modality Medical Image Fusion – A Survey”, International Journal of Engineering Research & Technology (IJERT), Vol.4, Issue 02 , pp. 778-781, 2015.
- [6] Alex PappachenJames, BelurV.Dasarathy, “Medical image fusion: A survey of the state of the art”, Information Fusion, Elsevier, Volume 19, Pages 4-19, 2014.
- [7] Po-Whei Huang, Cheng- I Chen, Phen- Lan Lin, Ping Chen, Li- Pin Hsu, “PET and MRI Brain Image Fusion Using Wavelet Transform with Information Adjustment and Spectral Information Patching”, IEEE International Symposium on Bioelectronics and Bioinformatics, 2014.
- [8] Zhu, X. X., Bamler and R., “Application to Pan-Sharpening.”, IEEE Transaction on Geoscience Remote Sensing and Application, Vol. 51, Issue 04, pp. 2827–2836, IEEE 2013.
- [9] Desale, RajendaPandit, and Sarita V. Verma. “Study and analysis of PCA, DCT & DWT based image fusion techniques” , Proceedings of IEEE International Conference on Signal Processing Image Processing & Pattern Recognition (ICSIPR), p. 66-69, 2013.
- [10] KanisettyVenkataSwathi, CH. HimaBindu, “Modified Approach of Multimodal Medical Image Fusion using Daubechies Wavelet Transform” , International Journal of Advanced Research in Computer and Communication Engineering, p.4199-4201, 2013.
- [11] Rajiv Singh, Richa Srivastava, Om Prakash, Ashish Khare, “Mixed Scheme based Multimodal Medical Image Fusion using Daubechies Complex Wavelet Transform " Proceedings of ,International Conference on Infonnatics , Electronics & Vision, p.304-309, 2012.
- [12] Rubio-Guivernau, J.L., Gurchenkov, V., Luengo-Oroz, M.A., Duloquin, L., Bourguine, P., Santos, A., Peyrieras, N., Ledesma-Carbayo, M.J., “Wavelet-based image fusion in multi-view three-dimensional microscopy”, Bioinformatics Vol. 28, Issue 2, pp. 238-245, 2012.
- [13] Alimuddin, I., Sumantyo, J.T.S., Kuze, H., “Assessment of pansharpening methods applied to image fusion of remotely sensed multibanddata”, International Journal Appl. Earth Obs. Geoinf. 18, pp. 165–175, 2012.
- [14] MaruturiHaribabu, CH HimaBindu, Dr. K. Satya Prasad, “Multimodal Image Fusion of MRI-PET Using Wavelet Transform”, IEEE International Conference on Advances in Mobile Network, Communications and its Applications; 2012.
- [15] ChangtaoHea, Quanxi Liu, Hongliang Lia, Haixu Wang, “Multimodal medical image fusion based on IHS and PCA”, Procedia Engineering, Elsevier, 7, 280–285, 2010.
- [16] Xiao-lin. Zhang, LIU. Zhi-fang, KOU. Young, DAI .Jin-bo, C.Z., “Quality Assessment of Image Fusion Based on Image Content andStructural Similarity”, Proc. 1, 1–4, IEEE 2010.



INNO  **SPACE**
SJIF Scientific Journal Impact Factor

**Impact Factor:
7.512**

ISSN INTERNATIONAL
STANDARD
SERIAL
NUMBER
INDIA



INTERNATIONAL JOURNAL OF INNOVATIVE RESEARCH

IN SCIENCE | ENGINEERING | TECHNOLOGY

 **9940 572 462**  **6381 907 438**  **ijirset@gmail.com**



www.ijirset.com

Scan to save the contact details