



e-ISSN: 2319-8753 | p-ISSN: 2320-6710

# IJIRSET

International Journal of Innovative Research in  
**SCIENCE | ENGINEERING | TECHNOLOGY**

# INTERNATIONAL JOURNAL OF INNOVATIVE RESEARCH

IN SCIENCE | ENGINEERING | TECHNOLOGY

Volume 10, Issue 5, May 2021

**ISSN** INTERNATIONAL  
STANDARD  
SERIAL  
NUMBER  
INDIA

**Impact Factor: 7.512**

9940 572 462

6381 907 438

[ijirset@gmail.com](mailto:ijirset@gmail.com)

[www.ijirset.com](http://www.ijirset.com)



# Design and Performance Analysis of Super Wideband Fractal Defected Ground Structure for 5G Wireless Communication Applications

Kunjan Dubey<sup>1</sup>, Prof. Abhinav Bhargava<sup>2</sup>

Research Scholar, Dept. of ECE, Lakshmi Narain College of Technology Excellence, Bhopal, India<sup>1</sup>

Assistant Professor, Dept. of ECE, Lakshmi Narain College of Technology Excellence, Bhopal, India<sup>2</sup>

**ABSTRACT:** Microstrip antenna is using in most of the electronics application for wireless communication applications. There are various shapes and pattern is proposed by researchers. Microstrip fractal antenna is also an emerging design for 5G wireless communication applications. Many of the 5G wireless communication application lie on the Super wideband (SWB) frequency range. Defected ground structure (DGS) is adopted as an emerging technique for improving the various parameters of microwave circuits, that is, narrow bandwidth, cross-polarization, low gain, and so forth. This paper proposed a novel design of microstrip fractal antenna with DGS for 5G wifi, wi-max etc wireless communication applications at SWB. The CST microwave studio software is used to proposed antenna design and simulation. The resonant frequency of this antenna is 8.9GHz and 14.5GHz. Overall bandwidth achieved by proposed antenna is 9.17GHz. The large bandwidth is applicable for next generation or 5G communication applications.

**KEYWORDS:** Microstrip, Fractal, DGS, SWB, Antenna, CST, FR4, VSWR, Return loss.

## I. INTRODUCTION

With the advancement of remote correspondence advances, it has gotten progressively alluring for present day specialized gadgets to coordinate different correspondence guidelines, for example, 2G/3G/4G/5G. Hence, radio wires with broadband execution are popular for multi-standard inclusion. Fractal antenna is generally utilized in remote correspondence frameworks. To accomplish broadband activity, different plans of fractal reception apparatuses have been accounted for, for example, altering the state of the fractal arms, improving taking care of strategies, stacking parasitic radiators, and utilizing magnetoelectric reciprocal structures [1].

Moreover, radiation execution is additionally required for some remote correspondence applications, for example, indoor sign inclusion, remote passages, and small scale base stations. In view of the multi-mode PFDA, a straightforward and powerful structure to accomplish radiation execution is created by setting two of the proposed PFDA's consecutive. The subsequent reception apparatus displays great radiation designs in the even plane with level increase variety of under 1.27 dB. The introduced conservative broadband radio wire is a decent contender for indoor sign inclusion.

Three resounding modes are gotten by utilizing a changed planar collapsed fractal and its coupled taking care of structure. Consolidating the shorting pins and parasitic patches, numerous resounding modes in the antenna are controlled, moved, and afterward joined to build the impedance data transmission. Utilizing this idea, a model of a multimode collapsed fractal is planned, manufactured, and estimated [1]. Common coupling between two fractal antenna with various measurements put at self-assertive equal positions is broke down utilizing synchronous indispensable conditions with definite parts and limited hole feeds[2]. A tale plan technique for a wideband double enraptured reception apparatus is introduced by utilizing shorted fractals, incorporated baluns, and crossed feed lines. Reenactment and proportionate circuit investigation of the antenna are given. To approve the plan technique, a antenna model is planned, upgraded, manufactured, and estimated [3]. An epic ultra-wide-band firmly coupled fractal reflects array radio wire is introduced in this work. This reflects array antenna comprises of a wideband feed and a wideband reflecting surface. The feed is a log-occasional fractal cluster reception apparatus. The reflecting surface comprises of  $26 \times 11$  unit cells. Every cell is made out of a firmly coupled fractal and a defer line. The base separation between nearby cells is 8 mm, which is around 1/10 frequency at the most minimal working recurrence. By joining the benefits

of reflect array reception apparatuses and those of firmly coupled exhibit radio wires, the proposed TCDR antenna accomplishes ultra wide transfer speed with decreased unpredictability and creation cost [4].



Figure 1. Fractal Antenna

Microstrip fractal radio wire is exceptionally well known in light of the fact that the data transmission of smaller scale strip fractal antenna is high when contrasted with the miniaturized scale strip fix reception apparatus. Small scale strip fractal reception apparatus will be the principle focal point of this work. A miniaturized scale strip fractal is a usage of the customary fractal radio wire on a dielectric chunk, which can be effortlessly created with existing PCB strategies. In contrast to regular small scale strip reception apparatus, that utilization one side of the chunk as the ground plane, the smaller scale strip fractal essentially utilizes the dielectric section as the host material. This antenna is picked in light of the fact that it is straightforward but then has potential for future improvement. A conservative wideband double spellbound antenna with improved upper out-of-band concealment is introduced in this work. The proposed reception apparatus is a proportional arrangement of two electric fractals and two attractive fractals utilizing the crossed shunt circles.

## II. RELATED WORK

**K. Wei et al., [1]** This work presents the circularly polarized (CP) antennas with a restored radiation pattern for the polarization diversity applications. The proposed CP antennas have dual polarizations, the left-handed circularly polarized (LHCP) antenna is designed for transmitting and the right-handed circularly polarized (RHCP) antenna is designed for receiving. The CP antenna operation and the radiation pattern restoration are realized by a fractal defected ground structure (FDGS). When achieving the radiation pattern restoration, the proposed CP antennas forward efficiencies are improved from 66.8% to 81% and the forward realized gains are improved from 2.56 dBi to 5.38 dBic, respectively.

**G. P. Mishra et al., [2]** This article proposes another class of scaled down microstrip patch plan for remote correspondences at 10 GHz. Antenna scaling down is accomplished here by stacking an exceptionally capacitive altered Minkowski fractal (type-2) abandoned ground structure (MFDGS-II) precisely underneath the focal point of the emanating patch. The proposed philosophy includes affectability investigation to choose best DGS design. The full recurrence comparing to the patch is diminished from 16.832 GHz to 10 GHz consolidating MFDGS-II with no adjustment in the physical size of the antenna. This empowers a patch size decrease of as high as 68% and a general volumetric decrease of 84% alongside an improvement in bandwidth and effectiveness of the antenna.

**M. Alibakhshikenari et al., [3]** The proposed exhibit covers the recurrence scope of 8-9.25 GHz for X-band applications, which relates to a fragmentary bandwidth of 14.5%. With the proposed strategy the edge-to-edge hole between contiguous antenna components can be diminished to  $0.5\lambda_0$  with no corruption in the antenna exhibit's radiation gain design. Over the exhibit's working band, the deliberate increase shifts somewhere in the range of 4 and 7 dBi, and the radiation productivity differs from 74.22 and 88.71%. The proposed strategy is appropriate in the execution of intently stuffed patch antenna exhibits utilized in SAR and MIMO frameworks.

**X. Yang, et al., [4]** the proposed fractal UC-EBG structure between the two emanating patches. Additionally, three cross spaces carved on the ground plane are acquainted with further stifle the common coupling. The plan is anything but difficult to be produced without the execution of metal vias, and a progressively minimized cluster with the edge-to-edge separation of  $0.22\lambda_0$  can be encouraged by a line of fractal UC-EBG, which can be very much applied in the patch antenna exhibit.



**P. R. Prajapati et al., [5]** presents the roundabout patch for acknowledgment of CP radiation. To improve the exhibition parameters of patch antenna, for example, hub proportion (AR) bandwidth, return misfortune bandwidth, radiation productivity, etc another strategy of blend of fractal hypothesis and surrendered ground structure (DGS) is proposed without precedent for plan of CP antennas. 44.74% size decrease in patch size, improvements of 62.73% in AR bandwidth, 70.74% consequently misfortune bandwidth and 4.03% in radiation effectiveness is accomplished as contrasted and ordinary patch antenna, after joining of Koch bend fractal DGS in the ground plane.

**S. Costanzo et al., [6]** A Minkowski fractal-molded patch is proposed for the plan of a decreased size reflectarray component. The inherent scaling down capacity of the fractal geometry is completely abused by leaving unaltered the patch length, while utilizing the fractal scaling element to get a decent reflectarray stage dexterity. The accomplished size decrease impact permits to pick cluster lattices with littler interelement separating, in this way offering the chance to have wide-point filtering abilities. As approval test, a fractal-formed X-band reflectarray component, installed into a  $0.3\lambda \times 0.3\lambda$  cell, is intended to give a high stage deftness extend, more noteworthy than  $300^\circ$ . Besides, the plan and the trial approval of a  $15 \times 15$  reflectarray model are introduced to demonstrate the fixed-bar enormous edge pointing capacity.

**M. R. da Silva et al., [7]** This work displays a fractal plan approach for recurrence specific surfaces (FSSs) with Peano pre-fractal patch components. The proposed FSS structures are made out of intermittent varieties of metallic patches imprinted on a solitary layer fiberglass dielectric. The shapes introduced by pre-fractal patches enable one to configuration conservative FSSs that act like double captivated band-stop spatial channels. On the opposite side, the space-filling and self-likeness properties of Peano fractals became conceivable different setups for patch components.

**H. Oraizi et al., [8]** it is explore the conceivable outcomes and properties of the use of Giuseppe Peano fractal geometry for the scaling down of microstrip patch antennas and contrast its presentation and those of the typical fractals, for example, Koch, Tee-Type and Sierpinski. The length of the Giuseppe Peano fractal patch border increments, while its surface territory stays steady with no more space occupation. Subsequently the antenna scaling down, support of its benefit and increment of its relative recurrence bandwidth are accomplished. The proposed antenna has round polarization at one of its reverberation frequencies, which is acknowledged by delivering an annoyance on its underlying structure.

**R. Tiwari et al., [9]** presents we reviewed WBAN communication architecture, security and privacy requirements and security threats and the primary challenges in WBANs to these systems based on the latest standards and publications. This paper also covers the state-of-art security measures and research in WBAN.

**V. Shrivastava et al., [10]** focused on study based various types of microstrip antenna. Return loss, VSWR, bandwidth, resonant frequency and gain is key parameters to judge antenna performance. Good value of return loss is less than -10dB. Considerable range of VSWR is 1-2. CST microwave studio is a advance software to design and simulation of all types of antenna, filter etc.

### III. PROPOSED ANTENNA DESIGN

Figure 2, showing top perspective on proposed microstrip fractal DGS receiving wire, one side of a dielectric substrate goes about as an emanating fractal and opposite side of substrate goes about as ground plane. As in figure 2 demonstrated as follows, top perspectives on a rectangular fractal radio wire with coaxial feed has fractal and ground plane together makes bordering fields and this field is answerable for making the radiation from the receiving wire. Microstrip fractal reception apparatus is proposed because of little size and better reference. Resonant frequency of proposed reception apparatus is approx 8.9GHz and 14.5GHz that implies it work under X and KU-band. Thusly proposed radio wire ought to be valuable for all X-band and KU-band application.

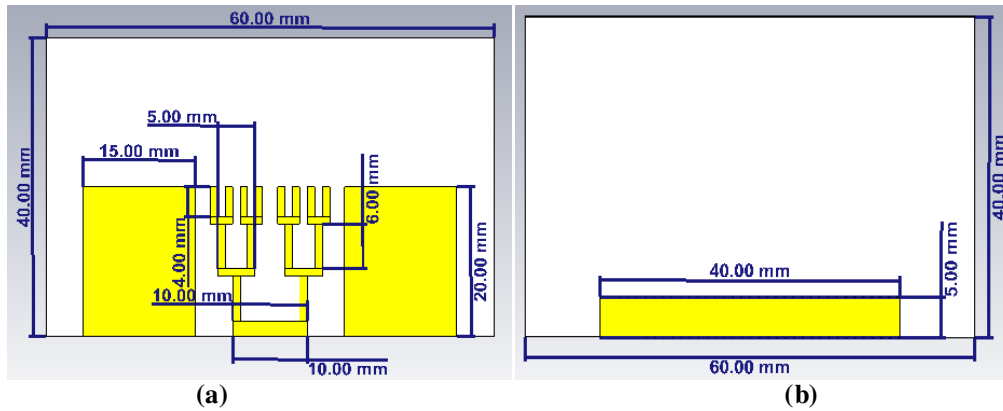
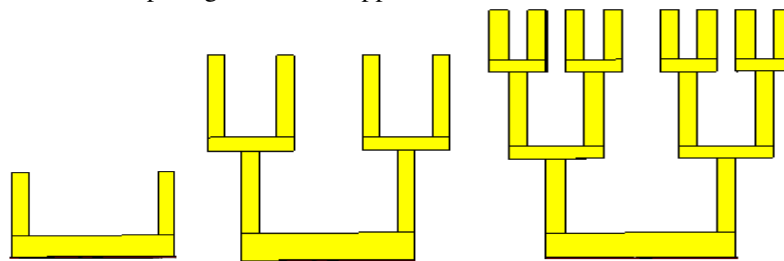

**Figure 2: (a) Top view design and ground (b) Defected Ground Structure of proposed microstrip fractal antenna**

Figure 2 is indicating proposed microstrip fractal antenna of plan. The top and ground layer is made by lossy copper material and substrate is made by FR4 material which having 4.4 dielectric steady worth.

#### IV. SIMULATION AND RESULT

The geometry of the proposed structure of microstrip fractal for x-band and KU-band applications is appeared in figure 2. The general size of the structure is 60mm × 40mm × 1.64mm (L × W × H) and imprinted on fire resistant 4 (FR4), with an overall permittivity of 4.4, and a loss digression of 0.024. Table 1 records the element of the proposed antenna. The antenna is taken care of by 50-Ω and 0.5W coaxial link or straightforward. The antenna utilizes the microstrip fractal structure with one opening for S-Band applications.



**Figure 3: The proposed fractal DGS (a) zero iteration (b) first iteration (c) second iteration.**

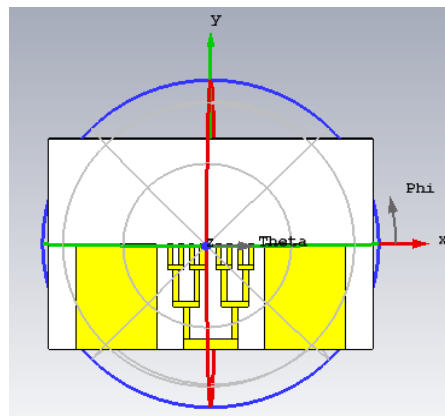

**Figure 4: Simulation and fields of proposed antenna**

CST microwave studio used to recreate the proposed plan. Figure 4 is demonstrating reenacted electric and attractive field in round organize framework.



Table 1: Design parameters for proposed Antenna

Sr No.	Parameter	Value
1	Lower Frequency( $f_L$ )	1 GHz
2	Higher Frequency( $f_H$ )	20 GHz
3	Dielectric constant( $\epsilon_r$ )	4.4 / FR4
4	Ground (LxW)	40 mm X 5 mm
5	Ground height	0.035mm
6	Substrate(LxW)	60mm X 40mm
7	Substrate Height(h)	1.57 mm
8	Line Impedance	50 $\Omega$
9	Tangent Loss	0.06
10	Input watt	0.5W

**Band-I:**

**Return loss**

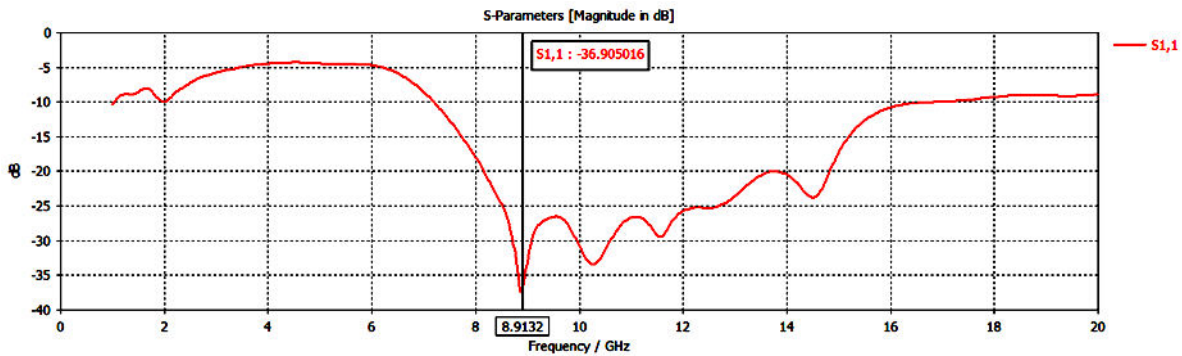

Figure 5: Return loss

Figure 5 presents return loss of proposed structure. It is obvious to see this chart, the return loss estimation of proposed antenna is – 36.90 dB with 8.9 GHz full recurrence.

**Bandwidth**

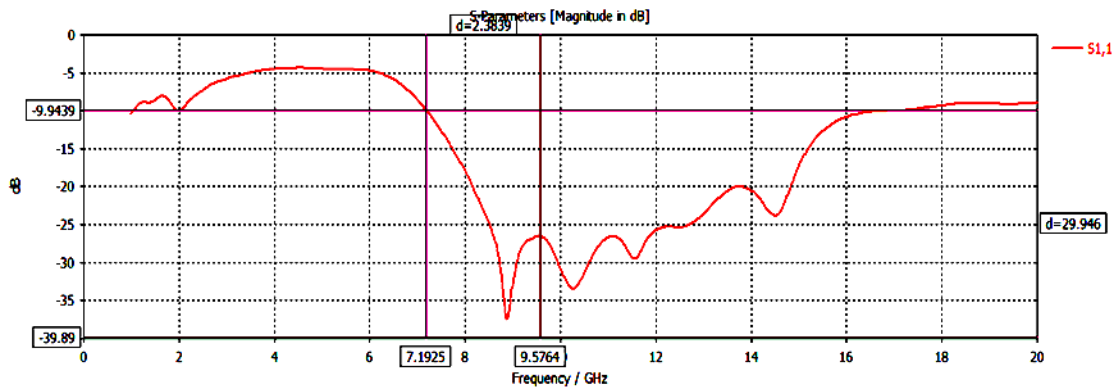

Figure 6: Bandwidth

For broadband antennas, the bandwidth is communicated as a level of the recurrence contrast (upper less lower) over the inside recurrence of the bandwidth.

The bandwidth of proposed antenna is 2839MHz, (9.5964GHz – 7.1925GHz), for first band.



**Voltage Standing Wave Ratio (VSWR)**

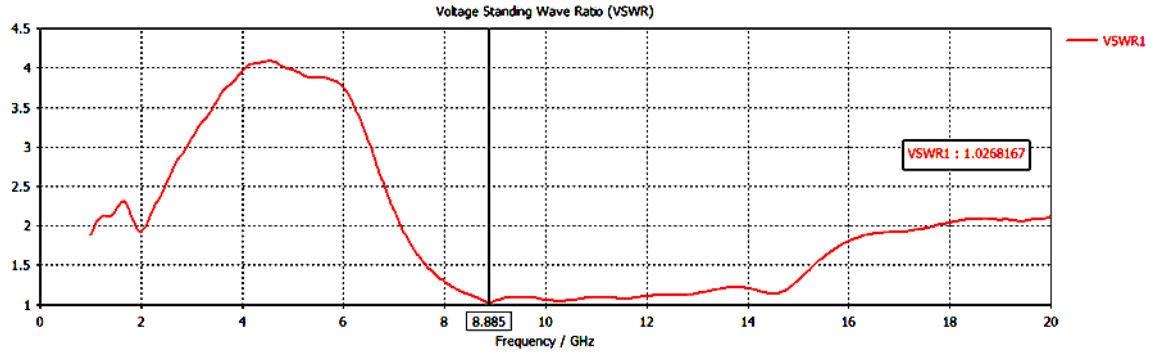

**Figure 7: VSWR**

Figure 7 shows VSWR esteem, it is voltage standing wave proportion, and is likewise alluded to as Standing Wave Proportion (SWR). VSWR is an element of the reflection coefficient, which portrays the force reflected from the antenna. The VSWR estimation of this antenna is 1.026.

**Band-II:  
Return loss**

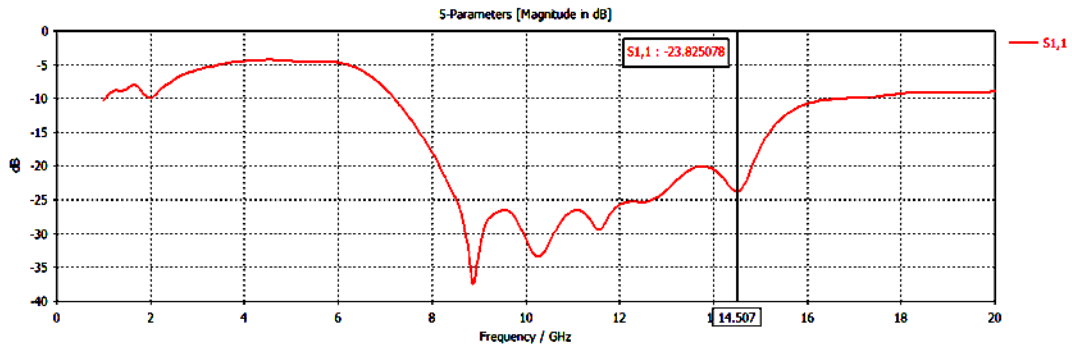

**Figure 8: Return loss**

Figure 8 presents return loss of proposed structure. It is obvious to see this chart; the return loss estimation of proposed antenna is -23.82 dB with 14.50GHz thunderous recurrence.

**Bandwidth**

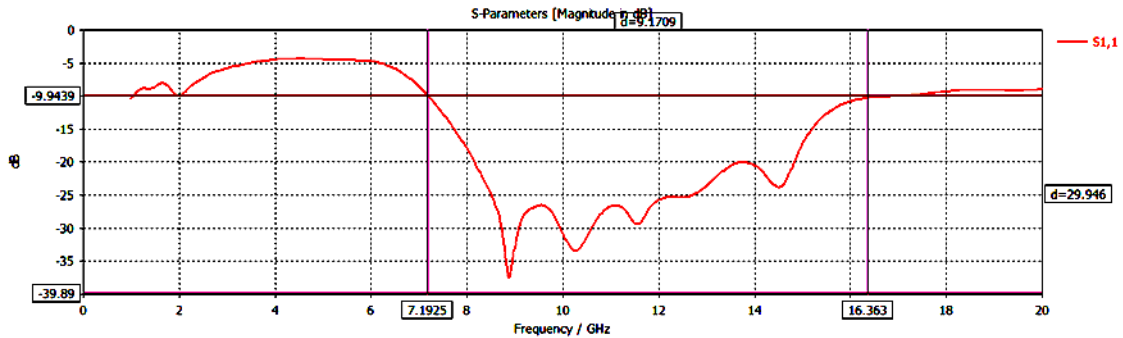

**Figure 9: Bandwidth**

The overall bandwidth of proposed antenna is 9170MHz, (16.363GHz – 7.1925GHz), for entire band.

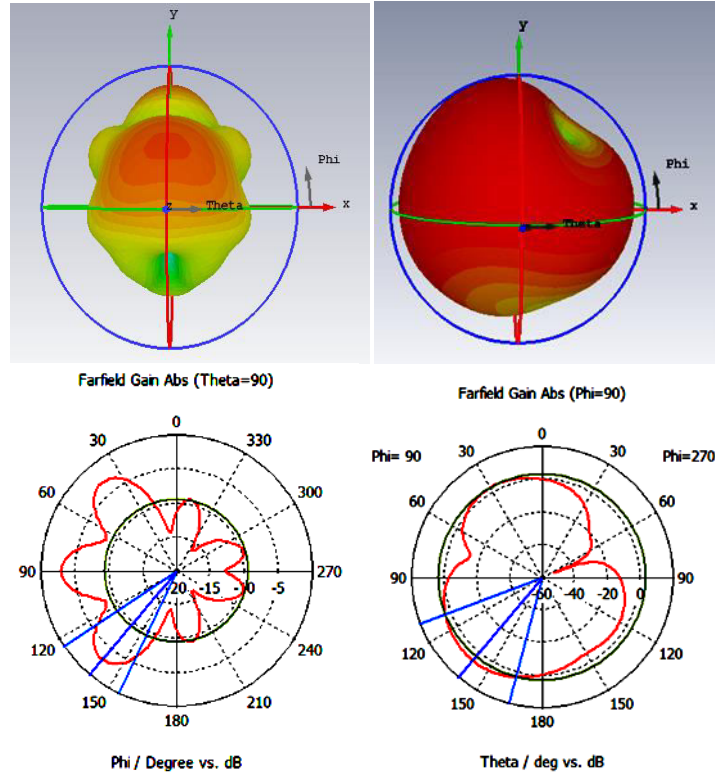

Figure 10: Radiation pattern

Figure 10 shows radiation pattern of proposed antenna bands. It is a variety of the force transmitted by an antenna as an element of the heading ceaselessly from the antenna.

Table 2: Simulated Results of Proposed Antenna

Sr No.	Parameter	Value
1	Return loss or S11	-36.90 dB
2	Bandwidth	9.17GHz
3	VSWR	1.026
4	Resonant Frequency	8.9GHz, 10.285GHz, 11.56GHz, 14.50 GHz
5	Directivity	9.146dBi
6	Gain	6.077dB

Table 2 shows about terms of every vital parameter like return loss, bandwidth, VSWR and resonating recurrence. It is clear by observing reenacted values from table 2, proposed antenna accomplish significant improved outcome.

### V. CONCLUSION

A multi band, microstrip fractal antenna is planned and recreated utilizing CST microwave studio software. The reproduction results are introduced and examined. Structure of proposed antenna is basic and reduced in size of 60x40x1.6 mm<sup>3</sup>. Reenacted results exhibit that the antenna bandwidth covers X band and KU-band, at full recurrence 8.9 GHz and 14.5GHz for VSWR under 2, and S11 beneath - 10 dB. The bandwidth is huge accomplished better than existing micorstrip antenna structure. Micorstrio fractal antenna configuration is recently exploring theme among





specialists. The overall bandwidth is approx 10GHz. Subsequently proposed antenna is reasonable and meets to 5G wireless communication requirements and suitable for X and KU band applications.

#### REFERENCES

- [1] K. Wei, B. Zhu and M. Tao, "The Circular Polarization Diversity Antennas Achieved by a Fractal Defected Ground Structure," in *IEEE Access*, vol. 7, pp. 92030-92036, 2019, doi: 10.1109/ACCESS.2019.2927280.
- [2] G. P. Mishra and B. B. Mangaraj, "Miniaturised microstrip patch design based on highly capacitive defected ground structure with fractal boundary for X-band microwave communications," in *IET Microwaves, Antennas & Propagation*, vol. 13, no. 10, pp. 1593-1601, 14 8 2019.
- [3] A. Arif, M. Zubair, M. Ali, M. U. Khan and M. Q. Mehmood, "A Compact, Low-Profile Fractal Antenna for Wearable On-Body WBAN Applications," in *IEEE Antennas and Wireless Propagation Letters*, vol. 18, no. 5, pp. 981-985, May 2019.
- [4] M. Alibakhshikenari *et al.*, "Study on isolation improvement between closely-packed patch antenna arrays based on fractal metamaterial electromagnetic bandgap structures," in *IET Microwaves, Antennas & Propagation*, vol. 12, no. 14, pp. 2241-2247, 28 11 2018.
- [5] A. T. Abed, M. S. J. Singh and M. T. Islam, "Compact fractal antenna circularly polarised radiation for Wi-Fi and WiMAX communications," in *IET Microwaves, Antennas & Propagation*, vol. 12, no. 14, pp. 2218-2224, 28 11 2018.
- [6] X. Yang, Y. Liu, Y. Xu and S. Gong, "Isolation Enhancement in Patch Antenna Array With Fractal UC-EBG Structure and Cross Slot," in *IEEE Antennas and Wireless Propagation Letters*, vol. 16, pp. 2175-2178, 2017.
- [7] H. Oraizi, A. Amini and M. Karimi Mehr, "Design of miniaturised UWB log-periodic end-fire antenna using several fractals with WLAN band-rejection," in *IET Microwaves, Antennas & Propagation*, vol. 11, no. 2, pp. 193-202, 29 1 2017
- [8] P. R. Prajapati, G. G. K. Murthy, A. Patnaik and M. V. Kartikeyan, "Design and testing of a compact circularly polarised microstrip antenna with fractal defected ground structure for L-band applications," in *IET Microwaves, Antennas & Propagation*, vol. 9, no. 11, pp. 1179-1185, 20 8 2015..
- [9] S. Costanzo and F. Venneri, "Miniaturized Fractal Reflectarray Element Using Fixed-Size Patch," in *IEEE Antennas and Wireless Propagation Letters*, vol. 13, pp. 1437-1440, 2014.
- [10] V. V. Reddy and N. V. S. N. Sarma, "Compact Circularly Polarized Asymmetrical Fractal Boundary Microstrip Antenna for Wireless Applications," in *IEEE Antennas and Wireless Propagation Letters*, vol. 13, pp. 118-121, 2014.
- [11] M. R. da Silva, C. de Lucena Nobrega, P. H. da Fonseca Silva and A. G. D'Assuncao, "Stable and compact multiband frequency selective surfaces with Peano pre-fractal configurations," in *IET Microwaves, Antennas & Propagation*, vol. 7, no. 7, pp. 543-551, 15 May 2013.
- [12] H. Oraizi and S. Hedayati, "Miniaturization of Microstrip Antennas by the Novel Application of the Giuseppe Peano Fractal Geometries," in *IEEE Transactions on Antennas and Propagation*, vol. 60, no. 8, pp. 3559-3567, Aug. 2012.
- [13] D. Oloumi, S. Ebadi, A. Kordzadeh, A. Semnani, P. Mousavi and X. Gong, "Miniaturized Reflectarray Unit Cell Using Fractal-Shaped Patch-Slot Configuration," in *IEEE Antennas and Wireless Propagation Letters*, vol. 11, pp. 10-13, 2012.
- [14] J. Eichler, P. Hazdra, M. Capek, T. Korinek and P. Hamouz, "Design of a Dual-Band Orthogonally Polarized L-Probe-Fed Fractal Patch Antenna Using Modal Methods," in *IEEE Antennas and Wireless Propagation Letters*, vol. 10, pp. 1389-1392, 2011.
- [15] J. J. Casanova, J. A. Taylor and J. Lin, "Design of a 3-D Fractal Heatsink Antenna," in *IEEE Antennas and Wireless Propagation Letters*, vol. 9, pp. 1061-1064, 2010.
- [16] H. Rmili, J. Floch and H. Zangar, "Experimental Study of a 2-D Irregular Fractal-Jet Printed Antenna," in *IEEE Antennas and Wireless Propagation Letters*, vol. 8, pp. 328-331, 2009.



**INNO**  **SPACE**  
SJIF Scientific Journal Impact Factor

**Impact Factor:  
7.512**

**ISSN** INTERNATIONAL  
STANDARD  
SERIAL  
NUMBER  
**INDIA**



# INTERNATIONAL JOURNAL OF INNOVATIVE RESEARCH

IN SCIENCE | ENGINEERING | TECHNOLOGY

 **9940 572 462**  **6381 907 438**  **ijirset@gmail.com**



[www.ijirset.com](http://www.ijirset.com)

Scan to save the contact details