



e-ISSN: 2319-8753 | p-ISSN: 2320-6710

IJIRSET

International Journal of Innovative Research in
SCIENCE | ENGINEERING | TECHNOLOGY

INTERNATIONAL JOURNAL OF INNOVATIVE RESEARCH

IN SCIENCE | ENGINEERING | TECHNOLOGY

Volume 10, Issue 5, May 2021

ISSN INTERNATIONAL
STANDARD
SERIAL
NUMBER
INDIA

Impact Factor: 7.512

9940 572 462

6381 907 438

ijirset@gmail.com

www.ijirset.com

Multi-Carrier CDMA in a Spread Spectrum Radar

Nilas Gurung¹, Aman Gupta¹, Ovais Rizwan¹, Arun Kumar Singh², Sisir Chettri³

Student, Department of Electronics and Communication Engineering, Sikkim Manipal Institute of Technology, Sikkim, India¹

Assistant Professor, Department of Electronics and Communication Engineering, Sikkim Manipal Institute of Technology, Sikkim, India²

Student, Department of Electrical and Electronics Engineering, Sikkim Manipal Institute of Technology, Sikkim, India³

ABSTRACT:In this paper, a simulation model of Multi-Carrier Code Division Multiple Access (MC-CDMA) Radar has been designed for the target detection in MATLAB. Multi-Carrier Code Division Multiple Access (MC-CDMA) method has been used in the radar as it is one of the most efficient spread spectrum technology which combines the advantages of both Code Division Multiple Access(CDMA) and Orthogonal Frequency Division Multiplexing (OFDM) which solves the problem of Intersymbol-Interference (ISI) while sending data over multipath channels hence improving the performance and significantly producing a spectrally efficient multi-user radio access system. Further, the BPSK(Binary Phase Shift) modulation technique has been used in the model. The performance of this Radar has been compared with the LFM (Linear Frequency Modulation) Radar which is already available in the MATLAB in the presence of both the AWGN(Additive White Gaussian Noise) channel and the Rayleigh fading channel.

KEYWORDS:Multicarrier Code Division Multiple Access (MC-CDMA), Linear Frequency Modulation (LFM), Orthogonal Frequency Division Multiplexing(OFDM), Additive White Gaussian Noise (AWGN), Binary Phase Shift Keying (BPSK), Fast Fourier Transform(FFT), Inverse Fast Fourier Transform(IFFT), Rayleigh Channel.

I. INTRODUCTION

RADAR (Radio Detection and Ranging) is a system that primarily works on the principle of transmission of the pulses of radio waves to determine the range, altitude, direction, or speed of objects. It can be used to detect aircraft, ships, spacecraft, guided missiles, motor vehicles, weather formations, and terrain. When these pulses come into contact with an object they are usually reflected or scattered in many directions. The reflected radar signals back by the objects towards the transmitter and its detection by the receiver's antenna makes the basic functioning principle of the radar system. The object can be stationary or moving either towards or away from the transmitter. There is also a slight change in the frequency of the reflected radio waves caused by the deflection due to the moving objects known as the Doppler effect. Further, the radar system receivers may or may not be in the same location as that of the location of the transmitter. Therefore, the reflected radar signals by the objects which are captured by the receiver's antenna are usually very weak and thus require to be strengthened by using electronic amplifiers. Hence, various sophisticated methods of signal processing are required in the radar system in order to recover proper radar signals for its efficient functioning.

Therefore, the Spread Spectrum method known as Multi-Carrier Code Division Multiple Access has been employed in the radar system for its efficient functioning and detection of radio pulses. In telecommunication and radio communication, Spread-spectrum is a technique in which signal is transmitted on a bandwidth considerably larger than the frequency content of the original information. Therefore spread spectrum has various advantages such as secure communication, resistance to interference, noise and resistance to fading where high bandwidth occupied by spread-spectrum signals offer some frequency diversity where it is unlikely that the signal will encounter severe multipath fading over its whole bandwidth.



II. WORKING PRINCIPLE OF MC-CDMA RADAR

The Radar system has numerous applications such as in the observation of moving objects, in the field of vehicle communication where it can be used to effectively control vehicle from collisions while driving and parking, in a rescue service to detect people buried under building obstructions, etc.[1].

The Multi-Carrier CDMA combines the advantages of multi-user access of CDMA (Code Division Multiple Access) with multi-carrier modulation techniques such as OFDM (orthogonal frequency domain multiplexing) to produce the spectrally efficient multi-user radio access system [2].

The CDMA (Code Division Multiple Access) is a spread spectrum method primarily used in various radio communication technologies where the several transmitters can send information simultaneously over the single communication channel. Each user in the CDMA system uses different spreading code to modulate their signal. At the receiver's end the appropriate code is again used to recover the particular signal intended for a particular user. If the signal matches the desired user's code then the correlation will be high and the system can extract the signal. In case the desired user's code has nothing in common with the intended signal then the correlation is zero thus rejecting the multi-path interference.

Another important aspect of the MC-CDMA model is the use of OFDM technique which is based on a principle of multicarrier modulation, which means dividing a data stream into several bit streams (sub channels), each of which has a much lower bit rate than the parent data stream. These sub streams are then modulated using codes that are orthogonal to each other. Because of their orthogonality, the subcarriers can be very close to each other in the frequency spectrum without interfering each other. And since the symbol times on these low bit rate channels are long, there is no inter-symbol interference (ISI). The result is a very spectrum-efficient system. OFDM allows simple equalization of signals in frequency selective channels with severe inter-symbol interference and fading caused by multi-path interference. This is achieved by increasing the symbol length, at the cost of increasing the number of carriers used to transmit the information, thus keeping the same data rate. This can be easily and efficiently implemented by taking the FFT (Fast Fourier Transform) of a block of data symbols[3].

In Multi-Carrier CDMA system, the signal is spread and then it is converted from serial to parallel data streams, which is then transmitted over multiple sub-carriers. If the spreading factor is equal to the no. of the carriers then this system modulates all the carriers with the same data bit but with a phase shift on each carrier determined by the spreading code.

The MC – CDMA system considered here employs N sub carriers

i.e. $N = \text{no. of sub carriers.}$

$M = \text{no. of bits transmitted by each user during one signalling interval.}$

$G = \frac{N}{M} = \text{spreading factor or processing gain.}$

The Hadamard Walsh code is being used for spreading.

$e_g^u = \text{u}^{\text{th}} \text{user's spreading sequence.}$

$g = 0, 1, \dots, G-1.$

for $M = 1$, i.e. single bit $G = N$.

The complex baseband representation of the transmitted signal $s(t)$ in a certain signalling interval can be written as

$$s(t) = \sum_{u=0}^{U-1} \sum_{m=0}^{M-1} \sum_{g=0}^{G-1} \sqrt{E_c} b_m^u c_g^u e^{j2\pi \frac{1}{T}(gM+m)t} \quad (1)$$



Where,

U= no. of users and $U_{max}=G$

M= no. of bits transmitted per user

G= spreading factor

E_c = chip energy, $E_c = \frac{E_b}{N}$, E_b bit energy.

T = signalling interval during which M no. of bits per user are transmitted.

$f_c = \frac{1}{T}$ = sub carrier spacing

b_m^u is the m^{th} bit of user 'u'

c_g^u is the g^{th} chip of u^{th} user.

Further, in our model, the data for transmission has been modulated by using BPSK(Binary Phase Shift Keying) technique which is the simplest and the most robust of all PSK(Phase Shift Keying) technique showing small error than any other system and hence is used in high speed data transfer application[4].

The general form for BPSK follows the equation:

$$s_n(t) = \sqrt{\frac{2E_b}{T_b}} \cos(2\pi f_c t + \pi(1 - n)), n = 0, 1. \tag{2}$$

This yields two phases, 0 and π .

In the specific form, binary data is often conveyed with the following signals:

for binary "0"

$$s_0(t) = \sqrt{\frac{2E_b}{T_b}} \cos(2\pi f_c t + \pi) = -\sqrt{\frac{2E_b}{T_b}} \cos(2\pi f_c t) \tag{3}$$

for binary "1"

$$s_1(t) = \sqrt{\frac{2E_b}{T_b}} \cos(2\pi f_c t) \tag{4}$$

where f_c is the frequency of the carrier-wave. Hence, the signal-space can be represented by the single basis function

$$\phi(t) = \sqrt{\frac{2}{T_b}} \cos(2\pi f_c t) \tag{5}$$

where 1 is represented by $\sqrt{E_b}\phi(t)$ and 0 is represented by $-\sqrt{E_b}\phi(t)$.

This spread spectrum Multi-carrier CDMA technique [5] has been implemented in our radar system for the target detection whose performances varies directly in the presence of the channel. The spread spectrum technology is employed for better spectral efficiency, enhances spreading codes security, solves radio wave propagation problems in multipath fading channel. Moreover, it can easily adapt to severe channel conditions and mitigates the inter-symbol interference (ISI) and fading caused by multipath propagation.

With respect to the testing of the MC-CDMA Radar in Multi-path effects, the AWGN(Additive White Gaussian Noise) channel and Rayleigh channel are being used for comparison. AWGN channel is often used as a channel model in which the only impairment to the communication is a linear addition of wideband or white noise with a constant spectral density and Gaussian distribution of amplitude. The AWGN channel is a good model for many satellite and deep space communication links. However, it is not a good model for most terrestrial links because it does not account for fading, frequency selectivity, multipath, terrain blocking and interference. Whereas, Rayleigh fading channel is a model that can be used to describe the form of fading that occurs when multipath propagation exists with no line-of-sight path from the transmitter to the receiver and hence with reduced signal strength where the radio signal travels through a significant no. of paths. This can be used to represent the channel conditions seen on a terrestrial area and a busy street in a city where the base station is hidden behind several blocks away and arriving signal is bouncing off many scattering objects in the local area. When the signals reach the receiver, the overall signal is a combination of all the signals that have reached the receiver via the multitude of different paths that are available.

III. METHODOLOGY

The complete schematic block diagram of the MC-CDMA Radar is being given below:

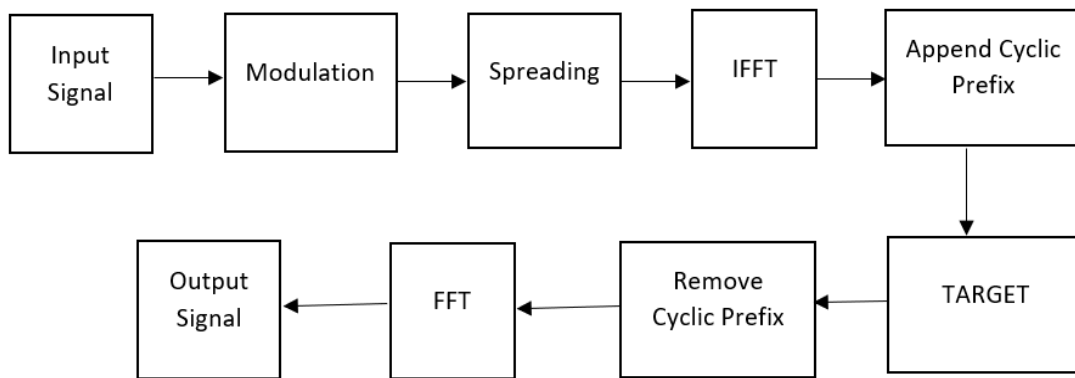

Fig.1. Schematic block diagram of MC-CDMA Radar.

The input signal is generated randomly using a MATLAB code. We took 10 bits for generation of the input signal. The input waveform can be seen as following in figure 2(a). The figure 2(b) shows the BPSK modulated waveform

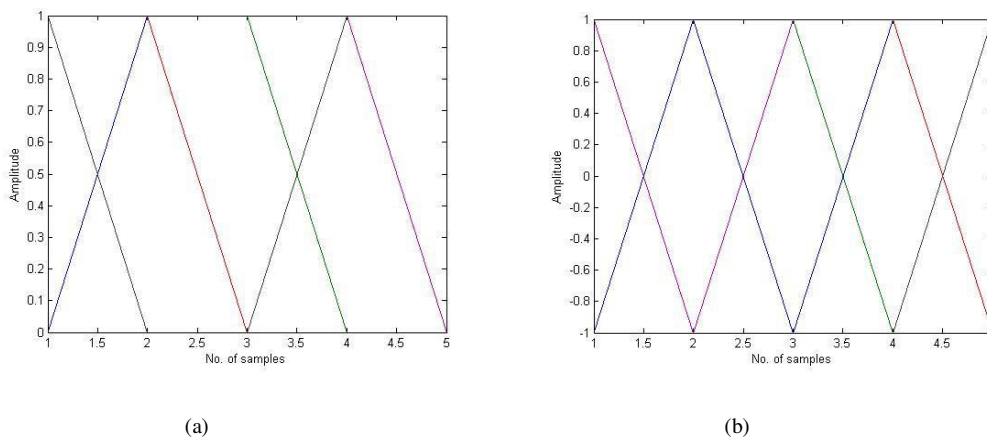

Fig. 2. (a) Input waveform and (b) BPSK modulated waveform.



Spreading Operation

Spreading operation means increasing the signal bandwidth and in our model the spreading is done using orthogonal codes. The main objective of spreading operation is to separate different users. The spreading operation is done by using the Hadamard code in our simulation model because of its orthogonal properties.

The 2nd row of the Hadamard matrix is taken for this operation. The figure (3) shows the waveform after the spreading operation.

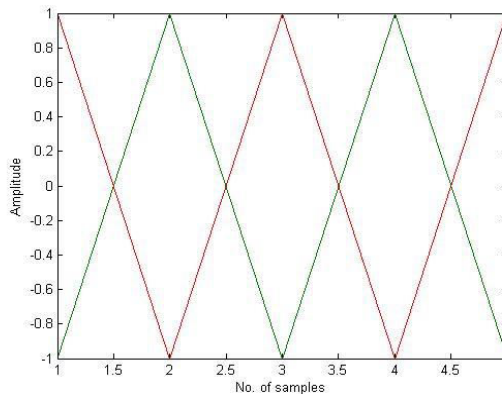

Fig. 3. Spreading of BPSK modulated waveform.

IFFT/FFT Operations

The IFFT operation is carried out in the transmitter side of the MC-CDMA Radar model to provide sub-carriers to the symbols. In our simulation model, we have taken 64 no. of sub-carriers.

The FFT operation is done to remove the sub-carriers in the receiver side of of MC-CDMA Radar model. The IFFT/FFT operations comes under the OFDM block of MC-CDMA.

An OFDM signal consists of *N* orthogonal subcarriers modulated by *N* parallel data streams. Each baseband subcarrier is of the form

$$\phi_k(t) = e^{j2\pi f_k t} \tag{6}$$

where *f_k* is the frequency of the *k*th sub-carrier.

One baseband OFDM symbol (without a cyclic prefix) multiplexed *N* modulated subcarriers:

$$s(t) = \frac{1}{\sqrt{N}} \sum_{k=0}^{N-1} x_k \phi_k(t), \text{ where } 0 < t < NT \tag{7}$$

where *x_k* is the *k*th complex data symbol (typically taken from a PSK or QAM symbol constellation) and *NT* is the length of the OFDM symbol. The subcarrier frequencies *f_k* are equally spaced which is given by

$$f_k = \frac{k}{NT} \tag{8}$$



which makes the subcarriers ϕ_k on $0 < t < NT$ orthogonal. The signal separates data symbols in frequency by overlapping subcarriers, thus using the available spectrum in an efficient way. The FFT operations is implemented in the receiver side to remove the sub-carriers.

Cyclic prefix

The term cyclic prefix refers to the prefixing of a symbol with a repetition of the end which serves two purposes. As a guard interval, it eliminates the Inter-symbol Interference (ISI) from the previous symbol. As a repetition of the end of the symbol, it allows the linear convolution of a frequency-selective multipath channel to be modelled as circular convolution, which in turn may be transformed to the frequency domain using a discrete Fourier transform. In order for the cyclic prefix to be effective, the length of the cyclic prefix must be at least equal to the length of the multipath channel.

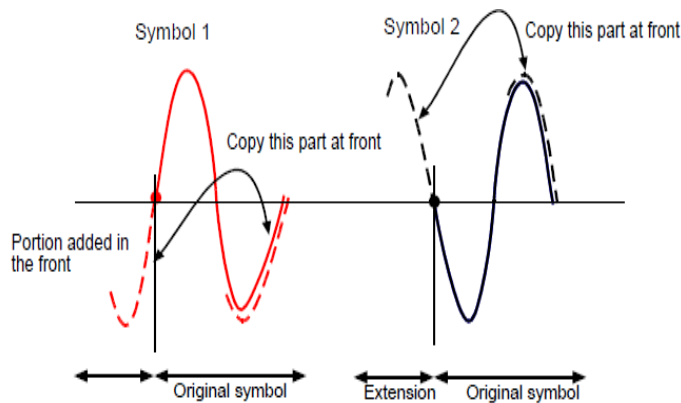

Fig. 4. It shows the copying of back portion of symbol to the front.

PROGRAM ANALYSIS:

The following MATLAB code has been used in designing our MC-CDMA Radar :

Transmitter section of MC-CDMA RADAR:

```
clc;
clear all;
close all;
```

1. Generation of Walsh code:

Here, we have used 64 no. of data sub-carriers and we have taken 2nd row of the walshhadamard code:

```
n = 64 ;                               Number of Data Sub-Carriers
walsh = hadamard(n) ;
code = walsh(2,:);                     Taking 2nd row of walsh code for User1
```

2. Generating random data:

Here, we are generating random data with 10 bits.

```
N = 10;                                Number of Bits for data
data_user = rand(1,N) > 0.5;           Generation of random data
```



3. Performing BPSK modulation:

Here we are modulating the data using BPSK modulation as follows:

```
data_userbpsk = 2*data_user-1;
```

BPSK modulation 0 -> -1; 1 -> 0

4. Spreading Operation :

Here, we are performing the spreading operation i.e., multiplying the BPSK modulated data by the hadamard code which we have taken from 2nd row of the hadamard matrix in the above.

```
data_user1=data_userbpsk';  
spdata_user=data_user1*code;  
spdata=(spdata_user)'
```

Spreading

5. Performing IFFT operation:

Here, we are performing the IFFT operation of the above spreaded data.

```
ifftdata_user=ifft (spdata12);  
ifftdata1=ifftdata_user';
```

Taking the IFFT

6. Append Cyclic Prefix:

Here we are appending the cyclic prefix of the above generated data

```
y1=[ifftdata1 (:,(n-2):n) ifftdata1];  
transdata =y1';
```

Append Cyclic Prefix

Now, we are sending the above generated signal to the target.

Receiver section of MC-CDMA RADAR:

Now, after receiving the signal in the receiver side from the target, the following operations are performed:

7. Removing Cyclic Prefix:

Here, we are removing the cyclic prefix as follows.

```
rx1=(output of target)';  
rx3 = rx2(:,[(4:(n+3))]);  
rx4=rx3';
```

8. Taking FFT :

Here, we are performing the FFT operation as follows.

```
yout =fft(rx4);
```

After performing the FFT operation, we are correlating the transmitted signal with the received signal in the output.

IV. SIMULATION RESULTS

The modelling and simulation of MC-CDMA Radar is being done using MATLAB. The point target has been used for the target detection. The different parameters of target used in our simulation model includes:

Distance= 10m.

Radar cross-section = 1m².

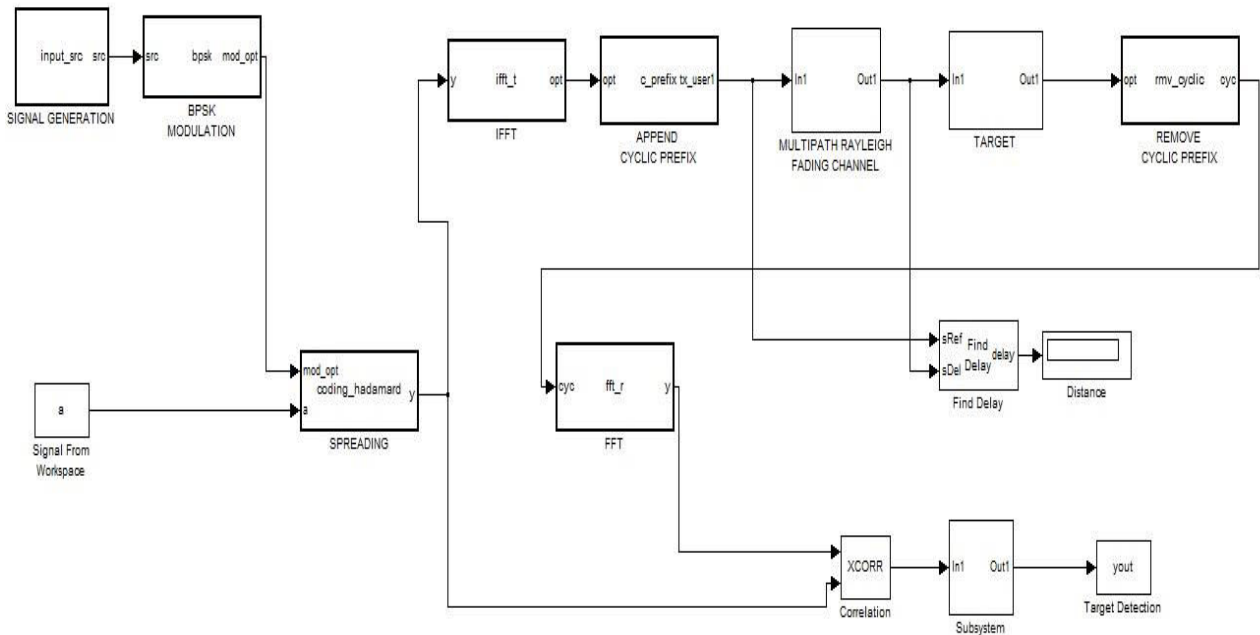

Fig.5. A complete simulation model of the MC-CDMA RADAR.

The following figures (6) and (7) shows the results of the detection plots for both the LFM (Linear Frequency Modulation) Radar and MC-CDMA Radar under the presence of AWGN channel and Rayleigh fading channel. Here, we are taking only one sample of the detection peak. The amplitude of the detection peak can be seen varying in plots shown in figures.

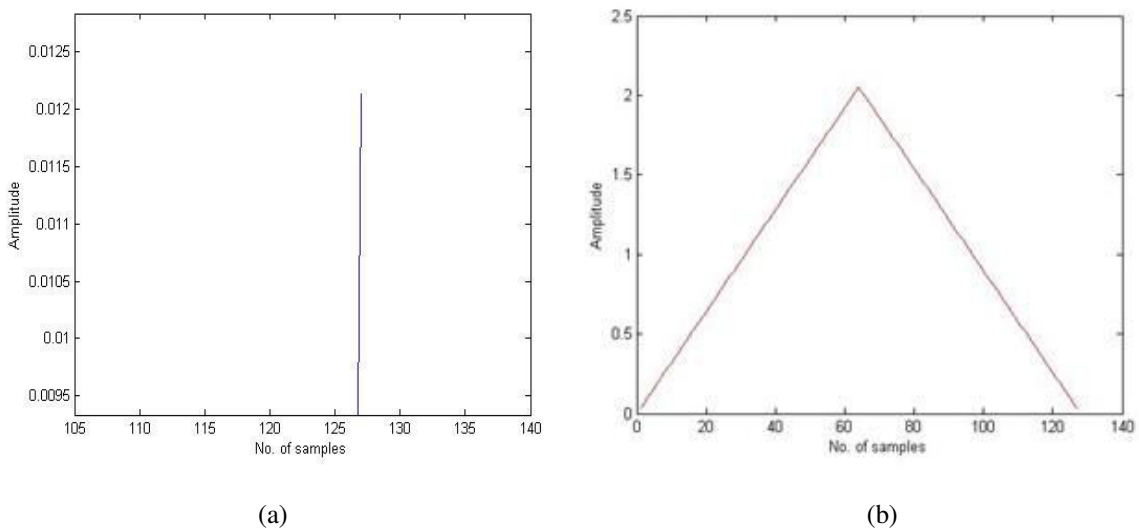

Fig. 6. Target detection (a) Detection plot of LFM Radar in AWGN Channel and (b) Detection plot of MC-CDMA Radar in AWGN Channel.

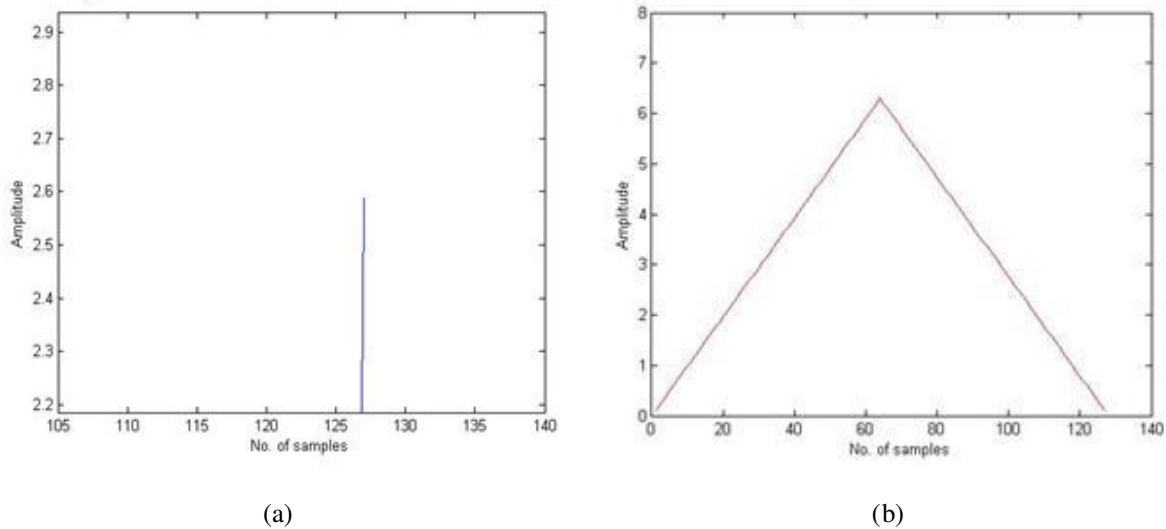

Fig. 7. Target detection (a) Detection plot of LFM Radar in Rayleigh Channel and (b) Detection plot of MC-CDMA Radar in Rayleigh Channel

V. CONCLUSION

The principle objective of this work was the design and implementation of the MC-CDMA (Multi-Carrier Code Division Multiple Access) Radar and comparison of the performance of the MC-CDMA Radar with the LFM Radar in the presence of the AWGN (Additive White Gaussian Noise) and the Rayleigh channel. We found that the MC-CDMA Radar shows a better performance and response in the detection of the target than LFM Radar in the presence of both the AWGN channel and Rayleigh fading channel which can be seen in the amplitude detection of the respective graphs.

REFERENCES

- [1] A. K. Singh, S.N. Sur, A. Agarwal and R. Bera, "A Complete Simulation of Target Detection and Estimation Using 77 GHz Radar," International Journal of Engineering Science and Technology, Vol. 4 No. 02, 2012.
- [2] Branislav M. Popović, "Spreading Sequences for Multicarrier CDMA System," IEEE Transaction on communication, Vol. 4, No. 6, 1999.
- [3] Necmi TASPINAR, S. I. AKKAYA, "Generalized Type-II Hybrid SRARQ Scheme Using Punctured Convolutional Coding and Code Combining Technique in Multi-Carrier Code Division Multiple Access (MC-CDMA) Systems," 2012.
- [4] B. O. Omijeh, C. E. Adabanya, "Computer Based Comparative Analysis of BPSK versus Other PSK Modulation Models" International Journal of Advanced Research in Computer and Communication Engineering, Vol. 4, 2015.
- [5] N. B. Sinha, M. Sonal, R. Bera, M. Mitra, "Implementation of Digital Radar Technology for Imaging and Remote Sensing in Intelligent Transport," Progress In Electromagnetic Research C, Vol. 11, 213-228, 2009.
- [6] V. J. Naveen, K. M. Krishna, K. R. Rajeswari, "Performance Analysis of MC-CDMA and OFDM in wireless Rayleigh Channel," International Journal of Advanced Science and Technology, Vol. 25, 2010.



INNO  **SPACE**
SJIF Scientific Journal Impact Factor

**Impact Factor:
7.512**

ISSN INTERNATIONAL
STANDARD
SERIAL
NUMBER
INDIA



INTERNATIONAL JOURNAL OF INNOVATIVE RESEARCH

IN SCIENCE | ENGINEERING | TECHNOLOGY

 **9940 572 462**  **6381 907 438**  **ijirset@gmail.com**



www.ijirset.com

Scan to save the contact details