



e-ISSN: 2319-8753 | p-ISSN: 2347-6710

IJIRSET

International Journal of Innovative Research in
SCIENCE | ENGINEERING | TECHNOLOGY

INTERNATIONAL JOURNAL OF INNOVATIVE RESEARCH

IN SCIENCE | ENGINEERING | TECHNOLOGY

Volume 11, Issue 8, August 2022

ISSN INTERNATIONAL
STANDARD
SERIAL
NUMBER
INDIA

Impact Factor: 8.118

9940 572 462

6381 907 438

ijirset@gmail.com

www.ijirset.com

Behaviour Pattern of Piers in Metro Rail Project under Wind and Seismic Forces

Prof. Dr. Satish Patil¹, Prof. Anandrao Jadhav², Mr. Amit Shrikhande³

¹Hod & Prof., MIT – ADT School of Engineering, Pune, Maharashtra, India

²Asst. Professor, MIT – ADT School of Engineering, Pune, Maharashtra, India

³PG Student, Department of Civil Engineering, MIT – ADT School of Engineering, Pune, Maharashtra, India

ABSTRACT In general, the most suitable choices for improvement of India is prone to severe earthquakes in the last century. More than 50 % area in the country is considered critical to damaging earthquakes. There is a country wide attention to the seismic behaviour of existing buildings comparatively existing bridges have less. However, bridges are extensively important components of the transportation sector in any country. According to antiquated building rules, the bulk of Indian bridges were insufficiently designed to withstand seismic and wind pressures. For short piers, the design shear capacities (With an aspect ratio of two to three) is discovered that it should be lesser than the comparable under flexural shear demand overstrength conditions. There is a lot of literature capable of designing and analysing the piers. Nonetheless, the discussion and study regarding an arrangement and seismic performance of double-decker bridge metro pier are not done, a seismic load is applied to a pier 20m height situated in the zone III. Later the process of analysis is completed employing STAAD software. An Axial force, bending moment, shear force, time period, and the storey displacements are calculated, also the location of plastic hinge formation is computed.

KEYWORDS: STAAD, Response Spectrum Analysis, Seismic Responses, Metro.

I. INTRODUCTION

INDIA is one of the world's most powerful countries for earthquakes in the recent century. In fact, more than 50% of percent area in the country is suffering due to damaging earthquakes. However, bridges are very important components of the transportation network for the development of any country. According to antiquated building rules, the bulk of Indian bridges were built insufficiently to withstand seismic and wind pressures.

For short piers, the shear capacity of the design (having an between the aspect ratios of Two to Three) are found to be lesser in the condition of flexural overstrength, than the corresponding shear demand. **Apurva Yawale [1]** Paper is subjected to Seismic Vulnerability Assessment of Bridge using plastic hinge Analysis. In contrast to previous elastic analyses, the nonlinear pushover analysis has been proposed. Several nonlinear pushover analysis methods have been developed, with an emphasis on new approaches. Bridges extend horizontally with their two ends restricted, which distinguishes them from structures in terms of dynamic qualities. **Mohammad Farhan and Mohd. Tasleem [2]** Plastic hinges are related to this paper. IRC-6 Codal Provision Design Analysis of Reinforced Concrete Bridge Pier In most circumstances, the pushover analysis performance point is somewhere between Life Safety and Immediate Occupancy. As a result, the Pushover approach requires that the structure is more than linear yielding.

Because the disparity in demand between Pushover and Codal is so large, it is advised that non-linear static analysis be used in Indian Codes. **Ashish Gupta [3]** Paper indicates that it has been observed from comparative study that long pier bridge for MPA in mode 2 is weakest and it shows ductile behavior in comparison to short pier bridge. The similar behavior has also been observed by ADRS method. It has been observed from comparative study that short bridge pier it fails in MPA in mode 2, it doesn't show ductile behavior as shown by long bridge pier. It exhibits brittle behavior in comparison to long pier bridge and similar behavior has been reported by ADRS It has been observed that bridge with short and long column shows intermediate displacement and has base shear. Bridge with unequal pier shows Unpredictable behavior and base shear reported is maximum as reported by different methods. **Alessandro Vittorio Bergami, Bruno Briseghella [4]** The approach in this research work maintains the simplicity and minimal processing effort of a traditional pushover analysis. In reality, while IMPA necessitates the execution of one nonlinear static analysis for each loading pattern, IDA necessitates the execution of numerous nonlinear response history studies, one for each of the seven ground motions, and it must be repeated for each intensity level examined.

II. OBJECTIVES OF THE STUDIES

- To determine the seismic performance and lateral deflections of the typical reinforced concrete Metro pier designed as per Indian codes.
- To evaluate the various responses of structure such as base shear, lateral displacement.
- To Determine the differences of base shear and lateral displacement.
- To determine the deflection check for the wind load as per codal provision.

III. METHODS OF ANALYSIS

A. Equivalent Static Analysis Method

The dynamic character of seismic loads must be taken into account in every designs. However, similar static linear techniques are insufficient for analyzing simple regular structures. Most of the low- to medium-rise building codes of practice allow this. For this approach Dynamic analysis is not required.; rather, it approximates building dynamics. The static technique is the easiest because it involves less processing work and it is based on formulas in the practice code. Design foundation base shear, determined for entire building at first and after then followed by distribution together with the building's height. The resultant lateral forces are allocated to the individual's lateral load resisting equipment at each floor level.

B. Response Spectrum Method

The dynamic linear analysis approach is the response spectrum method. The highest crest responses shown by the structure during a natural disaster (earthquake) are directly calculated from the seismic response (or design) spectrum using this appropriate method. During earthquake ground motion, the assumed maximum response SDOF systems with a particular damping and time period are represented. The maximum response can be defined in associates of max. relative displacement or max. relative displacement and is plotted versus the natural period with no damping and for various damping levels.

IV. STRUCTURAL MODELING AND ANALYSIS

The Example considered contains seismic analysis of pile with IRS and IRC code provisions. Pile, Pile cap, and pier till the level of the flyover are designed with both the codes and. The pier above the flyover level is designed as per IRS code specifications. Viaduct levels load are calculated as per IRS and flyover level loads are calculated as per IRC. The following data is considered for analysis: Type of Structure – cantilever double-decker pier, No. of Stories – 2, Zone (Z) – III, Response reduction factor (R) – 1 for Pile, Pile cap and 3 for Pier, Importance factor (I) – 1.5, Live load – As per IRS and IRC, Height of Pier – 20m, Soil

strata – Hard, Density of concrete – 25 kN/m^3 , M-35 for Pile, Pile cap and M40 to M50 for Pier and M55 for Superstructure concrete and FE-500D steel is used.

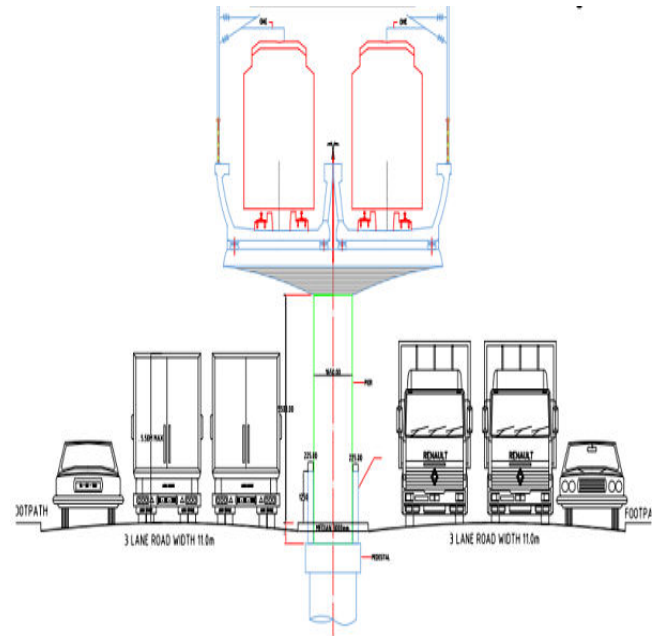

Fig. 1 Elevation of Pier for Metro

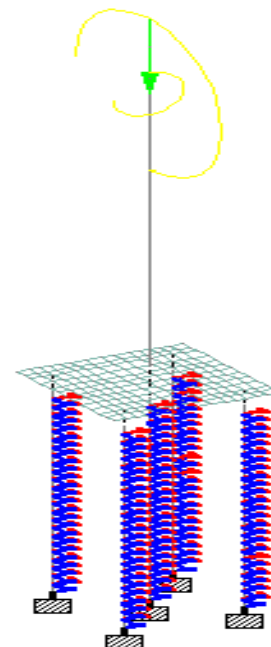

Fig. 2 Elevation of Pier and Piles model in STAAD

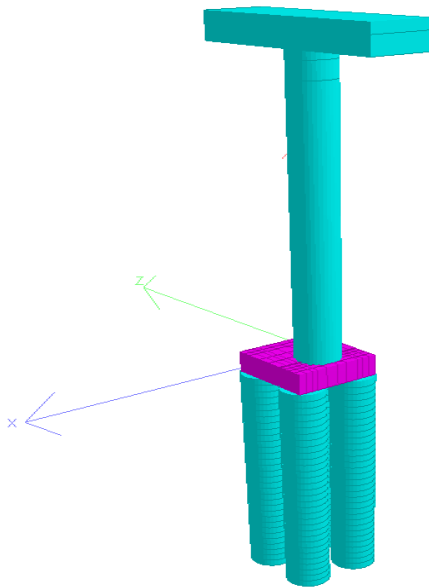

Fig. 3 3D Elevation of Pier and Piles model in STAAD

V. RESULTS & DISCUSSION

The Analytical study of displacement, base shear, and Plastic Hinge formation in a parametric manner of Plastic Hinge formation in spectrum analysis for a variety of stories Double-decker pier is performed here. The resulting conclusions obtained from the analysis, and are mentioned down below in the paper.

A. Pier deflections

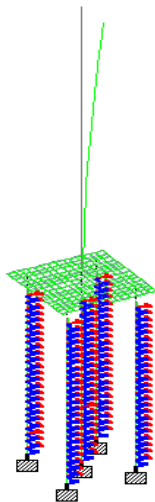

Fig. 4 Pier deflection in Wind case as per UIC 776

It has been observed that Pier with Tall heights say above 20m and in curvature, spans are critical for wind case and shall satisfy UIC

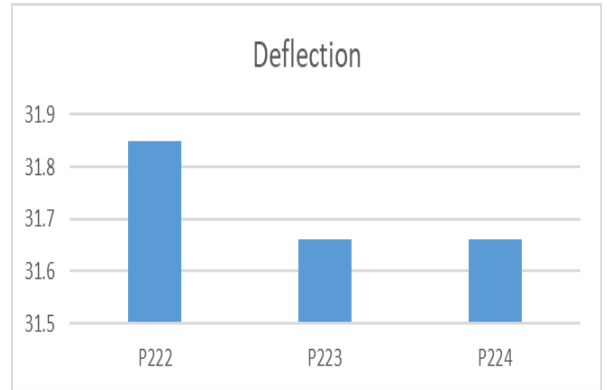

Fig.5 Maximum Lateral Displacement (mm) in Z Direction for Circular 1.8m diameter Pier

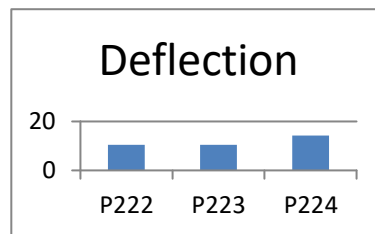

Fig.6 Maximum Lateral Displacement (mm) in Z Direction for oblong diameter Pier

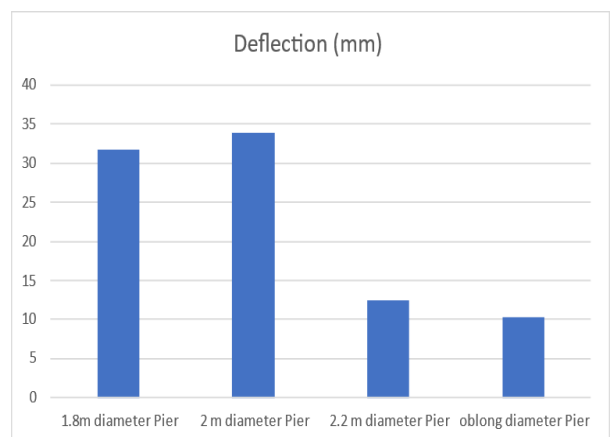

Fig. 7 Comparison of max. lateral displacement in mm for z direction for different dia piers

B. BASE SHEAR

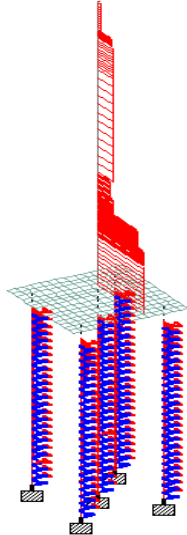

Fig.8 Base Shear in Pier

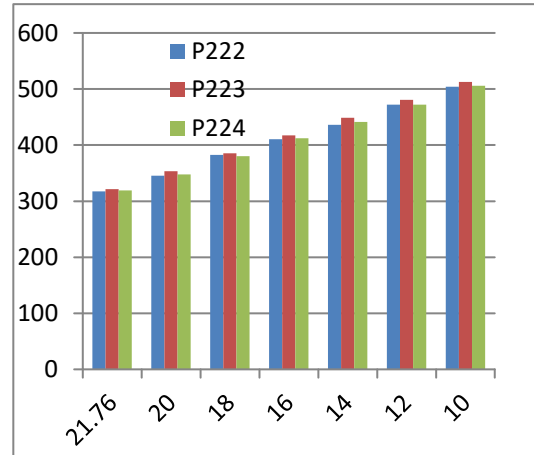

Fig.10 Base Shear (kN) in Z Direction

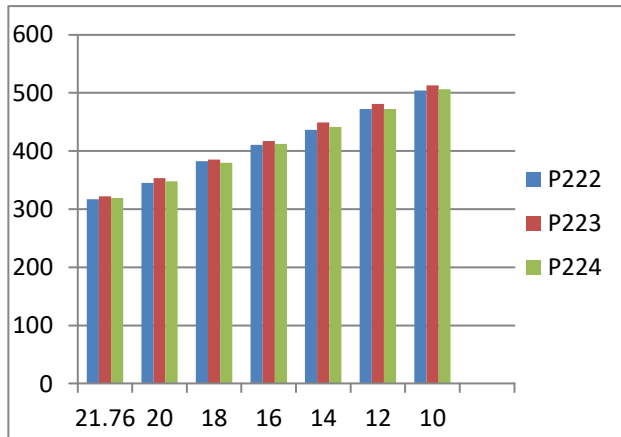

Fig.9 Base Shear (kN) in X Direction

VI. CONCLUSION

According to above findings, the following are the conclusions reached.

1. Base shear for the short pier will be more than the tall piers and accordingly shear reinforcement requirement will be more.
2. The lateral deflection in the long pier with curved spans will be more and the shape and size of the pier required may be different.
3. The emergence (formation) of Plastic hinge will be present at the bottom (base) of the circular pier and for that accordingly, reinforcement shall be provided satisfying the seismic code.

REFERENCES

- [1] Bureau of Indian Standards (BIS). Plain and Reinforced Concrete Code of Practice IS 456-2000, New Delhi. Apurwa Yawale (2014). Seismic Vulnerability Assessment of Bridge using Pushover Analysis, IJERTV3IS20631 www.ijert.org
- [2] Farhan, M., & Tasleem, M. (2020). Pushover Analysis of Reinforced Concrete Bridge Pier Designed as Per IRC-6 Codal Provision.
- [3] Ashish Gupta (2015). Pier pushover analysis of the short and long bridge, National institute of technology
- [4] Camillo Nuti, Alessandro Vittorio Bergami, Gabriele Fiorentino, Bruno Briseghella and Davide Lavorato (2020). Incremental Modal Pushover Analysis for Bridges, Appl. Sci. 2020, 10, 4287
- [5] Limin SUN and Chennan ZHANG (2004). Improvement of pushover analysis taking account of pier-pile-soil interaction, 13th World Conference on Earthquake Engineering Vancouver, B.C., Canada August 1-6, 2004, Paper No. 659

- [6] D.S. Wang, Q.H. Ai, H.N. Li, B.J. Si and Z.G. Sun (2008). Displacement based seismic design of RC bridge piers: Method and experimental evaluation, The 14th World Conference on Earthquake Engineering October 12-17, 2008, Beijing, China
- [7] R np Singh, Hemant Kumar Vinayak (2015). Seismic bridge pier analysis for pile foundation by force and displacement-based approaches, fact Universitatis series: architecture and civil engineering vol. 13, no 2, 2015, pp. 155 – 166 Doi: 10.2298/fuace15020157s
- [8] R. Pouca, N. V., & Faria, Delgado (2000). Seismic behaviour of r/c bridge piers: numerical simulation and experimental validation. In The 12th World Conference on Earthquake Engineering (No. 0673).
- [9] Constantine c Spyarakos and Michael j Karantzikis (2000). Seismic analysis of bridges including soil-abutment interaction, the 12th world conference on earthquake engineering 2000
- [10] Yang, F., Zhang, Y., Zheng, T., & Li, B. (2016, May). Application of Pushover Analysis in Bridge Piers. In The 2016 International Forum on Energy, Environment and Sustainable Development, Shenzhen, China.
- [11] R N P Singh, Dr. Hemant Vinayak (2015). Assessment of Soil-Structure Interaction in Seismic Bridge Pier Analysis Using Force and Displacement Based Approaches, SSP - JOURNAL OF CIVIL ENGINEERING Vol. 10, Issue 2, 2015, DOI: 10.2478/space-2015-0023
- [12] Farhan, M., & Tasleem, M. A Review on Seismic Analysis of RCC Bridge with Non Linear Pushover Analysis.
- [13] Kulkarni, Adhikary, Sengupta and Singh (2014) "Seismic performance of a bridge with tall piers" ICE Publishing Accepted 10/10/2014
- [14] Harshavardhan Sule Patil, M L.Waikar (2017) "Literature Review on Design of Metro Bridge Piers. ISSN (Print): 2347 – 6710
- [15] IRC-6 Standard Specification & Code of Practice for Road Bridges- Loads and Stresses- 2017. Code shall be read in continuation with the relevant portion of notification no. 2 published in Indian Highway – January 2018.
- [16] PAYGHAN, P. N., & SAWAI, G. (2017). Analysis and design of bridge foundation.
- [17] IRC 83 Standard Specifications & Code of Practice for Road Bridges, Part-III Pot, Pot-Cum-PTFE, Pin, and Metallic Guide Bearings. Code shall be read in continuation with the relevant portion of notification no. 29 published in Indian Highway – Feb 2020.
- [18] IRC 112 Code of Practice for Concrete Road bridges- 2011.
- [19] IRC 86 Geometric Design of Urban Roads – 1983.
- [20] IRC 92 Guidelines of Design of Interchanges in Urban Area – 2017.
- [21] IRC SP-114 Guidelines for Seismic Design of Road Bridges – 2018.
- [22] IRS Bridge Rules – 2014
- [23] IRS Substructure & Foundation Code -2013
- [24] IRS: Concrete Bridge Code – 2014
- [25] IRS: Steel Bridge Code – 2003
- [26] IRS Seismic Code for Earthquake Resistant Design of Railway Bridges, Seismic code 2020



INNO SPACE
SJIF Scientific Journal Impact Factor
Impact Factor: 8.118



ISSN INTERNATIONAL
STANDARD
SERIAL
NUMBER
INDIA



INTERNATIONAL JOURNAL OF INNOVATIVE RESEARCH

IN SCIENCE | ENGINEERING | TECHNOLOGY

 **9940 572 462**  **6381 907 438**  **ijirset@gmail.com**



www.ijirset.com

Scan to save the contact details