



e-ISSN: 2319-8753 | p-ISSN: 2347-6710

# IJIRSET

International Journal of Innovative Research in  
**SCIENCE | ENGINEERING | TECHNOLOGY**

# INTERNATIONAL JOURNAL OF INNOVATIVE RESEARCH

IN SCIENCE | ENGINEERING | TECHNOLOGY

Volume 11, Issue 11, November 2022

**ISSN** INTERNATIONAL  
STANDARD  
SERIAL  
NUMBER  
INDIA

Impact Factor: 8.118

9940 572 462

6381 907 438

ijirset@gmail.com

www.ijirset.com



# Study on Advanced Water Treatment by Acoustophoresis

R Chandan<sup>1</sup>

U.G. Student, Department of Mechanical Engineering, Sir M Visvesvaraya Institute of Technology, Bangalore, Karnataka, India<sup>1</sup>

**ABSTRACT:** Acoustics wave technology could be the way to catching and isolating substrates from water without channels, filters, or synthetic substances. Acoustophoresis, in which the droplets, or particles inside a fluid can be controlled with an uncommon acoustic wave design. The wave design applies acoustic forces that predicament substances scattered in the fluid into clusters. Depending upon their relative density contrasted with the fluid those large clusters either settle to the base or ascend to the surface, where they can be isolated without any problem. The current subject matter provides, among other possible advantages, a solid-state, low-cost alternative to filter cartridges and filter membranes that is capable of processing large quantities of a host medium, for example water, that is laden with microorganisms or other suspended particles. Various implementations of the current subject matter can efficiently trap, concentrate, and separate such microorganisms and particles from the host medium. Methods can rupture the cell walls and cellular membranes of microorganisms and can also concentrate and remove metal, metal oxide, and other types of particles without clogging a filter or a membrane. Systems or methods can rupture the cell walls and cellular membranes of microorganisms and can also concentrate and remove metal, metal oxide, and other types of particles without clogging a filter or a membrane. Acoustophoresis can be used to sort particles of different sizes, density, or compressibility in a single pass through an acoustophoretic cavity.

**KEYWORDS:** Acoustophoresis, Acoustic Wave Technology, Acoustophoretic cavity.

## I. INTRODUCTION

The subject matter described here in relates to the use of ultrasonically generated acoustic standing waves to achieve trapping, concentration, and separation of suspended-phase components and thereby remove such contaminants from a fluid medium such as water. There is great interest and need for water purification for developing countries. The world population is approximately 6.7 billion people and is expected to be over 8 billion by 2050. Roughly 1.1 billion people in the world lack access to safe drinking water. Available water sources can be contaminated by pathogens. Roughly 2.2 million die each year from consumption of pathogen contaminated water and 9500 children die each day. Most of the work reported in the literature for pathogen removal from water involves replaceable filter units. These units generally consist of packed cartridges, filter membranes, or special filter papers. Though organisms over 10 microns can be easily captured by these techniques, smaller organisms including bacterial spores in the size range of 1 micron are typically not captured with sufficient efficiency. Various implementations of the current subject matter can efficiently trap, concentrate, and separate such microorganisms and particles from the host medium. The current subject matter describes an apparatus including a flow chamber with an inlet and an outlet through which is flowed a mixture of a fluid and a particulate, and two or more ultrasonic transducers embedded in or outside of a wall of said flow chamber. When the two or more ultrasonic transducers are located outside the flow chamber wall the thickness of the flow chamber wall can be tuned to maximize acoustic energy transfer into the fluid. The ultrasonic transducers are arranged at different distances from the inlet of the flow chamber. The ultrasonic transducers can be driven by an oscillating, periodic, or pulsed voltage signal of ultrasonic frequencies. Ultrasound waves can also rupture the cellular walls of microorganisms and can separate smaller microorganisms such as *Leptospira*, and *Salmonella* from water sources for human and livestock consumption. Acoustophoresis can be used to sort particles of different sizes, density, or compressibility in a single pass through an acoustophoretic cavity.



## II. RELATED WORK

### ACOUSTIC TECHNIQUE PRESENTS FRESH TAKE ON WATER TREATMENT

Paper published by - **Jason Dionne, Simsbury and Bart Lipkens, Hampden.**

When oil and gas are extracted from the Earth, water also comes to the surface. Known as produced water, it contains naturally occurring hydrocarbons, salt, bacteria, radioactive material and other compounds, as well as any chemical additives used to ease extraction. Each year, the U.S. alone generates more than 21 billion barrels (approximately 900 billion gallons) of produced water from oil and gas extraction, including hydraulic fracturing. To treat this water before disposal or re-use, the industry depends on filtration and separation technologies. Typically, dispersed particles or droplets are removed from a host liquid using a series of complex techniques. These techniques are energy-intensive and may require the addition of chemicals to work. They have also proven inefficient at removing the tiniest oil droplets and contaminants. With funding from the National Science Foundation (NSF), Flo Design Sonics, a small business based in Wilbraham, Massachusetts, has developed a new, efficient separation technology that can help clean produced water. The company's design uses acoustic waves to continuously capture and separate substances from water or other liquids without using filters or chemicals. Flo Design Sonics demonstrated their separation technology at the White House Water Summit March 22. As shown in figure(a)

### SOUND SEPARATION

Paper by - **Edward A. Rietman, Nashua, NH (US).**

At the heart of Flo Design Sonics' system is a method called acoustophoresis, in which droplets or particles within a liquid can be manipulated with a special acoustic wave pattern. The new system uses a pattern of ultrasonic waves in the megahertz range. The wave pattern exerts acoustic forces that bind substances dispersed in the liquid into clusters. Depending on their relative density compared to the liquid, these larger clusters either settle to the bottom or rise to the surface, where they can be separated easily. "Acoustophoresis has been used primarily in microfluidics and other microscale systems," explained Jason Dionne, co-founder and senior engineer of Flo Design Sonics. "When the U.S. Army was looking for a technology for rapid detection of anthrax spores in large bodies of water, we got the idea to develop an acoustic separation technology that works at the macroscale. "Flo Design Sonics' patented system, called Acoustic Wave Separation (AWS), was designed to treat produced water from hydraulic fracturing (fracking) operations that extract natural gas. The amount of produced water generated at a fracking site change over the lifetime of the well and depends on the geologic formation but can reach 100,000 gallons per day. It's challenging for current technologies to remove particles smaller than 20 microns without the addition of chemicals. "AWS separates particulates, oil droplets, sand and bacteria as small as 1 micron." Produced water treated with the AWS system meets or exceeds the Environmental Protection Agency's standards for safe discharge. "With NSF funding, the technology has scaled up to an industrially relevant scale. They now have a 7,000-gallon per day prototype that are ready to pilot with a partner. The ultimate goal of technology within the oil and gas industry is to build a system capable of processing 100,000 gallons per day. Figure(1) illustrates the diagram of a sample microfilter

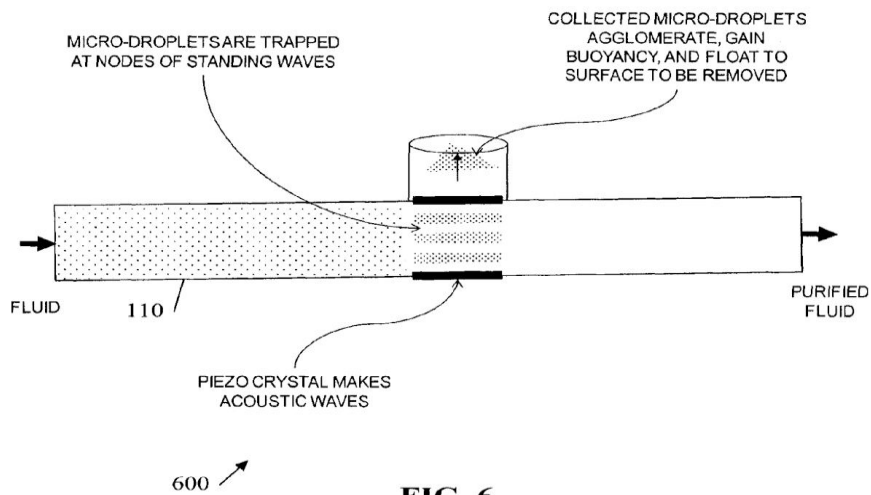

**FIG. 6**  
Figure (1) Diagram illustrating a sample acoustic microfilter.

## DISINFECTION MECHANISMS DURING ULTRASOUND IRRADIATION

Paper by - **Burzio et al, Doulah, Lorimer, & Mason**

Extensive investigations were conducted on US disinfection techniques. The energy generated during American irradiation in several combined mechanisms based on acoustic cavitation can inactive microorganism. The primary mechanism suggested is the disruption of turbulences that produces vortexes, shock waves and high shear stresses, which are developed by dissipation of viscaneddia, near the rates of shear that are more than the shear rate throughout the liquid's bulk, Second, high bubble-related stress, and falling bubbles would raise fluid temperature to more than 2000 k and increase the pressure by 26 to more than 330 atm; Microbial mortality is largely caused by cell dilution, localization and free radical growth. Bacterial cell forces are induced by cavitation as a result of the surface resonance. Stresses from the dissolution of gas bubbles approaching and touching the cell wall of a bacterial solution. These effects could be summarized as

- Mechanical fatigue induces bacterial cell disruption over a period of time, which depends on frequency 86.
- Micro-stray shear forces occur within bacterial.
- Chemical attack in the marine environment by free radicals (OH<sup>-</sup> and H<sup>+</sup>).



- We strike the bacterial cell wall chemistry structure and degrade the cell wall until it disintegrates.

As a consequence, the processes of disinfection depend on two primary phenomena induced by the cavitation. The first is the break-up of bacterial clusters. Firstly, the death of bacteria (or inactivation), which leads to a reduced reproductive potential for a suspension of the bacteria. The overall effect of ultrasound application is ultimately attributed to a rivalry of solution division and inactivation of bacteria.

### SCOPE OF ULTRASONIC WATER TREATMENT

There is great interest and need for water purification for developing countries. The world population is approximately 6.7 billion people and is expected to be over 8 billion by 2050. Roughly 1.1 billion people in the world lack access to safe drinking water. Available water sources can be contaminated by pathogens. Roughly 2.2 million die each year from consumption of pathogen contaminated water and 9500 children die each day. Most of the work reported in the literature for pathogen removal from water involves replaceable filter units. These units generally consist of packed cartridges, filter membranes, or special filter papers. Though organisms over 10 microns can be easily captured by these techniques, smaller organisms including bacterial spores in the size range of 1 micron are typically not captured with sufficient efficiency.

The current Subject matter provides, among other possible advantages, a Solid-state, low-cost alternative to filter cartridges and filter membranes that is capable of processing large quantities of a host medium, for example water, that is laden with microorganisms or other Suspended particles. Various implementations of the current Subject matter can efficiently trap, concentrate, and separate such microorganisms and particles from the host medium. Systems, methods, and the like according to the current Subject matter can rupture the cell walls and cellular membranes of microorganisms and can also concentrate and remove metal, metal oxide, and other types of particles without clogging a filter or a membrane.

### OTHER VARIOUS SCOPE

- Membrane filtration
  - Application of ultrasound for turbidity and total suspended solid reduction
  - Applications of ultrasound in organic pollutants degradation
  - Application of ultrasound for water disinfection process
- a. Disinfection by ultrasound irradiation
  - b. Disinfection by ultrasound irradiation coupled to other processes.
  - c. Ultrasound and chemicals synergistic effect.
  - d. Sonication and ozonation synergistic effect.
  - e. Ultrasound and electrolysis disinfection efficiency.



Ultrasound and ultraviolet synergistic effect



a.

b.

Figure (2) Picture shows the Bellandur and Varthur lakes. Industrial effluents and solid waste being dumped into lakes leading to, formation of foam, lake fires.

**ULTRASONIC FORCES AND SOUND THEORY**

Ultrasound is cyclic sound pressure with a frequency greater than the upper limit of human hearing. Although this limit varies from person to person, it is approximately 20 kilohertz (20,000 hertz) in healthy, young adults and thus, 20 kHz serves as a useful lower limit in describing ultrasound.

**SOUND THEORY**

Sound can be described as mechanical energy transmitted by pressure waves in a material medium. Thus, sound can be described as a form of energy, or a sound is said to be mechanical. This distinguishes sound energy from other forms of energy, such as electromagnetic energy. This general definition encompasses all types of sound, including audible sound, low-frequency seismic waves (infrasound), and ultrasound. In a transmission medium such as a gas, liquid or solid, sound can be represented as mechanical energy transmitted by pressure waves. Sound can therefore be defined as a mechanical energy. This overall definition encompasses all forms of noise, including visible, low frequency seismic and ultrasound waves. Ultrasound is cyclic sound pressure, which reaches the upper limit of human hearing, the frequency is about 20 kilohertz. Figure(3) shows a Ultrasound range diagram.

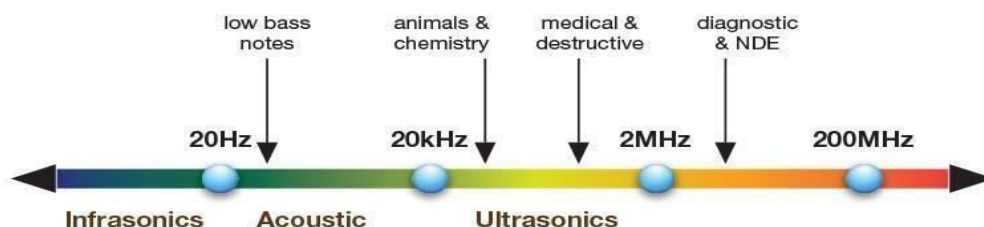

Figure (3)-Ultrasound range diagram

US could be generate by two main techniques, the first is called “magneto strictive” in which electrical energy is converted to mechanical energy or vibration with the use of a magnetic coil, which is attached to vibrating piece like nickel and Terfenol-D. The second is piezoelectric technique, the electrical energy is converted to high frequency electric energy with piezoelectric crystals attached to the vibrating piece (sonotrode, probe or horn).



## ULTRASONIC DEVICES

Most modern ultrasonic devices rely on piezoelectric materials transducers. These materials react with a small change in size to the application of an electric potential on opposite sides. That is the opposite of the piezoelectric effect. The crystal translates electrical energy into mechanical vibration (sound) energy when it alternates at high frequencies. High frequency sound (ultrasound) is produced at sufficiently high alternating potential. A lower frequency ultrasound can cause chemical changes for a system as a result of acoustically induced cavity. Ultrasound (US) wave application with or above a frequency of 20,000 Hz called “sonication”. This frequency is above the sonic range (20 Hz to 20 kHz) at which humans can listen and below the mega-sonic zone (>600 kHz). The motion of the molecules in the setting in which the wave spreads is transmitted energy by US waves. Ultrasound has ranges of approximately 10 to 10 cm in successive waves of compression.

## ULTRASOUND FORCES

Exposing liquids to high mechanical pressure waves (or sound waves), forces as acoustical streaming, stable cavitation and transient (unstable or inertial) cavitation can be induced.

For example, ultrasonic disintegration, sonochemistry and sonoluminescence arises from acoustic cavitation: the formation, growth, and implosive collapse of bubbles in a liquid. Cavitation collapse produces intense local heating (~5000 K), high pressures (~1000 atm), and enormous heating and cooling rates (>10<sup>9</sup> K/sec). Acoustic cavitation provides a unique interaction of energy and matter, and ultrasonic irradiation of liquids causes high energy chemical reactions to occur, often accompanied by the emission of light.

This can only be achieved in specific situation involving specific frequencies of high ultrasound power (high W•cm<sup>-2</sup>, high dB) exposed to relatively low liquid volumes of relatively low temperatures.

## DESIGN ANALYSYS OF ACOUSTIC WAVE SEPARATION APPARATUS

### ACOUSTOPHORETIC SEPARATOR

An acoustophoretic separator can be created in some implementations using a piezoelectric acoustic transducer and an opposing reflection Surface (or a second transducer) to set up a resonant standing wave in the fluid of interest. The ultrasonic standing waves create localized regions of high and low pressure, corresponding to high and low density of the fluid. Secondary phase contaminants are pushed to the standing wave nodes or antinodes depending on their compressibility and density relative to the surrounding fluid. Particles of higher density and compressibility (e.g., bacterial spores) move to the nodes in the standing waves while secondary phases of lower density (such as oils) move to the antinodes. The force exerted on the particles also depends on their size, with larger particles experiencing larger forces.

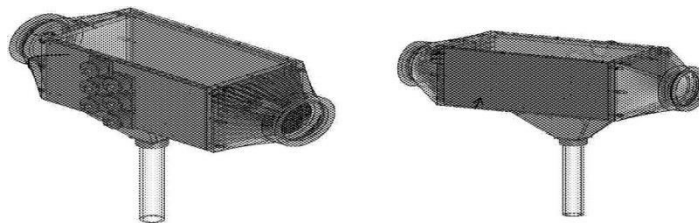

Figure(4) : - shows a schematic showing an apparatus that includes showing flow channels, acoustic transducer, reflective Surface, and a collection pocket, for the harvesting of microalgae (similar to other microorganisms) and/or dirt particles through acoustophoretic trapping.

Besides microorganisms, the acoustic pressures of the standing wave can also separate low-density droplets and higher density particles, such as metal oxides (in the size range of 0.2 microns to 100 microns).



ACOUSTIC FORCES AND PHASE RELATIONS

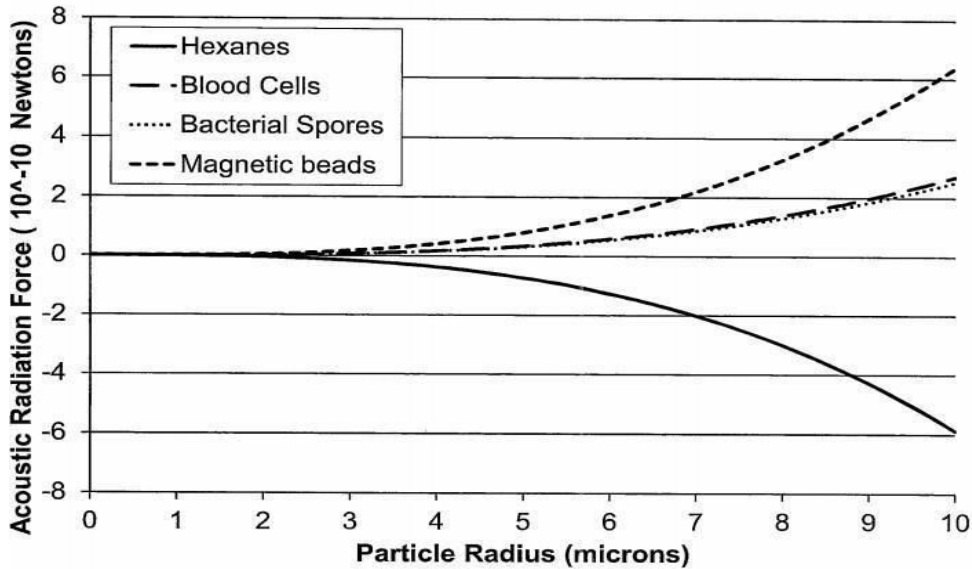

Figure(5): -shows variation of acoustic force that operates on four different secondary phases in water as a function of the particle (or droplet) radius.

The four secondary phases are hexanes (a mixture of hydrocarbons, a model for oils, represented by line at the top of the graph), red blood cells (a model for biological cells) and bacterial spores both of which are represented by the lines in the center of the graph, and paramagnetic poly styrene beads (examples of particles with density and size similar to metal oxide particles represented by the line at the bottom of the graph). The forces for an applied acoustic frequency of 1 MHz (typical for an ultrasonic transducer) and an acoustic pressure of 0.5 MPa maximum at the antinodes (readily achieved in water) are shown in Fig. 2.

For microorganisms in the range of 3-10 microns, the acoustic force can crush/rupture their cell walls. Larger organisms in the range of 10-100 microns can experience organ failure and thus organism death as a result of the acoustic pressure. Achievement of higher applied acoustic frequencies and higher acoustic pressures can afford better separation of smaller metal oxide particles as well as particles of other compositions, for example those on the order of 10 nm in diameter. An ultrasonic transducer operating at a fixed frequency f (HZ) can create an acoustic standing wave in a fluid-filled cavity. The standing wave can be characterized by a local pressure p that is a function of position (X) and time (t),  $P(x, t) = P \cos(kx) \sin(\omega t)$ .

Where, P is the amplitude of the acoustic pressure.

$k =$  wave number (equal to  $2\pi/\lambda$ , where  $\lambda$  is the wavelength), and

$\omega = 2\pi f$ , where  $\omega$  is the angular frequency.

The pressure of the acoustic wave produces an acoustic radiation force F on secondary-phase elements according

$$F_{ac} = X \pi R_p^3 k \frac{P^2}{\rho_f c_f^2} \sin(2kx),$$

to





where R is the particle radius, p, is the density of the fluid medium, c, is the speed of sound in the fluid, and X is the

$$F_{ac} = X\pi R_p^3 k \frac{P^2}{\rho_f c_f^2} \sin(2kx),$$

acoustic contrast factor, defined by

$$X = \frac{1}{3} \left[ \frac{5\Lambda - 2}{1 + 2\Lambda} - \frac{1}{\sigma^2 \Lambda} \right]$$

where A is the ratio of the particle density to fluid density and σ is the ratio of the speed of sound in the particle to the sound speed in the fluid.

The acoustic radiation force acts in the direction of the acoustic field and is proportional to the product of acoustic pressure and acoustic pressure gradient. An inspection of the acoustic radiation force shows that it is proportional to the particle Volume, frequency (or wavenumber), the acoustic energy density (or the square of the acoustic pressure amplitude), and the acoustic contrast factor. The spatial dependency has twice the periodicity of the acoustic field. The acoustic radiation force is thus a function of two mechanical properties: density and compressibility.

**PHASE CONCENTRATION WITH FREQUENCY**

The implementation that can be used to concentrate and separate microorganisms from water, a flow channel can be used to direct flow of fluid dispersion, typically water and a secondary- phase component that is dispersed in the water.

The secondary-phase component in one example can include microorganisms of interest, such as for example Giardia (6-10 microns), Cryptosporium (4-7 microns) Trematodes (egg and larval stages are microscopic), Leptospira (6-20 microns), and Salmonella (0.7-1.5 microns). A microorganism of interest can have an average diameter between 0.5 ,0.20, 10 and 100 microns. An ultrasonic transducer, which in some implementations can be a piezoelectric transducer, can be located in the wall of the flow channel. The transducer can be driven by an oscillating Voltage that has an oscillation at an ultrasonic frequency that can in Some implementations be in a range of several Megahertz.

Figure (6): - Acoustic band formation

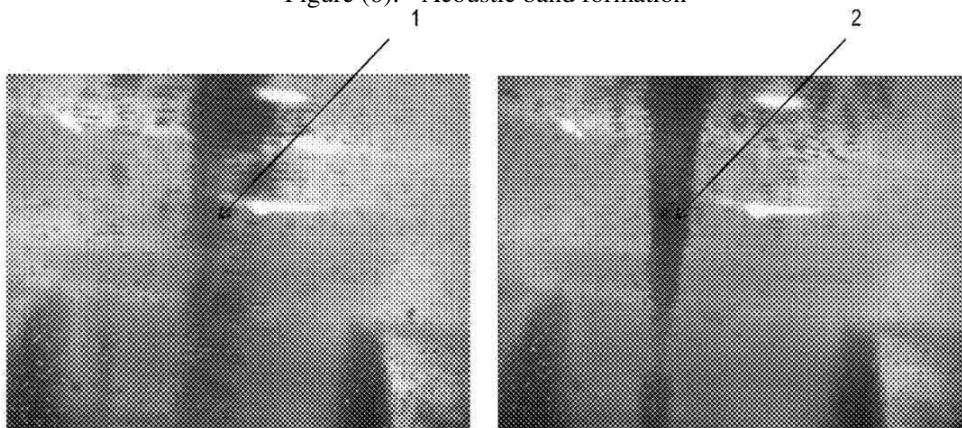

The Voltage amplitude can be between 1 and 100 volts. The transducer, in combination with an acoustic reflection surface located at the wall of the flow tube opposite to the transducer, can generate an acoustic standing wave across the flow channel. Typical pressure amplitudes in the region of the acoustic standing wave or field can be on the order of 0.5 MPa. Such amplitudes are readily available with piezoelectric transducers. This pressure can be high enough to crush and destroy organisms above 10 microns.

Fig.3 is a set of photographs showing acoustophoretic collection of algae (similar size, density and Young's Modulus as microorganisms such as Giardia and Cryptosporium) in a flowing water stream. The radial component



acts to hold the captured microorganisms in a column 1, 2 against the fluid flow. The trapped microorganisms or particles can then be further concentrated by gravitational settling or by being driven to a collector pocket through a slow frequency sweeping method. The collection pocket does not have to be planar, it can also be shaped, conical, curved or spherical. The ultrasonic pressure nodes can be seen as the horizontal planes in which the algal cells are captured. The water flow is from left to right. *D. salina* is the same size/ density range as many pathogens.

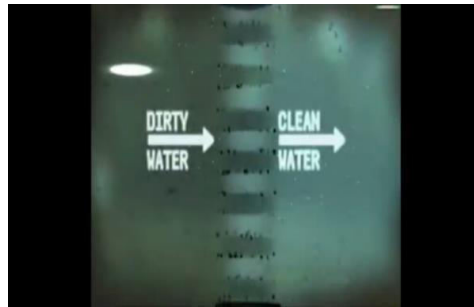

Figure (7): - Impurities in the water as when flows through the standing wave particle bands are formed

#### ACOUCTIC STREAMING IN WATER

The pressure amplitudes for this acoustophoresis process can, in Some implementations, advantageously be maintained below the cavitation threshold values so that a high intensity standing wave field can be created without generation of cavitation effect or significant acoustic streaming.

#### ACOUSTIC STREAMING

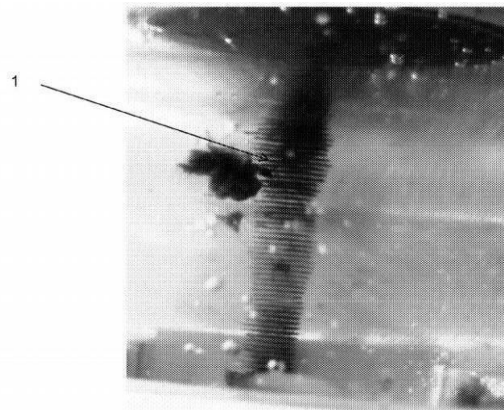

Figure (8)-Acoustic Streaming Process

Acoustic streaming refers to a time-averaged flow of the water produced by the Sound field. Typically, when acoustic streaming is generated, it results in circulatory motion that can cause stirring in the water. Cavitation typically occurs when there are gas bodies, such as air microbubbles, present in the water. The effect of the sound pressure is to create microbubble oscillations which lead to microstreaming and radiation forces. Micro-streaming around bubbles lead to shearing flow in the Surrounding liquid. This flow contains significant Velocity gradients. If a microorganism is located in this shearing flow, the uneven distribution of forces on the cell walls can lead to significant shear stresses exerted on the cell walls that may lead to cell wall disruption and rupture.



### EFFECT OF PRESSURE

At higher Sound intensity levels, the microbubble oscillations can become more intense, and the bubble can collapse leading to shock wave generation and free radical production. This is termed as inertial cavitation. Following a region of the flow path where cavitation is induced, acoustophoresis as described here in can be used to agglomerate Suspended material and also to cause damage to Smaller Suspended pathogens that might not be affected by the larger scale forces of a cavitation environment. The acoustophoretic force created by the acoustic standing wave on the secondary phase component, for example (microorganisms or particles), can be sufficient to overcome the fluid drag force exerted by the moving fluid on these particles. In other words, the acoustophoretic force can act as a mechanism that traps the microorganisms in the acoustic field. The acoustophoretic force can drive microorganisms and Suspended particles to the stable locations of minimum acoustophoretic force amplitudes.

Step 1: Standing wave created by a transducer and reflector.

Step 2: Particles are trapped by the acoustic radiation force.

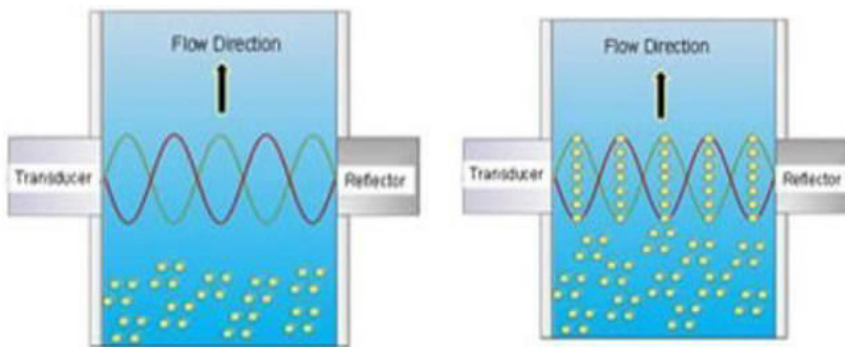

Step 3: Particles clamp within the standing wave

Step 4: Particles reach critical volume and reach out

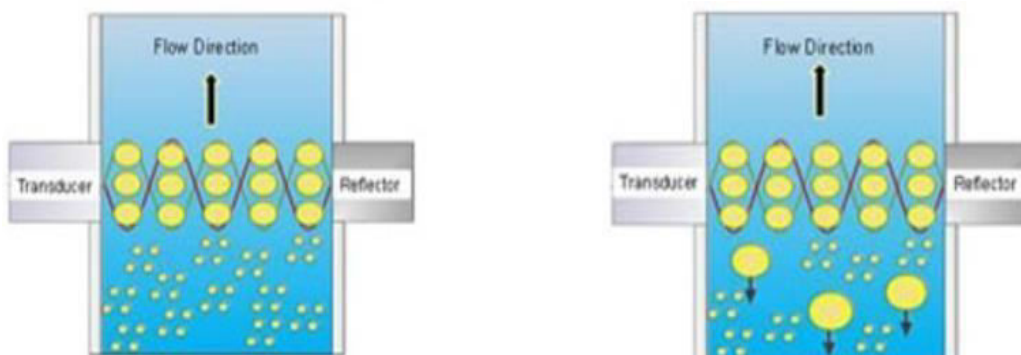



These locations of minimum acoustophoretic force amplitudes can be the nodes of a standing acoustic wave. Over a period of time, the collection of microorganisms at the nodes grows steadily. Within some period of time, which can be minutes or less depending on the concentration of the secondary phase component, the collection of microorganisms can assume the shape of a beam-like collection of microorganisms with disk-shaped collections of microorganisms. Each disk can be spaced by a half wavelength of the acoustic field. The beam of disk-shaped collections of microorganisms can be 'stacked' between the transducer and the opposing, acoustically reflective flow-tube wall. In this manner, acoustophoretic forces can trap and concentrate microorganisms in the region of the acoustic field while the host medium continues to flow past the concentrated microorganisms.

### SWEEPING

If the microorganisms are less dense than the host fluid, the concentrated microorganisms will gain buoyancy and float. For vertical or horizontal flow of the host medium, a slow frequency Sweeping method can be used to translate the microorganisms into collector pockets. In this method, the frequency of the acoustic standing wave can be slowly swept over a small frequency range spanning at least a range of two times the frequency corresponding to the lowest order standing wave mode of the cavity. The Sweep period can be, in one example, on the order of one second. This frequency Sweeping method can slowly translate the collected microorganisms in the direction of the acoustic field towards one of the walls of the flow chamber where the microorganism can be collected for further processing. This sweep is illustrated in Figure (10).

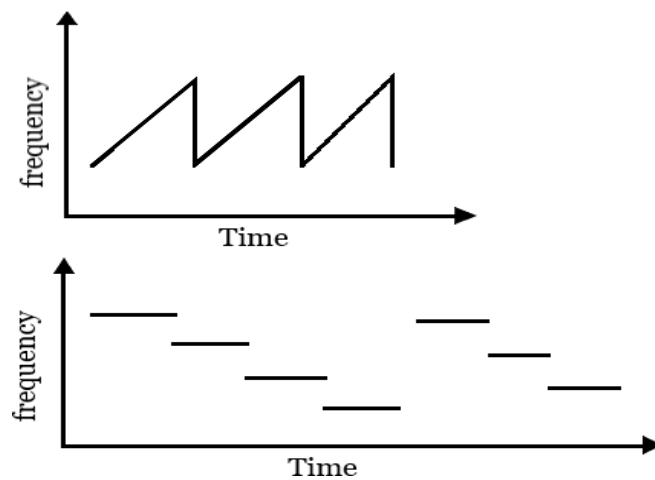

Figure (10) Time frequency sweep relation

### EFFECT OF VARING VOLTAGE

In an alternative implementation, the piezoelectric transducer can be driven by a pulsed Voltage signal that includes,

- short duration,
- large duration,
- positive-amplitude Voltage spikes,
- followed by a longer duration of no applied Voltage signal.

This pulsed pattern can be repeated according to a repetition rate or period. This excitation can generate very large amplitude compressive pressure pulses in water that can be sufficient to rupture the cell walls and cellular membranes of microorganisms prior to acoustophoresis collection.



In another implementation, a piezoelectric transducer can be driven by a pulsed Voltage signal that includes,

- short duration,
- large,
- negative-amplitude Voltage spikes,
- followed by a longer duration of no applied Voltage signal.

This pulsed pattern can be repeated according to a repetition rate or period. This excitation can generate very large amplitude expansion-type pressure pulses in water that can be sufficient to rupture the cell walls and cellular membranes of microorganisms prior to acoustophoresis collection.

The current Subject matter can provide large-scale acoustophoretic technology to collect and process microorganism contaminated water to reduce or eliminate pathogens in the water. In an implementation, this effect can be accomplished using a simple one-step process involving acoustophoresis which simultaneously ruptures large (>10 micron) organisms and collects smaller organisms.

## II. METHODOLOGY

### WORKING OF AWS

A System shown in fig. 2 for concentrating and separating microorganisms from a host medium such as water can include a flow chamber with an inlet 01 and outlet 02. The flow direction can in some variations be oriented in a horizontal direction. The flow chamber can receive a mixture of water including a suspended phase that can include microorganisms, such as microalgae, yeast, fungi, bacteria, or spores as well as other, non-biological particles (e.g., metal oxides, clay, dirt, etc.). The flow chamber can have macro-scale dimensions. In other words, the dimensions of the cross-section of the flow chamber are much larger than the wavelength corresponding to the generated Sound. The system also includes an ultrasonic transducer, that can be embedded in a wall of the flow chamber or located outside of the flow chamber. The ultra-Sonic transducer can include a piezo-electric material and can be driven by an oscillating Voltage signal of ultrasonic frequencies.

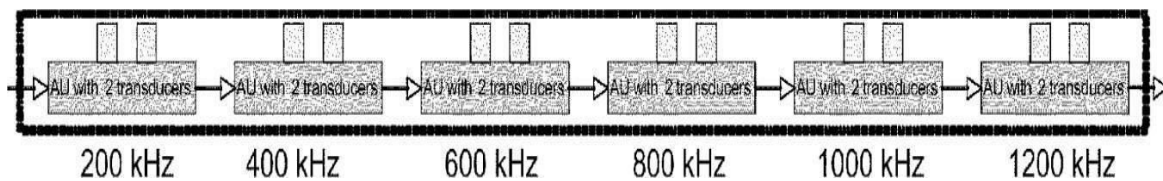

Figure (11)- Number of transducers producing a range of frequencies.

Ultrasonic transducers other than piezoelectric transducers can be used. The ultrasonic frequencies can be in the range from 1 kHz to 100 MHz, with amplitudes of 1-100 of volts, normally acting in the tens of Volts. The ultrasonic frequencies can be between 200 kHz and 3 MHz, 1 and 3 MHz, and can be 200, 400, 800, 1000 or 1200 kHz. The ultrasonic frequencies can also be between 1 and 5 MHz A reflector can be located opposite to the transducer, such that an acoustic standing wave is generated in the host medium.

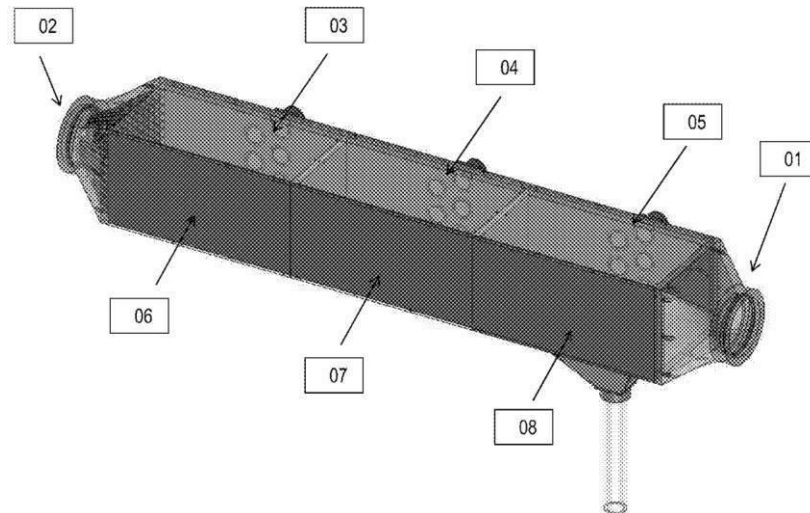

Figure (12)- shows a schematic with three transducers 03, 04, 05 on the wall of a flow chamber with an inlet 02 and an outlet 01. Each transducer has a corresponding reflector 06, 07, 08 on the opposite wall of the flow chamber.

The acoustic standing wave can be oriented perpendicularly to the direction of the mean flow in the flow channel. In some implementations, the acoustic standing wave can be oriented vertically for a horizontal fluid flow direction. The acoustic field exerts an acoustic radiation force, which can be referred to as an acoustophoretic force, on the Suspended phase component. The Suspended phase can be trapped in the acoustic field against the fluid drag force, thereby resulting in large scale collection of the Suspended phase component. Switching off the water flow through the flow chamber can result in gravitational settling of the collected particles to the bottom of the flow chamber.



Figure (13)- Particles being suspended an account of acoustic forces.

In optional variations, the system can be driven at a constant frequency of excitation and/or with a frequency Sweep pattern or step pattern. The effect of the frequency Sweeping, or stepping can be to translate the collected particles along the direction of the acoustic standing wave to either the transducer face or to the opposite reflector face. A collection pocket can be positioned opposite to the transducer, such that settled particles are collected in the collection pocket as shown fig. 2. The collection pocket can include one or more butterfly valves or other mechanisms for removing a slurry containing water with a high Suspended phase concentration from the flow chamber. In this manner, after the suspended phase settles into the collection pocket, the settled Suspended materials are removed from the flowing water Stream.  
inpainted.



### III. CONCLUSION

Acoustics wave technology could be the way to catching and isolating substrates from water without channels, filters, or synthetic substances. There is great interest and need for water purification for developing countries. Depending upon their relative density contrasted with the fluid those large clusters either settle to the base or ascend to the surface, where they can be isolated without any problem. The current subject matter provides, among other possible advantages, a solid-state, low-cost alternative to filter cartridges and filter membranes that is capable of processing large quantities of a host medium, for example water, that is laden with microorganisms or other suspended particles.

The energy will become more expensive in the future, so using large treatment plants will be more expensive by the use of large pumps and motors in the plant. The government will probably rise the wastewater treatment costs for the citizens. Another problem that will occur in the future is space. The population and the wastewater production. There will be built more houses and apartments and there will be less space for treatment plants. Building large treatment plants between the houses is not an option because people do not like the view and the noise of a large plant.

There are two reasons which confirm that the usage of treatment plants is not that good in the future. But there will not be a future without treatment plants because we simply need them. We cannot place individual treatment facilities in cities for every family, house or apartment because there is no space to install the facilities. But the quantity and size of plants can be decreased in the future if more villagers take an individual system, the size of a plant can hereby be decreased and there will also be less energy consumption of the plant.

### REFERENCES

1. "FloDesign Sonics", white house water summit march 22, in press.
2. Gorkov, L. P.; Soviet Physics- Doklady, 1962.
3. Nilsson, Andreas; Petersson, Filip; Jönsson, Henrik; Laurell, Thomas (2004). "Acoustic control of suspended particles in micro fluidic chips". Lab Chip. Royal Society of Chemistry (RSC).
4. Andrade, Marco A. B.; Pérez, Nicolás; Adamowski, Julio C. (2018-04-01). "Review of Progress in Acoustic Levitation". Brazilian Journal of Physics.
5. "Ultrasonic Levitation". 2006-11-04. Archived from [the original](#) on 2006-11-04.
6. Akira Hirose and Karl E. Lonngren, "Fundamentals of Wave Phenomena", 2nd Ed., (SciTech Publishing, 2010).
7. Hawkes, J. J.; Coakley, W. T. "Sens. Actuators", B: Chem. 2001.
8. Lilliehorn, T.; Simu, U.; Nilsson, M.; Almqvist, M.; Stepinski, T.; Laurell, T.; Nilsson, J.; Johansson, S. "Ultrasonics 2005".
9. Bazou, D.; Kuznetsova, A.; Coakley, W. T. "Ultrasound Med. Biol". 2005.
10. Johnson, D. A.; Feke, D. L. Sep. Technol. 1995.
11. "Analytical Chemistry", Vol.79, No.14, July 15, 2007.
12. B. Lipkens, J. Dionne, M. Costolo, and E. Rietman, "Frequency Sweeping and fluid flow effects on particle trajectories in ultrasonic standing waves." Acoustics 08, Paris, Jun. 29-Jul. 4, 2008.
13. B. Lipkens, M. Costolo, and E. Rietman, "The effect of frequency Sweeping and fluid flow on particle trajectories in ultrasonic standing waves", IEEE Sensors Journal, vol. 8, No. 6, pp. 667-677, 2008.
14. Andrade, M. A., Pérez, N. & Adamowski, J. C. Review of Progress in Acoustic Levitation. "Brazilian Journal of Physics". 48(2), 190–213 (2018).
15. Leong, T., Johansson, L., Juliano, P., McArthur, S. L. & Manasseh, R. Ultrasonic separation of particulate fluids in small- and large-scale systems: a review. Industrial & Engineering Chemistry Research. 52(47), 16555–16576 (2013).
16. Cappon, H. J. Numerical and experimental design of ultrasonic particle filters for water treatment. PhD Thesis. (Wageningen University, 2014).
17. Lindahl TL, Ramstrom S. 'Methods for evaluation of platelet function'. Transfus Apher Sci 2009;41(2):121–125.
18. Y.-G. Kim, S. Moon, D. R. Kuritzkes and U. Demirci, *Biosens. Bioelectron.*, 2009, **25**, 253–258 .
19. G. D. Chen, C. J. Alberts, W. Rodriguez and M. Toner, *Anal. Chem.*, 2010, **82**, 723–728 .
20. P. Dussart, B. Labeau, G. Lagathu, P. Louis, M. R. T. Nunes, S. G. Rodrigues, C. Storck-Herrmann, R. Cesaire, J. Morvan, M. Flamand and L. Baril, *Clin. Vaccine Immunol.*, 2006, **13**, 1185–1189 .
21. H. Schulze, G. Giraud, J. Crain and T. T. Bachmann, *J. Biophotonics*, 2009, **2**, 199–211 .



22. X. Cheng, G. Chen and W. R. Rodriguez, *Anal. Bioanal. Chem.*, 2009, **393**, 487–501 .
23. M. Smit, K. A. Beynon, D. R. Murdoch and L. C. Jennings, *Diagn. Microbiol. Infect. Dis.*, 2007, **57**, 67–70 .
24. C. DeLima, J. Blair, D. E. Low, L. Burton, T. Mazzulli and S. J. Drews, *Int. J. Infect. Dis.*, 2009, **13**, e327–E328 .
25. T. P. Leary, R. A. Gutierrez, A. S. Muerhoff, L. G. Birkenmeyer, S. M. Desai and G. J. Dawson, *J. Med. Virol.*, 2006, **78**, 1436–1440 .





**INNO SPACE**  
SJIF Scientific Journal Impact Factor  
**Impact Factor: 8.118**



**ISSN** INTERNATIONAL  
STANDARD  
SERIAL  
NUMBER  
INDIA



# INTERNATIONAL JOURNAL OF INNOVATIVE RESEARCH

IN SCIENCE | ENGINEERING | TECHNOLOGY

 **9940 572 462**  **6381 907 438**  **ijirset@gmail.com**



[www.ijirset.com](http://www.ijirset.com)

Scan to save the contact details