



e-ISSN: 2319-8753 | p-ISSN: 2347-6710

IJIRSET

International Journal of Innovative Research in
SCIENCE | ENGINEERING | TECHNOLOGY

INTERNATIONAL JOURNAL OF INNOVATIVE RESEARCH

IN SCIENCE | ENGINEERING | TECHNOLOGY

Volume 12, Issue 4, April 2023

ISSN INTERNATIONAL
STANDARD
SERIAL
NUMBER
INDIA

Impact Factor: 8.423

9940 572 462

6381 907 438

ijirset@gmail.com

www.ijirset.com



Structural Health Monitoring Based on Vibration Approach

Prof. Sogarwal A. M. ¹, Aditya Padul ², Nakul Phulewade ³, Paranjale kale ⁴, Mahadev Dhakane ⁵,
Piyush Dandge ⁶, Karan Narawade ⁷.

Assistant Professor, Department of Civil Engineering, School of Engineering and Technology, MGM University,
Chhatrapati Sambhajanagar, Maharashtra, India ¹

Diploma Students, Department of Civil Engineering, MGM's Polytechnic, Chhatrapati Sambhajanagar,
Maharashtra, India. ^{2,3,4,5,6,7}

ABSTRACT: Structures can be common or distinctive, and they're an important element that's directly connected to both living and non-living effects. An internal weakness can sometimes affect the entire body of a structure, leading to its collapse and ruinous loss of life and property. Increased knowledge of structural health monitoring ways (SHM) latterly offers ideas and results for the concerned defeat discovery, but extreme and worst structure damage prompts the development of new technologies for the recognition of new structural health monitoring ways as a damage discovery tool. offers status monitoring, fault opinion, vibration control, and fractures identification using vibration analysis. Using ongoing monitoring systems after system perpetration offers the following advantages. The cost of the structure's entire life will be by 10 if the streamlined continuance vaticination models are used from the design stage on. Wireless integrated detectors now reuse real- time raw detector signal data into target measures, similar as relegation, and shoot the results through a standard protocol to the waiters on the Internet. The covered data is farther reused on the waiters for visualization purposes, and the reckoned results are transferred to connected guests in real- time through cybersurfs or mobile operations.

KEYWORDS: SHM, cracks detection, vibration diagnosis, structure, IOT.

I. INTRODUCTION

ImageFor crucial structures like bridges, wind turbines, and tunnels, structural health monitoring (SHM) is the process of applying damage detection and characterization tools. It uses a variety of embedded or connected sensors to the structure as a non-destructive in-situ structural assessment approach. The process of monitoring the safety, strength, integrity, and performance of the structure involves installing sensors, data collecting, data transfer, and diagnostics. Snice the beginning of the 19th century, railroad wheel- trappers have used the sound of hammer striking the train wheel to evaluate if damage was present, in rotating machinery, vibration monitoring has been used for decades as a performance evolutional technique in the field of SHM are wave propagation-based techniques vibration-based techniques. The available localized experimental methods being used include acoustic emission or ultrasonic method, electro-magnetic field methods, x-ray, radiographs, eddy current methods, and thermal field methods, based on the amount of information provided regarding the damage state, this method can be classified as providing. Management of IOT ideas helps to monitor the process from someone the experience. Individual needs not to perhaps be live presently to visualize the process. Masters have labelled SHM all at once of the top ten electronics bearing the potential of forceful the all-encompassing saving HM, particularly for big obliging constructions, needs a monumental network of sensors delivered throughout the construction. This has catalysed research works to investigate the likelihood of engaging renewable energy beginnings to capacity the sensors distributed throughout the structure. The use of vibration to be a part of generators for adapting the vibrational strength of buildings into energetic strength is individual aforementioned likelihood being investigated precisely over the last three decades. Vibration sensors patches, operating in ESP32, are deliberate best for SHM. The main aim of this thesis is to explore the potential of employing the vibration sensor, operating in ESP32 (MCU), for SHM as well as energy analysis the structure on real-life structures.1 Four levels of damage detection.2. Determine the location of damage.4. Determine the remining useful life of the structure. To analyze the performance of structural components in fixed time intervals.2. Dynamic monitoring systems have proven to be particularly suited for systems whose structural conduct are explosively affected by their geometric



difficulty or the inhomogeneity of their constituent accoutrements 3. Very well engineered, durable, and stable sensor technologies are available, this technology can easily be implemented. Maintaining safe and non-viable civil infrastructure for daily use is important to the well-being of all of us. Knowing the integrity of the structure in terms of its age and operation, and its level of safety to withstand infrequent but high forces such as overweight trucks, earthquakes, tsunamis, and hurricanes is important and necessary. Determining and tracking structural integrity and relating the nature of damage in a structure is frequently ascertained to as health monitoring. In damage detection sector, different kind of research and innovation has been developed. In older time people exercised to detect the disfigurement on the structure or in any body by visual examination and also by hitting the body with hammer and by the sound disparity they exercised to read the unhealthy part or fault inside the body or structure. In swirling ministry, vibration monitoring has been exercised for decades as an interpretation evaluation fashion. Wired techniques are mostly useful for the bodies which are small and in which the structure is physically in touch with the sensors whereas in wireless technique, the sensors are not in physically in touch with the structure. The several techniques give new and precious methods for the damage detection. Structural health monitoring system is an approach of valuating and watching the health of overcritical structures. It has been assumed for numerous important designs because of its capability to respond to mischievous structural changes, enhancing structural trust ability, and helping life round guidance. Structural health monitoring provides a tool to ensure structural integrity and safety, detecting the growth of damages, and evaluating the performance of infrastructures. Structural health monitoring has been developed and exercised for nonidentical structures like soil, structures, coverts, control factories, and heads. Structural Health Monitoring (SHM) provides the installations for in-indulgence monitoring of structural interpretation and damage valuation, and is a critical component of condition- grounded conservation and damage prognostic. creations in the structural health monitoring technologies applied to civil engineering structures. It covers all aspects needed for similar monitoring in the field, involving detectors and networks, data accession and processing, damage discovery ways and damage prophecies ways. developed based on IoT sensor devices and cloud computing in the real-time fashion. Our SHM system visualizes real-time dynamic structural actions in 3D model through trap or mobile so druggies can fluently understand and observe the exclusive structural motions. Since detectors at their installation locales measure the structural three-dimensional relegation, how to show off exclusive structural metamorphosis on 3D model at every exposition time interlude depends on converting the original relegation data form its rudiments into common motion in global match system. Hence, we result the turned over motion arithmetic system to affair the 3D structure motion.

II. OBJECTIVE OF WORK

1. The main ideal of the structural health monitors the integrity of structures and descry and pinpoint the locales of possible damages. The placement of detectors during construction works enables the spectators to assess the structure's condition and specify its remaining life span.
2. The estimation of the structure's remaining continuance ensures timely form or the extension of life- expectation through fatigue monitoring. The conservation robotization, meaning a reduction of time-out, requires lower outfit and capital investment.
3. To learn from gests to ameliorate practices and conditioning in the future to have internal and external responsibility of the coffers used and the results attained to take informed opinions on the future of the action promote commission of heirs of the action.
4. The effect of losses similar as the mechanical loss, the dielectric loss and the shear pause loss and to extend the logical model to real- life structures.
5. To performing detailed parametric studies to work out the optimum size and parameters of the patches from energy harvesting considerations.

III. LITERATURE REVIEW

The various literature has been referred from journals, proceedings, website etc. to understand the present status of project undertaken. From the literature, data is summarized from work. This are explained in following way.

Jiawei et al. (2021) [1] Recently, SHM is applied not is civil infrastructure aspect, but it is also applied in buildings and aircraft maintenance and many other aspects, which is fundamentally used in our daily life.

But, as it is becoming more and more significant in structural health, we are on an urge to apply it in more different field, and a valuable attempt is found to bear in archaeological field.

Fritzen et al. (2005) [2] This paper gives an overview on the current status of vibration-based methods for structural health monitoring. All these methods have in common that a structural change due a damage result in a more or less



pronounced change of the dynamic behaviour. The use of modal information is discussed, as well as the direct use of forced and ambient vibrations.

Chang et al. (2018) [3] Real-time monitoring on various structural behaviours, particularly displacement and acceleration, serves important and valuable information for people. Monitoring result are further processed for visualization purpose in the servers and the computed results are pushed to connected client like browsers on mobile applications in real-time.

Adhikari et al. (2019) [4] The most fundamental challenge is the fact damage is typically a local phenomenon and may not significantly influence the lower-frequency global response of structures that is typically measured during vibration tests. This challenge is supplemented by many practical issues associated with making accurate and repeatable vibration measurements at a limited number of locations on structures often operating in adverse environments.

IV. METHODOLOGY

By utilizing substitution interfacing gadgets and cloud stages for investigation and control, wired association complexity may be decreased in a modest step toward making smart businesses. By swapping out auxiliary complexity with consistent gadgets and cutting-edge communication gadgets, this moreover addresses the issue of complicated equipment engineering. In arrange to construct an obstruction, this consider will utilize computational methods. Resources are right now a major issue in numerous small- and medium-sized undertakings. Computerization could be an exceedingly successful and productive way to introduce greatly high-configured gear, which may be an issue in little and medium-sized businesses.

Targets are characterized by the market's consistent development, but a deficiency of assets has developed as a potential deterrent in numerous ways. Consider, for case, a mushroom collecting office where the larger part of the strategies is manual, the fabricating prepare endures at slightest 14 weeks, and the surrender is decided by these components. A conveyor framework might speed up the method of moving create whereas keeping up a reliable environment and basic taking care of. Numerous other businesses that depend on people for the method still have the issue. This article offers a brief overview of potential benefits of IOT within the computerization trade, with the objective of maintaining a strategic distance from issues with human mistake and maximizing the utilize of all labour for moved forward yield. The common experiences secured in this article with real-time deployment incorporate beginning the method, telling metal from nonmetal, and treating the component agreeing to prerequisites. An enormous arrange of sensors spread out all through the structure is essential for SHM, particularly for major respectful projects. The issue of fulfilling these sensors is crucial. Structures are screened utilizing local-based damage detection, though vibrational properties are screened utilizing global-based damage location. In SHM frameworks, a few sensors are utilized to recognize the greatness and area of the damage. Since of their preferences over other sensors, picture location and vibrational sensors are broadly utilized. Since they are delicate to auxiliary changes, sheep waves are considerably more taken a toll viable and tried and true. The key to basic harm localization, in any case of the geometrical or imaging approach utilized, is the obtained time of flight and adequacy of the reaction to the flag.

IOT SHM Network of Intelligent Devices causes the require for building repair. We utilize the cube test, but how distant its relevance is taken under consideration as the assignment advances, and how distant the co-relationship with such results is kept up. Development printed material contain determinations and bearings; in any case, they are some of the times cleared out on paper owing to a need of comprehension. Building and support methods are not taken after or kept up on a normal premise. Buildings that have been dismissed for various a long time. The results of standard cube tests are used to assess building quality. Numerous times, the quality of concrete when it is poured and cemented in put has no association with the cube test discoveries, which are utilized for quality control. Methods for occasional examination of buildings and structures and reporting blemishes, such as splits, over the top avoidances, erosion of support, and so on, in a consistent way, as well as Enrollment of basic repairs already completed, are habitually not taken after, or kept up. In other buildings, as it where visual assessments are performed to plan upkeep budget projections, and this assignment is as often as possible assigned to engineers who have small skill expertise ability mastery skill with such issues. Engineers in charge of building support in some cases start repair work without a careful get a handle on of the reasons causing the flaws. But in this handle, there's a solid plausibility that the source and cause for the trouble stay unattended and proceed to cause issue indeed after the shallow repairs have been executed. Arduino Uno utilizes the foremost well-known ATMEL MCU gadget.

It is favoured for utilization in a few ventures including hardware and inserted frameworks since it is an open-source stage. The program modified, which streams from the computer to the board utilizing IDE, will control a physical circuit with an MCU.

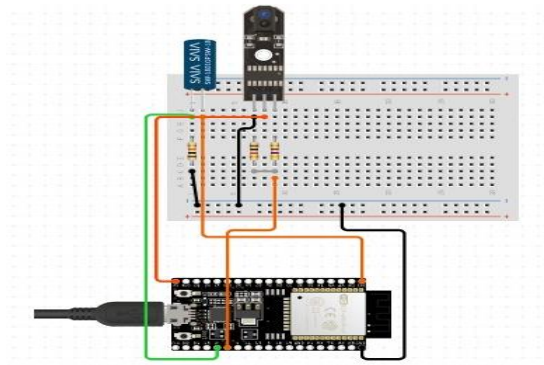

FIG.NO. 1 CIRCUIT DIAGRAM

1 Programming ESP32 with Arduino IDE: STEP 1: Attach your ESP32 board to your computer through the micro-USB string.

STEP 2: Start the Arduino IDE and handle to Tools-> Boards and choose ESP32Dev board as shown below.

STEP 3: Unlock gadget director and check to which com harbourage your ESP32 is attach to.

Mine is connected to COM 8 as shown below STEP 4: Go back to Arduino IDE and under Tools -> Port selects the Port to which your ESP is connected to.

STEP 5: Let`s upload the Blink Program, to check if we are able to program our ESP32 module.

STEP 6: To connect the code, just click on transfer and you should see the Arduino comfort displaying the following if everything works as expected.

1. Instrumentation: The first step in vibration-based SHM is to instrument the structure with sensors to measure its response to dynamic loads. These sensors may include accelerometers, strain gauges, or displacement transducers. The location and number of sensors will depend on the size and complexity of the structure, as well as the type of damage being monitored. 2. Data Acquisition: The next step is to collect data from the sensors using a data acquisition system. The data acquisition system should have a high sampling rate and a wide frequency range to capture the dynamic behaviour of the structure accurately. 3. Signal Processing: The collected data is then processed using signal processing techniques to extract features that may indicate damage or degradation. Damage detection methods may involve the comparison of the measured response to a baseline response or a reference model of the structure. Any deviation from the baseline response or the reference model indicates damage or degradation. The benefits of IoT-based structural health monitoring are numerous. By detecting and identifying structural issues early on, this technology can help prevent costly and dangerous failures. Additionally, IoT-based structural health monitoring can improve the safety of infrastructure by identifying potential hazards and allowing for proactive maintenance and repair. Most compelling applications of SHM utilizing Vibration based transducers have included flexural basic columns or possibly outline examples. About all wave-based wellness checking approaches which include piezoelectric based transducers need them to be pre inserted within the structures prior to casting. Investigates of the affectability as well as convenience of post implanted piezoceramic based transducers for any SHM of current concrete buildings are moreover truly basic. With respect to retrofitted RCC members, the interface fiasco or possibly splits between 2 basic clients (one current and one included) are basic conjointly impact the convenience of the retrofit. The essential reason for this specific exertion is creating the post implanted Vibration Sensor transducers that will be utilized to recognize interface disappointment or possibly breaks between 2 basic clients in retrofit development. This specific exertion comprises of a test on the SHM of Structural elements dividers utilizing post inserted transducers. Waterproof post implanted transducers are utilized as sensors and actuators for SHM as well as hurt location all through the cyclic stacking test. For examples underneath cyclic stacking, the post embedded transducers are utilized to recognize break enhancement in as well as the wellbeing condition of, an interface between current as well as retrofitted auxiliary clients. Of the cyclic stacking test, the disseminated post inserted transducers within the concrete buildings are utilized to do SHM. The engendering vitality of the waves is constricted within the nearness of damage or breaks.



Internet of things (IoT) Platform for SHM A technique known as IoT (Internet of Things) based structural health monitoring gathers information on the structural health of buildings, bridges, and other infrastructure using a variety of sensors and devices. The gathered information is then processed and evaluated to reveal the structure's state and any possible problem areas. IoT-based structural health monitoring's major objective is to spot any early warning signals of damage, wear and tear, or other problems, enabling proactive maintenance and repairs.

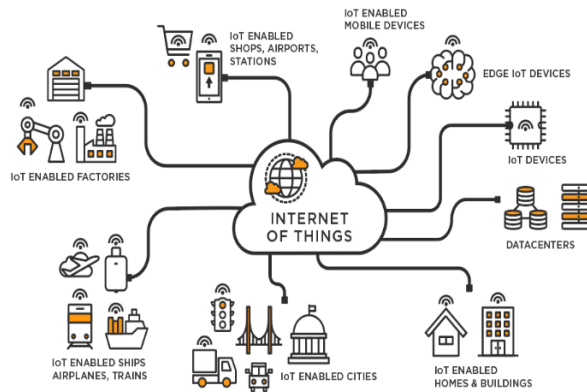

FIG.NO.2 IoT(Internet of thing) Platform for SHM

With the use of this technology, costly and harmful structural breakdowns may be avoided, and infrastructure lifespans can be increased. Typically, sensors that detect different characteristics, such as vibration, strain, temperature, and humidity, are used in IoT-based structural health monitoring. Wirelessly communicated to a central monitoring system, where machine learning techniques are used to evaluate and analysis the data gathered by the sensors. The enhanced lifespan of infrastructure, lower maintenance costs, and greater safety are some advantages of IoT-based structural health monitoring. In general, IoT-based structural health monitoring is a promising technology that might completely change how we keep an eye on and manage our infrastructure. We may anticipate even more advanced and efficient structural health monitoring systems in the future thanks to the ongoing development of sensors, wireless communication technologies, and machine learning algorithms. Utilizing SHM provides prompt structural damage detection, which in turn enables proactive loss prevention actions. The development of SHM has been aided by the rising demand for trustworthy structural health data.

V. EXPERIMENTAL RESULTS

RESULT 1: CUBE AND ITS SIGNATURE GRAPH IN HEALTHY STATE (UNDAMAGED STATE)



FIG.NO.3 UNDAMAGE CUBE



|| Volume 12, Issue 4, April 2023 ||

| DOI:10.15680/IJIRSET.2023.1204287 |

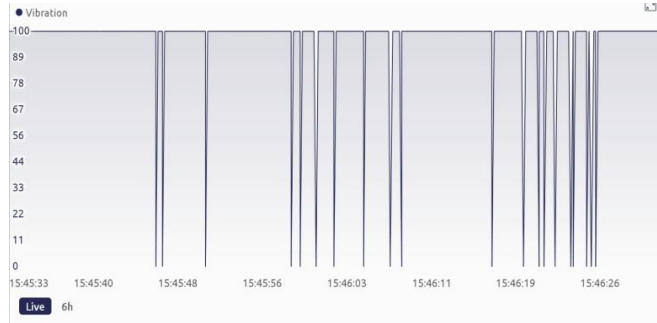

FIG.NO.4 UN DAMAGE CUBE VAIBRATION GRAPH

RESULT 2: CUBE AND ITS SIGNATURE GRAPH IN UNHEALTHY STATE (DAMAGED STATE)



FIG.NO. 5 DAMAGE CUBE

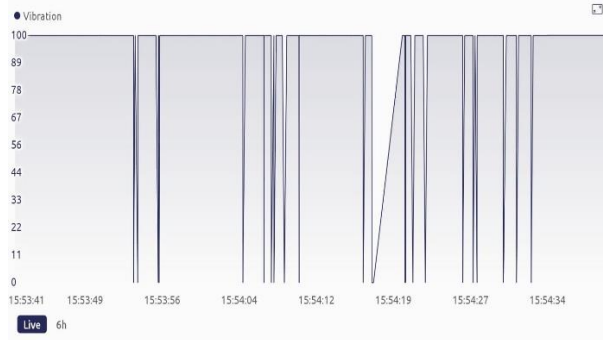

FIG.NO.6 DAMAGE CUBE VIBRATION GRAPH

RESULT 3: COLUMN AND ITS SIGNATURE GRAPH IN HEALTHY STATE (UNDAMAGED STATE)



FIG.NO.7 UN DAMAGED COLUMN.



|| Volume 12, Issue 4, April 2023 ||

| DOI:10.15680/IJIRSET.2023.1204287 |

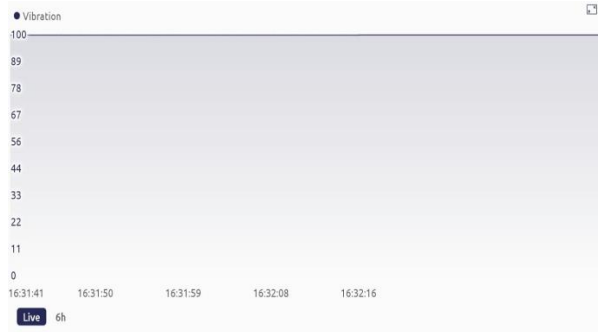

FIG.NO.8 UNDAMAGED COLUMN VIBRATION GRAPH

RESULT 4: LOAD BEARING WALL AND ITS SIGNATURE GRAPH IN UNHEALTHY STATE (DAMAGED STATE)



FIG.NO.9 LOAD BEARING WALL (DAMAGED STATE)

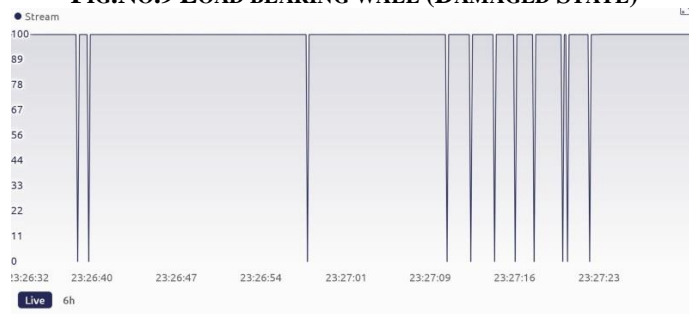

FIG.NO.10 DAMAGED LB WALL VIBRATION GRAPH

RESULT 5: DEMOLISHED STRUCTURE AND ITS SIGNATURE GRAPH IN UNHEALTHY STATE (DAMAGED STATE)



FIG. NO.11 DEMOLISHED STRUCTURE

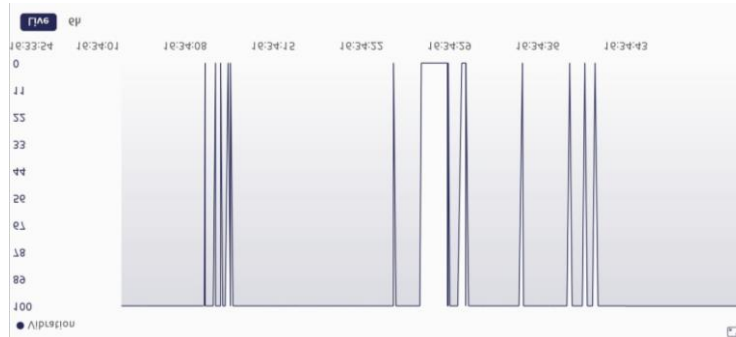

FIG.NO.12 DEMOLISHED STRUCTURE VIBRATION GRAPH

VI. CONCLUSION

In the project work, an IoT system based on Internet of Things with Arduino uno programming model for SHM system based on crack detection vibration will be able to detect any change in the response of the elements. In addition, cracks or interface defects were not noticed during renovations during retrofit.

1. The experimental success of this effort shows that the receiver can be used to recognize errors or interface cracks between structural users in retrofit buildings and help engineers determine the extent to which structural damage after an earthquake.
2. The vibration-based SHM is a powerful tool for monitoring the condition of structures.
3. Using this approach, engineers can detect structural damage or deterioration and take corrective action to prevent serious problems.
4. Typical SHM systems provide monitoring output that can warn when the structure is beyond design capacity or even detect possible failures. For real-time monitoring of structural parameters, implement his IoT-based SHM model described above. The use of artificial intelligence is compatible with SHM's machine learning. You can detect seismic zones in real time using suitable SHM techniques. Applicable for real-time bias monitoring. Suitable for underwater SHM may be used to detect earthquake zones in real time.

REFERENCES

- [1] Varadan, V. K. and Varadan, V. V., 2000. "Microsensors, Microelectro- mechanical Systems (MEMS), and Electronics for Smart Structures and Systems," *Smart Materials and Structures*, Vol. 9, No. 6, 953- 972.
- [2] Brinda Chanv Prof. Sunil Bakhru& Prof. Vijay Mehta Structural health monitoring system using iot and Wireless technologies Dec 22-23, 2017.
- [3] Debajyoti Misra Gautam Das Debaprasad Das an Iot Based Building Health Monitoring System Supported by Cloud, *journal of Reliable Intelligent Environments* 7may 2020.
- [4] Spencer, B. F. Jr., 2003, "Opportunities and Challenges for Smart Sensing Technology," in *Proceedings of the International Conference on Structural Health Monitoring and Intelligent Infrastructure*, Tokyo, Japan, November 13-15, Vol. 1, 65-71.
- [5] Tanner, N. A., Wait, J. R., Farrar, C. R., and Sohn, H., 2003, "Structural Health Monitoring Using Modular Wireless Sensors," *Journal of Intelligent Material Systems and Structures*, Vol. 14, No. 1, 43-56.



SJIF Scientific Journal Impact Factor

Impact Factor: 8.423



INTERNATIONAL JOURNAL OF INNOVATIVE RESEARCH

IN SCIENCE | ENGINEERING | TECHNOLOGY

 9940 572 462  6381 907 438  ijirset@gmail.com



www.ijirset.com

Scan to save the contact details