



e-ISSN: 2319-8753 | p-ISSN: 2347-6710

# IJRSET

International Journal of Innovative Research in  
**SCIENCE | ENGINEERING | TECHNOLOGY**

# INTERNATIONAL JOURNAL OF INNOVATIVE RESEARCH

IN SCIENCE | ENGINEERING | TECHNOLOGY

Volume 12, Issue 4, April 2023

**ISSN** INTERNATIONAL  
STANDARD  
SERIAL  
NUMBER  
INDIA

Impact Factor: 8.423

9940 572 462

6381 907 438

[ijirset@gmail.com](mailto:ijirset@gmail.com)

[www.ijirset.com](http://www.ijirset.com)

# Replacement of Fly Ash & Coconut Fibre with Cement

Atharav D.Khakare<sup>1</sup>, Akash N.Tayade<sup>2</sup>, Prof.Dhiraj G.Wankhede<sup>3</sup>

U.G. Student, Department of Civil Engineering, Siddivinayak Technical Campus, Shegaon, Maharashtra, India<sup>1</sup>

U.G. Student, Department of Civil Engineering, Siddivinayak Technical Campus, Shegaon, Maharashtra, India<sup>2</sup>

Assistant Professor, Department of Civil Engineering, Siddivinayak Technical Campus, Shegaon, Maharashtra, India<sup>3</sup>

**ABSTRACT**When water is added to cement, which is a fine binding ingredient, it sets and becomes stronger. Despite having many benefits and being widely used in construction, cement has a number of drawbacks as well. All stages of the cement manufacturing process have a negative impact on the environment. Pollutant emissions such as those from dust, gas, noise, and vibration are among them. Carbon dioxide, the most prevalent greenhouse gas, is released throughout the cement manufacturing process, ranging from 5% in cement structures to 8% in cement roadways. The production of cement results in the direct and indirect emissions of carbon dioxide (heating of calcium carbonate and energy emissions). Cement manufacturers are responsible for up to 5% of all manmade CO<sub>2</sub> emissions worldwide.

**KEYWORDS:** Cement, flyash, class C-flyash, class F-fly ash, HVFA.

## I. INTRODUCTION

Directly releasing waste into the environment can have negative effects on the environment. The importance of recycling garbage has therefore been highlighted. To use natural resources more effectively and preserve the environment from waste deposits, waste can be used to create new goods or used as admixtures. The natural fertility of the soil is ruined when these industrial wastes are deposited on surrounding property.

## RELATED WORK

General Fly ash is used in the carbonation process to naturally or quickly adsorb CO<sub>2</sub> from the atmosphere. Carbonation of fly ash transforms the calcium oxide it contains into calcium carbonate, which absorbs carbon dioxide and functions as a carbon capture and storage (CCS) technique. Techniques for CCS.

## II. METHODOLOGY

Testing of the Material – 1] Sand, 2] Cement, 3] Course/Fine Aggregate, 4] Initial Setting Time, 5] Final Setting Time.

Cement is a crucial component of concrete, according to the material test. Cement is made by grinding the basic components, mixing them well, and then igniting them in a kiln at a temperature between 13,000° and 15,000°c. Different tests are conducted to assess the different qualities of cement.

Testing on concrete – 1] compression test, 2] flexure test, 3] splittensile strength

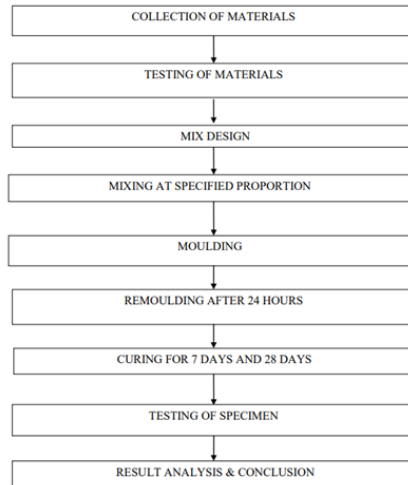

Flow Chart: “Schematic Representation of Methodology”

Mixing Material Fly-Ash & Coconut Fibre.



A] Fly-Ash



B] Coconut Fibre

III. EXPERIMENTAL RESULTS

Quantity Material Requirement							
Materials	Mix 1 (Plain Concrete)	Mix 2 (4% fibre) processed	Mix 3 (5% fibre) Processed	Mix 4 (6% fibre) processed	Mix 5 (4% fibre) Raw	Mix 6 (5% fibre) Raw	Mix 7 (6% fibre) Raw
Cement (Kg)	9.5	9.5	9.5	9.5	9.5	9.5	9.5
Water (Kg)	4.75	4.75	4.75	4.75	4.75	4.75	4.75
Coarse Aggregate (Kg)	27	27	27	27	27	27	27
Fine Aggregate (Kg)	16.5	16.5	16.5	16.5	16.5	16.5	16.5
Fibre (Kg)	-	0.38	0.475	0.57	0.38	0.475	0.57
Super Plasticizer	0.20%	0.40%	0.60%	0.20%	0.40%	0.60%	0.60%

Table No 1:-Quantity Material Requirement

Placing a concrete on mould with proper proportion follow is on Table No 1:-

**Material Sorting in Size:-**



A] Aggregate with size



B] Sand



C] Coconut Fibre



D] Fly-Ash

**Table No 2: - “Material Sizes”**

0 to -1	1-2 mm	Very coarse sand
1 to 0	0.5-1 mm	Coarse sand
2 to 1	0.25-0.5 mm	Medium sand
3 to 2	125-250 µm	Fine sand

In order to partially replace cement, FA is used in concrete. FA comprises small, spherical particles that enhance workability, durability, and long-term strength, making it the ideal pozzolanic material for building concrete, according to study. There is evidence that concrete's tensile strength has increased by 15% to 25%. Greater amounts of FA replacement, however, weaken the tensile strength at ages of 28 and 56 days after curing.

Cement and fine aggregate are combined in the calculated amount until a homogenous mixture is produced. The percentages of fibre used in cement are 4%, 5%, and 6%. Coir fibre strands are cleaned, cut into 5 cm lengths, coated in coconut oil, and let too dry in the sun for 24 hours.



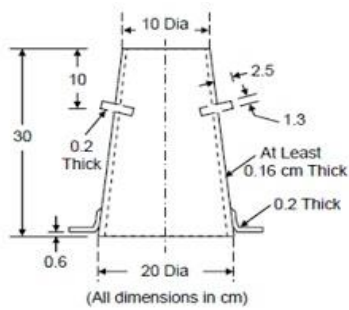

Placing a Concrete on Slump mould with adding of Fly-Ash & Coconut Fibre

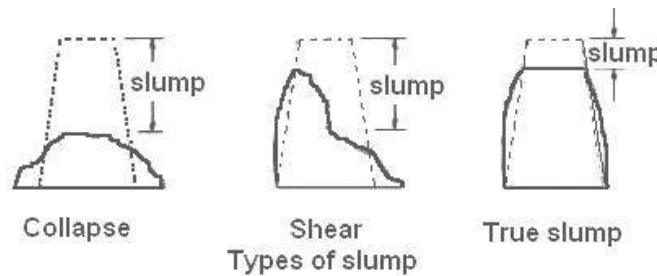
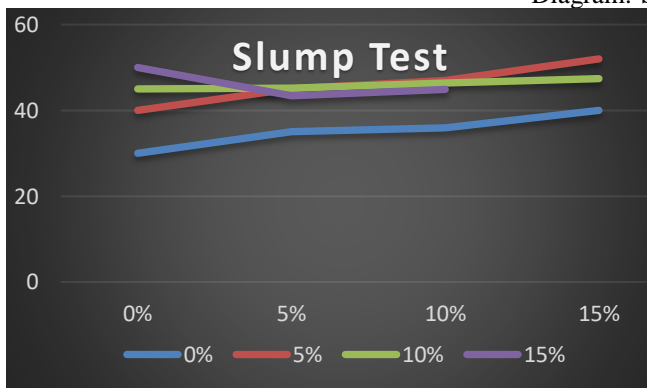
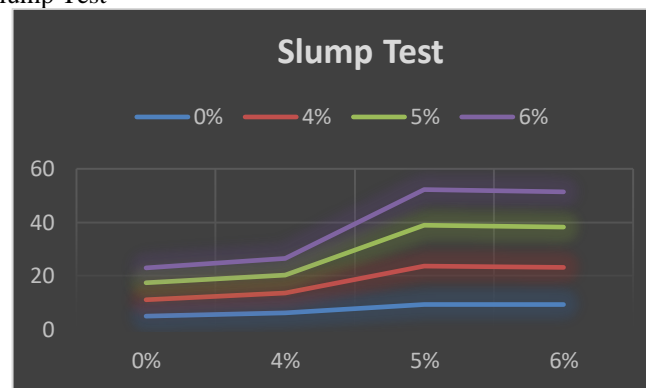

Diagram:-Slump Test



Graph No 1:-Slump Test on (Fly-Ash)



Graph No 2:-Slump Test on (Coconut Fibre)

When fly ash is added to Portland Cement Concrete (PCC), it improves the performance of the concrete in both its fresh and hardened forms and offers a variety of benefits. The addition of fly ash to concrete improves the workability of flexible concrete as well as the strength and durability of hardened concrete. Fly ash use is also cost-effective. If fly ash is utilised, concrete may need less portland cement.

The results of the experimental tests revealed that concrete's hardness and flexural strength were boosted by the addition of coconut fibres. The compressive strength, compressive toughness modulus of rupture (MOR), and flexural total toughness index of CFRC rose to 4%, 21%, 2%, and 910%, respectively, with the addition of 50 mm long fibres.

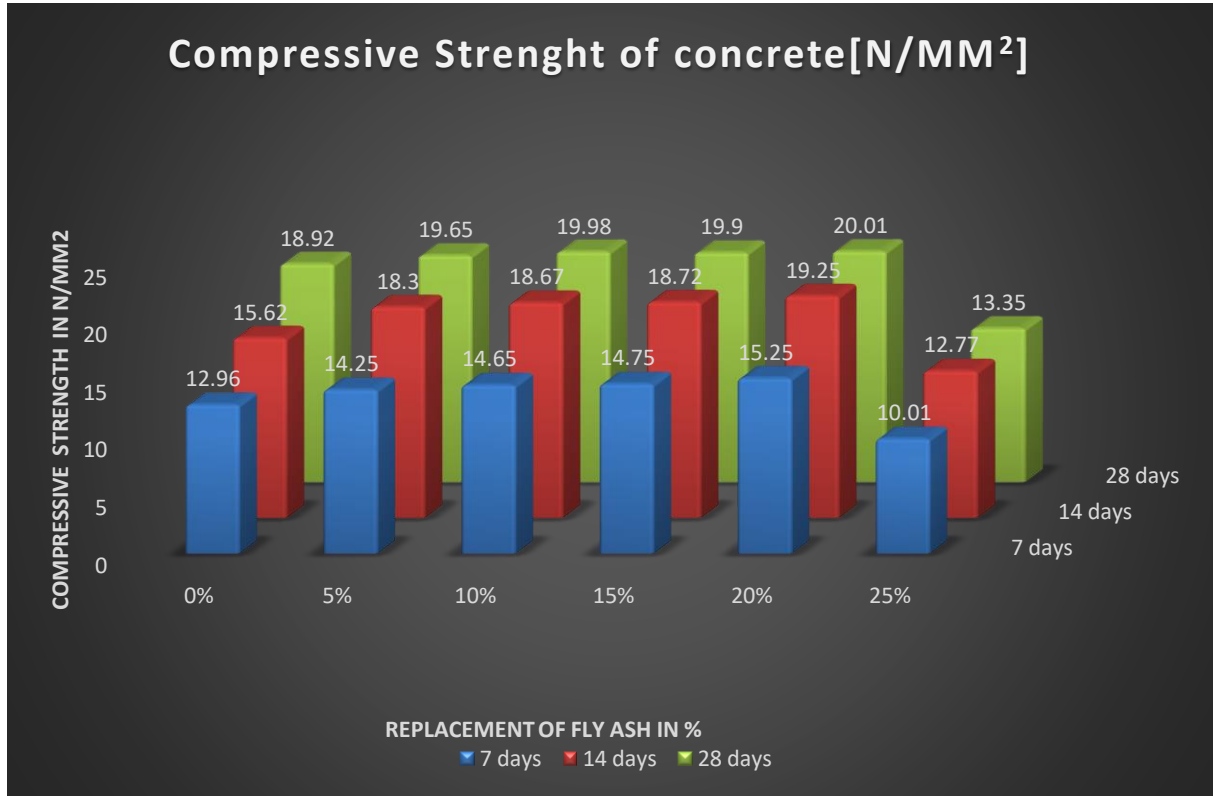

**Graph No 3:-Fly-Ash**

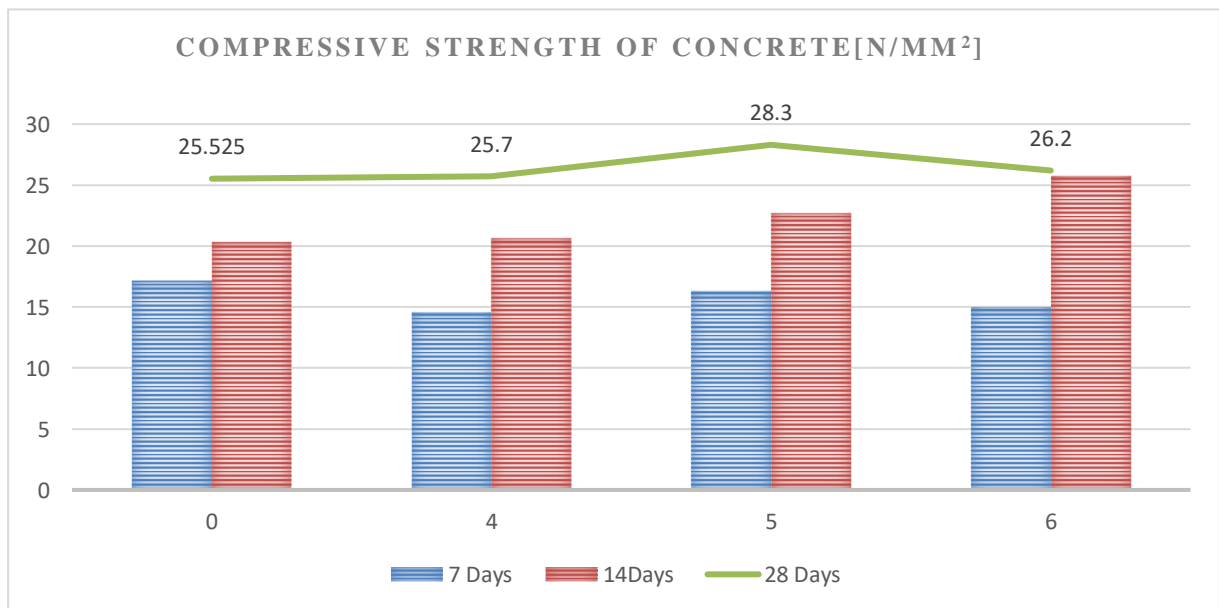

**Graph No 4:- Coconut Fibre**

Comparison of Sustainable Material:

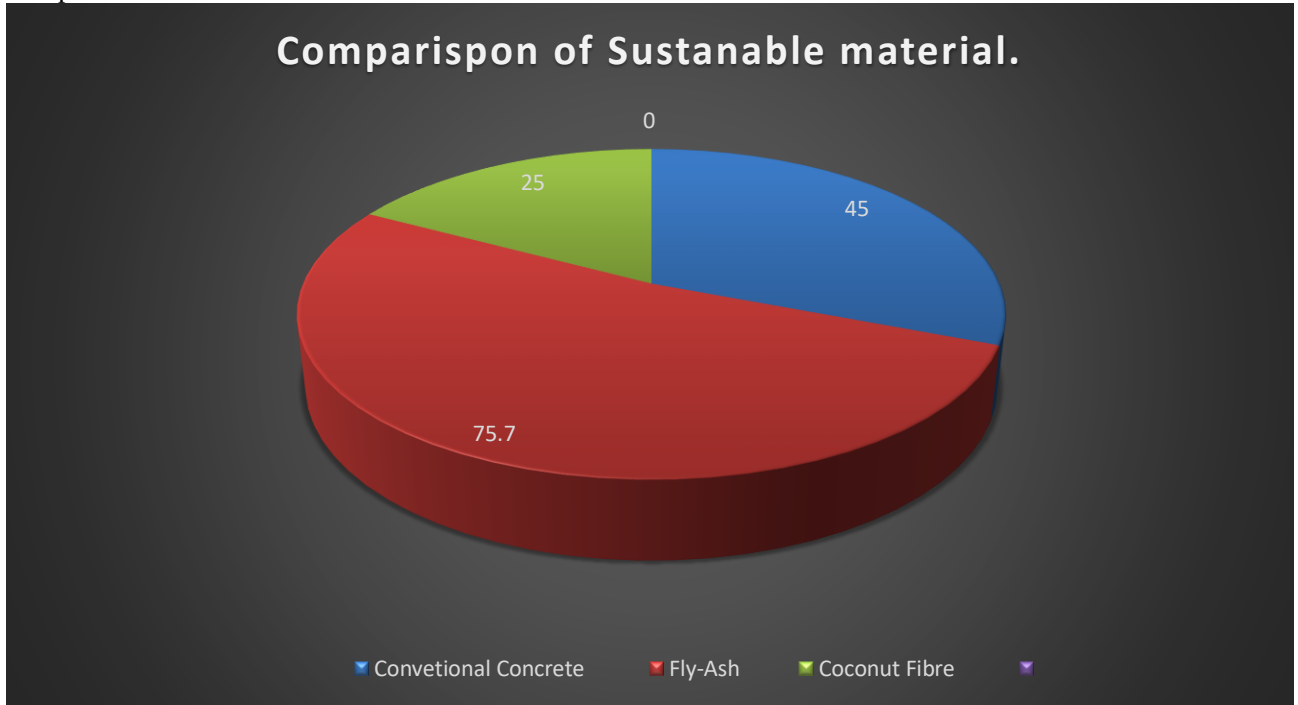

Pie No 1:-Pie chart of Material use.

These are some Result we found out in Testing of sustainable Material.

- The Conventional concrete are wide use in India, But the Fly-Ash result is better thanconventional concrete. We can replace the cement with Flu-Ash at 25% for M20 grade of concrete, But for we found most best result in 20% replacement of Fly-Ash in M20 grade of concrete.
- We can replace Coconut fibre with cement at % of 4, 5, 6, But we get best result on 5%replacement of Coconut fibre.
- So we can replace the sustainable material with % the % are replace depend at grade of concrete.

#### IV. CONCLUSION

1. At the test site, coconut fibre is widely accessible, which makes it a very viable option for concrete reinforcement.
2. Additionally, it serves as a source of income for the coconut producer who profits from the increased demand brought about by the construction sector.
3. Additionally, it is a productive way to dispose of used coir mattresses, which will lessen the need for new waste management facilities and ease the burden on already overburdened landfills and incinerators.
4. Due to their natural nature, coconut fibres are environmentally friendly and have a significant reduction in the global carbon footprint.
5. Compressive strength tests produced the best results with 5% addition of coconut fibre.
6. A water cement ratio of 0.5. However, as more fibres were added, the compressive strength decreased.
7. This must be the result of the fact that when fibres are first added to concrete, the finer sized fine aggregates enter into the surface.
8. Pores in the fibre creating a better bonding between the fibre and mix, but subsequent addition of fibres resulted in formation of bulk fibre in the mix which will lead to decrease in bonding.
9. As a result, the ratio of fibre to cement has an ideal value over which the compressive strength declines. Therefore, 0.5 was chosen as the ideal water cement ratio, and 5% was chosen as the ideal fibre content.

## REFERENCES

- Babak F, Abolfazl H., Alimorad R., Parviz G. Preparation and Mechanical Properties of Graphene Oxide: Cement Nano-composites. *Sci. World J.* 2014;2014:276323. doi: 10.1155/2014/276323.
- Xu S., Zhang B., Chen Z., Yu J., Evans D.G., Zhang F. A General and Scalable Formulation of Pure CaAl-Layered Double Hydroxide via an Organic/Water Solution Route. *Ind. Eng. Chem. Res.* 2011;50:6567–6572. doi: 10.1021/ie102135k.
- Ghaffary A., Moustafa M.A. Synthesis of Repair Materials and Methods for Reinforced Concrete and Prestressed Bridge Girders. *Materials.* 2020;13:4079. doi: 10.3390/ma13184079.
- Cheung J., Jeknavorian A., Roberts L., Silva D. Impact of admixtures on the hydration kinetics of Portland cement. *Cem. Concr. Res.* 2011;41:1289–1309. doi: 10.1016/j.cemconres.2011.03.005. Lothenbach B., Scrivener K., Hooton R. Supplementary cementitious materials. *Cem. Concr. Res.* 2011;41:1244–1256. doi: 10.1016/j.cemconres.2010.12.001. Chalangan N., Farzampour A., Paslar N. Nano Silica and Metakaolin Effects on the Behavior of Concrete Containing Rubber Crumbs. *Civil. Eng.* 2020;1:264–274. doi: 10.3390/civileng1030017.
- Małek M., Jackowski M., Łasica W., Kadela M., Wachowski M. Mechanical and Material Properties of Mortar Reinforced with Glass Fiber: An Experimental Study. *Materials.* 2021;14:698. doi: 10.3390/ma14030698. Al-Najjar Y., Yeşilmen S., Al-Dahawi A.M., Şahmaran M., Yıldırım G., Lachemi M., Amleh L. Physical and Chemical Actions of Nano-Mineral Additives on Properties of High-Volume Fly Ash Engineered Cementitious Composites. *ACI Mater. J.* 2016;113:791–8801. doi: 10.14359/51689114.
- Norhasri M.M., Hamidah M., Fadzil A.M. Applications of using nano material in concrete: A review. *Constr. Build. Mater.* 2017;133:91–97. doi: 10.1016/j.conbuildmat.2016.12.005.
- Stoller M.D., Park S., Zhu Y., An J., Ruoff R.S. Graphene-Based Ultracapacitors. *Nano Lett.* 2008;8:3498–3502. doi: 10.1021/nl802558y.
- Wang W., Chen S.J., De Souza F.B., Wu B., Duan W.H. Exfoliation and dispersion of boron nitride nanosheets to enhance ordinary Portland cement paste. *Nanoscale.* 2017;10:1004–1014. doi: 10.1039/C7NR07561H. Thomas J.J., Jennings H.M., Chen J.J. Influence of Nucleation Seeding on the Hydration Mechanisms of Tricalcium Silicate and Cement. *J. Phys. Chem. C.* 2009;113:4327–4334. doi: 10.1021/jp809811w
- Du H., Du S., Liu X. Durability performances of concrete with nano-silica. *Constr. Build. Mater.* 2014;73:705–712. doi: 10.1016/j.conbuildmat.2014.10.014.
- Oostinga J.B., Heersche H.B., Liu X., Morpurgo A.F., Vandersypen L.M.K. Gate-induced insulating state in bilayer graphene devices. *Nat. Mater.* 2007;7:151–157. doi: 10.1038/nmat2082.
- Palacios T., Hsu A.L., Wang H. Applications of graphene devices in RF communications. *IEEE Commun. Mag.* 2010;48:122–128. doi: 10.1109/MCOM.2010.5473873.
- Shichen Yuan, Boning Han, Tao Fang, Qingsong Shan, Jizhong Song. Flat, Luminescent, and Defect-Less Perovskite Films on PVK for Light-Emitting Diodes with Enhanced Efficiency and Stability. *ACS Applied Electronic Materials* 2020, 2 (11), 3530-3537.
- ParthVashishtha, Swati Bishnoi, C.-H. Angus Li, MetikotiJagadeeswararao, Thomas J. N. Hooper, NainaLohia, Sunil B. Shivarudraiah, Mohammed S. Ansari, Shailesh N. Sharma, Jonathan E. Halpert. Recent Advancements in Near-Infrared Perovskite Light-Emitting Diodes. *ACS Applied Electronic Materials* 2020, 2 (11) , 3470-3490.
- Sen Li, Zhifeng Shi, Fei Zhang, Lintao Wang, Zhuangzhuang Ma, Di Wu, Dongwen Yang, Xu Chen, YongtaoTian, Yuantao Zhang, Chongxin Shan, Xinjian Li. Ultrastable Lead-Free Double Perovskite Warm-White Light-Emitting Devices with a Lifetime above 1000 Hours. *ACS Applied Materials & Interfaces* 2020, 12 (41) , 46330-46339.
- Sijia Li, Huaiyi Ding, HongbingCai, Hui Zhao, Yilong Zhao, Jinlong Yang, Yan Jin, Nan Pan, Xiaoping Wang. Realizing CsPbBr<sub>3</sub> Light-Emitting Diode Arrays Based on PDMS Template Confined Solution Growth of Single-Crystalline Perovskite. *The Journal of Physical Chemistry Letters* 2020, 11 (19) , 8275-8282.
- DandanHao, Junyao Zhang, Shilei Dai, Jianhua Zhang, Jia Huang. Perovskite/Organic Semiconductor-Based Photonic Synaptic Transistor for Artificial Visual System. *ACS Applied Materials & Interfaces* 2020, 12 (35), 39487-39495.
- Wenqing Liang, Zhifeng Shi, Ying Li, Jingli Ma, Shuting Yin, Xu Chen, Di Wu, YongzhiTian, YongtaoTian, Yu Zhang, Xinjian Li, Chongxin Shan. Strategy of All-Inorganic Cs<sub>3</sub>Cu<sub>2</sub>I<sub>5</sub>/Si-Core/Shell Nanowire Heterojunction for Stable and Ultraviolet-Enhanced Broadband Photodetectors with Imaging Capability. *ACS Applied Materials & Interfaces* 2020, 12 (33), 37363-37374.





18. Mingming Chen, Youwen Yuan, Zhaokun Wang, XueminShen, Yuan Liu, Dawei Cao. Optical Property Behaviors of CsPbBr<sub>3</sub> Colloidal Nanoparticles in a Ligand-Assisted Reprecipitation Process. *Crystal Growth & Design* 2020, 20 (8), 4855-4860.
19. Zhuangzhuang Ma, Lintao Wang, XinzhenJi, Xu Chen, Zhifeng Shi. Lead-Free Metal Halide Perovskites and Perovskite Derivatives as an Environmentally Friendly Emitter for Light-Emitting Device Applications. *The Journal of Physical Chemistry Letters* 2020, 11 (14), 5517-5530.
20. Ruei-Hong Shen, Sheng-Hsiung Yang, Pi-Yun Lin. Morphological and Optoelectronic Investigations of CsPbBr<sub>3</sub> Nanocrystals Chelating Diphenylammonium Halide Ligands via Low-Temperature Synthesis. *ACS Applied Electronic Materials* 2020, 2 (6), 1619-1627.
21. Lintao Wang, Zhifeng Shi, Zhuangzhuang Ma, Dongwen Yang, Fei Zhang, XinzhenJi, Meng Wang, Xu Chen, Guangren Na, Shu Chen, Di Wu, Yu Zhang, Xinjian Li, Lijun Zhang, Chongxin Shan. Colloidal Synthesis of Ternary Copper Halide Nanocrystals for High-Efficiency Deep-Blue Light-Emitting Diodes with a Half-Lifetime above 100 h. *Nano Letters* 2020, 20 (5), 3568-3576.
22. Zhuangzhuang Ma, Zhifeng Shi, ChaoChao Qin, Minghuan Cui, Dongwen Yang, Xinjiang Wang, Lintao Wang, XinzhenJi, Xu Chen, Junlu Sun, Di Wu, Yu Zhang, XinJian Li, Lijun Zhang, Chongxin Shan. Stable Yellow Light-Emitting Devices Based on Ternary Copper Halides with Broadband Emissive Self-Trapped Excitons. *ACS Nano* 2020, 14 (4), 4475-4486.
23. Juntao Hu, Qianpeng Zhu, Yuhan Lin, Yang Huang, Kai Xu, PaifengLuo, Chao Zhang, Fei Ding. Efficient CsPbBr<sub>3</sub> Inorganic Perovskite Light-Emitting Diodes via Lewis Acid-Base Reaction with Organic Small Molecule CP. *ACS Applied Electronic Materials* 2020, 2 (2), 597-603.
24. Zhuangzhuang Ma, Zhifeng Shi, Dongwen Yang, Fei Zhang, Sen Li, Lintao Wang, Di Wu, Yuantao Zhang, Guangren Na, Lijun Zhang, Xinjian Li, Yu Zhang, Chongxin Shan. Electrically-Driven Violet Light-Emitting Devices Based on Highly Stable Lead-Free Perovskite Cs<sub>3</sub>Sb<sub>2</sub>Br<sub>9</sub> Quantum Dots. *ACS Energy Letters* 2020, 5 (2), 385-394.
25. Daichi Sato, YoshikiIso, TetsuhikoIsobe. Effective Stabilization of PerovskiteCesium Lead Bromide Nanocrystals through Facile Surface Modification by Perfluorocarbon Acid. *ACS Omega* 2020, 5 (2), 1178-1187.



**INNO SPACE**  
SJIF Scientific Journal Impact Factor  
**Impact Factor: 8.423**



**ISSN** INTERNATIONAL  
STANDARD  
SERIAL  
NUMBER  
INDIA



# INTERNATIONAL JOURNAL OF INNOVATIVE RESEARCH

IN SCIENCE | ENGINEERING | TECHNOLOGY

9940 572 462 6381 907 438 [ijirset@gmail.com](mailto:ijirset@gmail.com)



[www.ijirset.com](http://www.ijirset.com)

Scan to save the contact details