



e-ISSN: 2319-8753 | p-ISSN: 2347-6710

IJRSET

International Journal of Innovative Research in
SCIENCE | ENGINEERING | TECHNOLOGY

INTERNATIONAL JOURNAL OF INNOVATIVE RESEARCH

IN SCIENCE | ENGINEERING | TECHNOLOGY

Volume 12, Issue 5, May 2023

ISSN INTERNATIONAL
STANDARD
SERIAL
NUMBER
INDIA

Impact Factor: 8.423

Comparative Analysis of Hybrid Source Management System for Load Sharing

Prof. Dr. Mrs. V. S, Jape, Akruiti S. Mishra, Pallavi D. Khairnar, Shivam S. Kadam

Associate Professor, Department of Electrical Engineering, P.E.S's. Modern College of Engineering (Affiliated by Savitribai Phule Pune University), Pune, India

Department of Electrical Engineering, P.E.S's. Modern College of Engineering (Affiliated by Savitribai Phule Pune University), Pune, India

ABSTRACT: Microgrid technology efficiently integrates power provided from multiple sources, enabling it to be used for both local and large-scale applications. This technology contributes to increased fuel efficiency and power density. The microgrid is formed by combining renewable energy sources with conventional energy sources, with the renewable energy sources acting as an extension to the conventional source. The proposed system comprises a multi-input system, i.e., solar energy and an energy storage system (battery) coupled together to meet the load sharing requirements of the power system. For micro grid management the simulations are carried out using the MATLAB R2023a programme. The key objective of this project is to optimize the cost and minimize power losses taken from renewable energy sources while developing the microgrid. approaches are considered: the State Flow Approach and Fuzzy Logic Control. The simulation results are assessed for variables such as PV power, grid, energy storage system, and loads, energy storage system (battery) state of charge, and pricing graphs.[6]

KEYWORDS: Microgrid, Solar Array, Energy Storage System, Energy Management System, Load Sharing

I. INTRODUCTION

Energy consumption is very high in all emerging countries, including India, due to rapid population increase. Without energy, any country's social, economic, and industrial growth is nearly impossible. In most urban places, the availability of fossil fuels has decreased. Because fossil fuels are finite electricity resources, continuous power delivery is not achievable. The power network is right now facing numerous issues. The first significant challenge is a lack of power: based on the approaching concept of "electricity to all," adaptations in many areas such as large-scale industrial applications to low power residential appliances are needed.

The second challenge is consumer uncertainty and power system failure. Furthermore, nonrenewable energy sources are contributing to increased air, water, and soil pollution. It also causes a rise in greenhouse gases due to the amount of carbon dioxide emitted, which contributes to global warming. The majority of energy is generated by nonrenewable energy sources such as coal and diesel. However, diesel is not a viable option because it emits three kilograms of carbon dioxide (CO₂) every liter, polluting the environment; thus, renewable energy sources are the best alternative.

Renewable energy generation is the best option for environmental protection. It is a solution to the scarcity of fossil fuels and climate change. There are numerous renewable energy resources available throughout the world. Because of their availability and topological benefits for original power generation in remote places, solar and wind energy systems are regarded as viable power generating sources. However, one common disadvantage of solar and wind energy is their variable nature and reliance on rainfall and climatic fluctuations, and the variations of solar and wind energy may not coincide with the timing of energy consumption. Individualistic usage of both energy resources may result in significant oversizing, making the design more complicated and costly. The fluctuating character of these resources can be partially or completely avoided by integrating solar and wind energy resources in suitable combination, employing the strengths of one source to counteract the weakness of the other. It means that the benefits of both ESS and solar are combined to meet the power requirement, resulting in enhanced efficiency and dependability of the energy supply and a lower demand for energy storage compared to systems that solely use one renewable energy source.[2]

The Source Management System is an essential component of a microgrid since it enables for greater utilization of Renewable Energy Sources. In a microgrid, the Source Management System is defined as a control system that provides the necessary functionality to ensure that both the distribution and generation systems generate power at the lowest possible operational costs. It has a considerable impact on the dependability and efficiency of a microgrid. The paper presents a management system for multi-source systems such as solar, wind, and energy storage. This framework allows users through the process of developing an optimization algorithm that uses anticipated price and loading circumstances to optimize the storage and distribution of energy from a grid-scale battery system

II. PROPOSED SYSTEM

Figure 1 depicts the proposed model. This model incorporates a PV array, an energy storage system, and a power grid that are all connected in parallel, along with fixed and variable load.

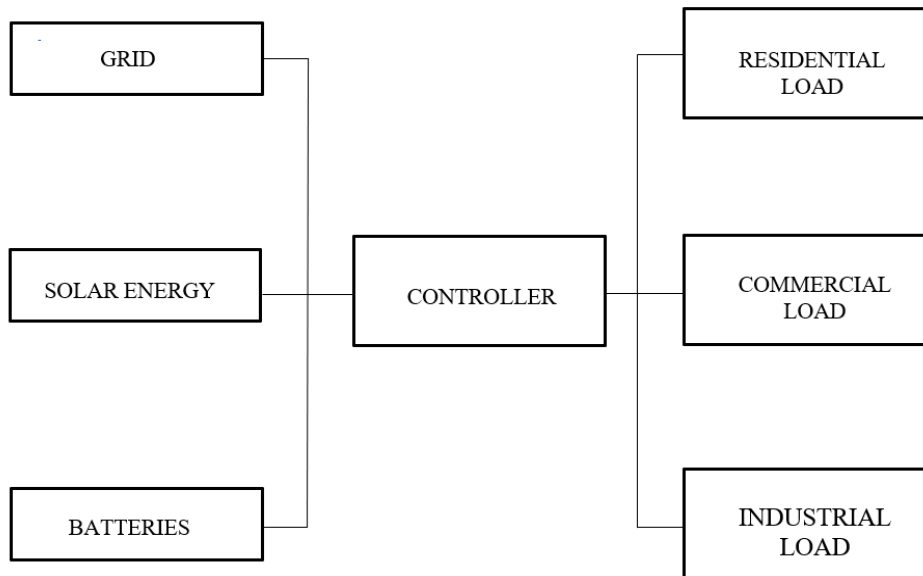

Figure 1: Basic block diagram of the system

Figure 1 depicts the proposed model. This model incorporates a PV array, an energy storage system, and a power grid that are all connected in parallel, along with fixed and variable load.

In this system, priority is given to the source to meet the load sharing criteria. This power can be utilized directly to satisfy load demand, and if the power generated by the PV array exceeds load demand, the extra power can be stored in an energy storage system (ESS), which can subsequently supply power during peak hours when demand is extremely high. Similarly, if the electricity generated by the PV array is less than the load requirement, the load demand can be supplied by the grid.[3]

The proposed model's significant objective is to meet load sharing demands while lowering generation costs to a minimum. And two different approaches to optimization are observed: the Heuristic approach and the Optimization approach.

III. METHODOLOGY

There are numerous optimization strategies, including the Heuristic approach and Linear Programming Optimization methodology employed in this project. A comparative analysis is performed, taking into account elements such as PV array power, grid power, ESS power, and load power. In addition, the ESS's state of charge (SoC) percentage is examined. The cost graphs are observed to figure out the ideal condition that would demand the least amount of capital.[4]

IV. SYSTEM DESCRIPTION

In proposed system, the utility grid of capacity 13.8 kV is considered. Utility grid is connected to the 3-phase 2-winding transformer. After transformer a 3-phase circuit breaker is connected with the variable load to supply power. The total available load of the model is 670 kW which comprises of 320 kW of variable load and 350 kW of fixed load. Solar array block of capacity 535 kW is connected along with the energy storage system of rated power of 400 kW and capacity 3000 kWh.[1]

V. SIMULATON MODEL

The figure.2 presents simulation model of the hybrid microgrid consisting of grid, PV array, energy storage system and loads.

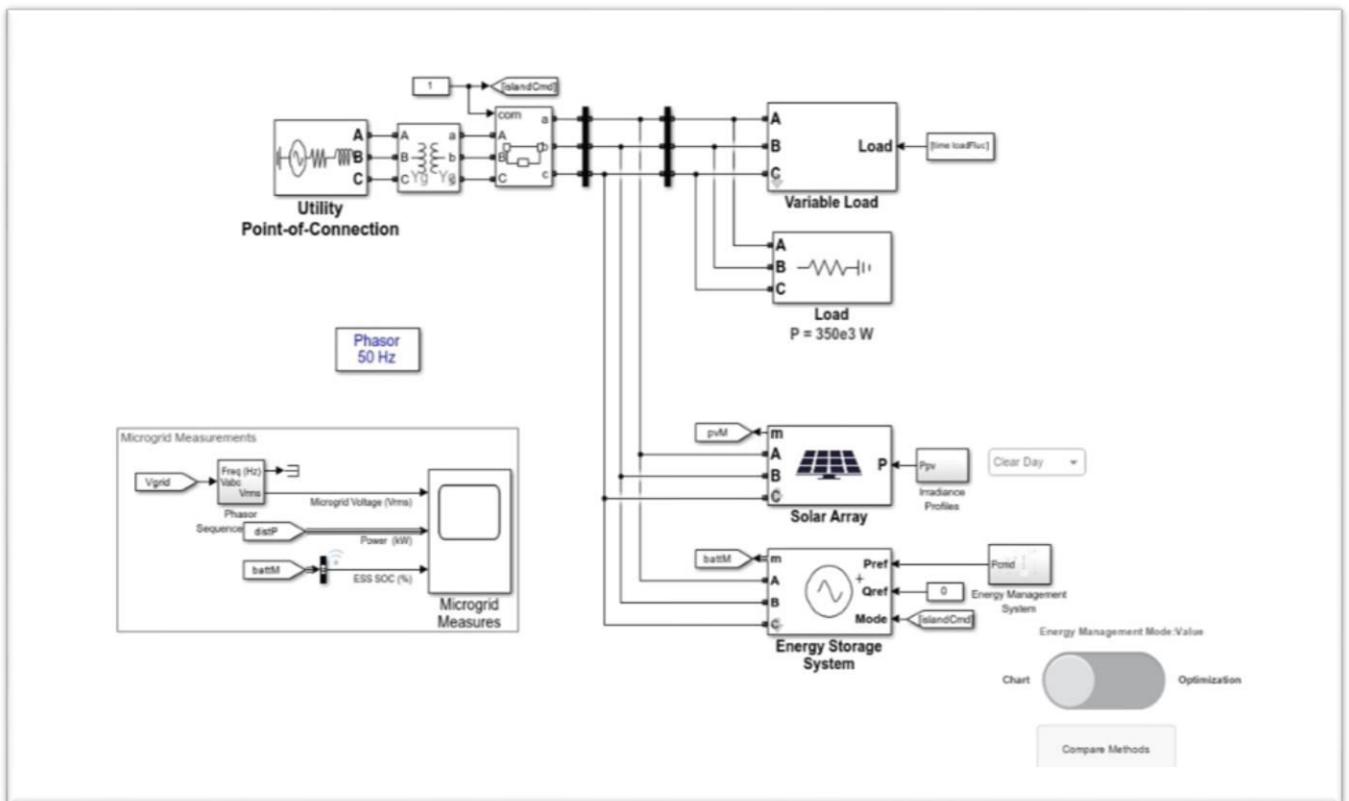

Figure 2: Simulation of the proposed model

VI. SIMULATION RESULTS

The findings are observed using various conditions of clear day and cloudy day. The outcomes of the heuristic and optimization approach are compared.

A. Using Heuristic Method:

- 1) Clear Day:

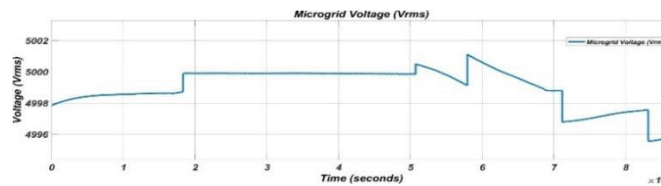

Figure 3 (a)Simulation result for Microgrid Voltage



Figure 3(b): Simulation results for power of different sources

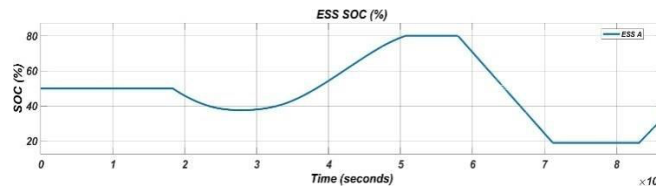

Figure 3(c)Simulation results of ESS SOC%

Figure 3(a) represents the microgrid RMS voltage (Vrms) which shows the fluctuation in voltages because of change in load demands and generations. Figure 3(b) represents the power of photovoltaic (PV), grid, battery and load. Figure 3(c) represents the ESS State of Charge (SOC).

Because the load demand is less than 500kW throughout the timeframe of 0 to 2*10⁴ seconds, the ESS State of Charge (SOC) represents its original capacity, i.e., 50%. As a result, the running cost is kept to a minimum. The load is increased to 500 kW in interval of 2 to 4*10⁴ seconds, and the PV power starts to increase as the battery power decreases. Surplus power is generated as the power of the PV system exceeds the load, and it is stored in the battery. This indicates that the battery is gradually charging. The load remains constant in the interval of 4 to 6*10⁴ seconds, and when the battery voltage reaches the nominal value, it enters the charging mode. As a result, SOC has a charging performance index that is projected to be greater than 80%. The equivalent PV power is reduced, and the battery gradually begins to deliver power, implying that the battery is discharging. The load is increased up to 500kW every 6 to 8*10⁴ seconds, yet the power from the battery remains constant even as the PV output decreases. When the battery is completely discharged and the PV power is not significant, the grid power sets in.[1]

2) Cloudy Day:

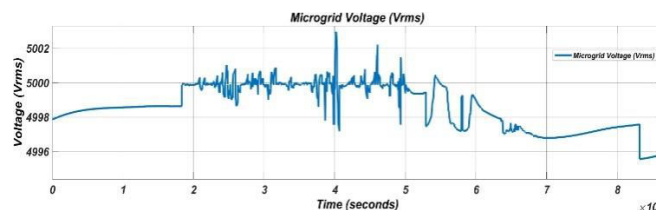

Figure 4 (a)Simulation result for Microgrid Voltage

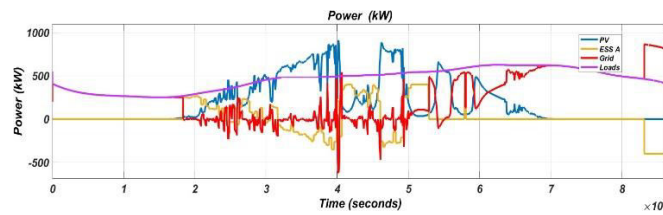

Figure 4(b) Simulation results for power of different sources and load

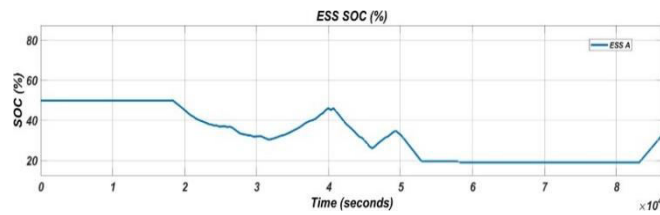

Figure 4(c) Simulation results of ESS SOC%

Figure 4(a) represents the microgrid RMS voltage (V_{rms}) which shows the fluctuation in voltages because of change in load demands and generations. Figure 4(b) represents the power of photovoltaic (PV), grid, battery and load. Figure 4(c) represents the ESS State of Charge (SOC).

Here, at the interval of 0 to 2×10^4 seconds, as the load demand is less, so, the ESS SOC represents its initial capacity i.e., 50% and corresponding to that the operating cost is minimum. In the interval of 2 to 4×10^4 seconds, the load is slightly increasing up to 500 kW same as that of clear day. The solar array power starts increasing while battery simultaneously fluctuates between that time period because of the change in weather. Because of the increasing in the solar array above the load, surplus power is generated which gets stored in the battery which means the battery starts to charge. In the interval of 4 to 6×10^4 seconds, the load remains stable but the battery is not fully charged due to changes in the weather. Accordingly, the solar power decreases and the battery slowly starts to supply the power. In the interval of 6 to 8×10^4 seconds, the load is increased up to 500 kW, at an instant the battery gets discharged and the solar power is negligible, then grid power sets in. [1]

B. Using Optimization Method

1) Clear Day:

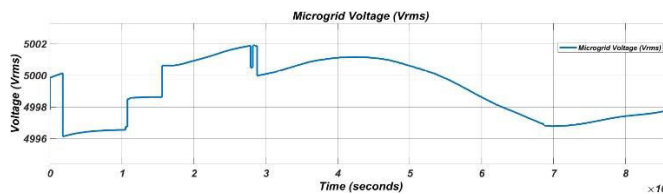

Figure 5(a) Simulation result for Microgrid Voltage

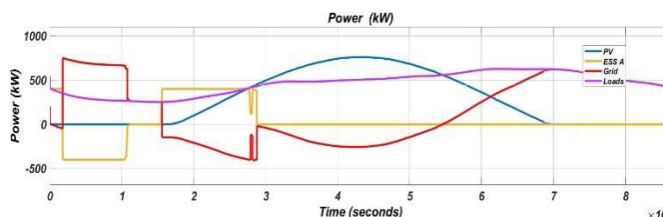

Figure 5(b) Simulation results for power of different sources and load

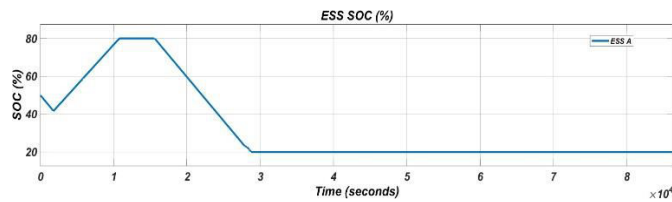

Figure 5(c) Simulation results of ESS SOC% for clear day using Optimization Method

Figure 5(a) represents the microgrid RMS voltage (Vrms) which shows the fluctuation in voltages because of change in load demands and generations. Figure 5(b) represents the power of photovoltaic (PV), grid, battery and load. Figure 5(c) represents the ESS State of Charge (SOC).

Here, at the interval of 0 to 2×10^4 seconds, the load demand is less, so, during that time the solar array and battery both do not supply power. The grid supplies power and during that time period battery gets fully charged. Afterwards, grid supply is decreasing because of solar array and battery supply the power and battery gets discharged. In the interval of 2 to 4×10^4 seconds, the load is slightly increasing up to 500 kW. The PV power is on the verge of increasing. In the interval of 4 to 6×10^4 seconds, the load remains constant and when the battery voltage reaches the nominal battery voltage, it reaches the charging mode. In the interval of 6 to 8×10^4 seconds, the load is increased up to 500 kW. At an instant the battery slowly discharges and the solar power is not significant, then grid power sets in. [1]

2) Cloudy Day:

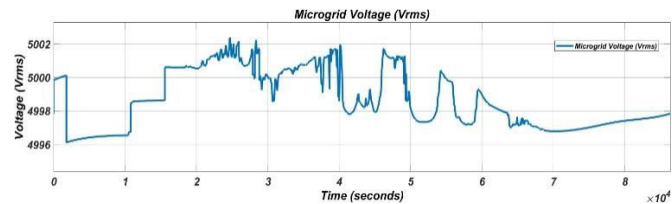

Figure 6(a) Simulation result for Microgrid Voltage

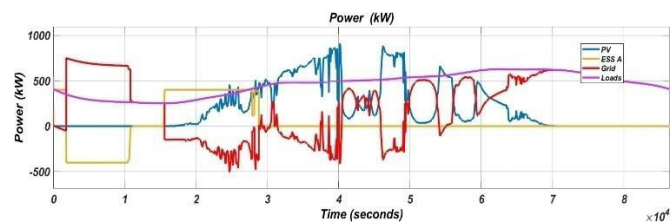

Figure 6(b) Simulation results for power of different sources and load

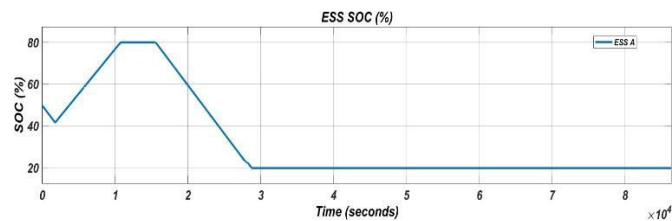

Figure 6(c) Simulation results of ESS SOC%

Figure 6(a) represents the microgrid RMS voltage (Vrms) which shows the fluctuation in voltages because of change in load demands and generations. Figure 6(b) represents the power of photovoltaic (PV), grid, battery and load. Figure (c) represents the ESS State of Charge (SOC).

Here, at the interval of 0 to 2×10^4 seconds, the load demand is less, so, during that time the solar array and battery both do not supply power. The grid supplies power and in that time period battery is charging to its full capacity. Thus, operating cost is increasing, the grid supply decreases because of the power supply from solar array and battery. Accordingly, the operating cost



is minimum. In the interval of 2 to 4 *10⁴seconds, the load is slightly increasing upto 500kW. The power of solar array increases while battery supplies power and reaches its nominal capacity. In the interval of 4 to 6 *10⁴seconds, the load remains constant and when the battery voltage reaches the nominal battery voltage, it reaches the charging mode. As a result, SOC has a charging performance index estimated over 80%. The battery gets slowly discharged and the solar power is negligible, then grid power sets in.[1]

The table shown below is the comparative analysis of power generated for the considered hybrid system for both the approaches that are Heuristic and Optimization for both clear and cloudy day.

Heuristic Approach on a clear day.	Optimization Approach on a clear day.	Heuristic Approach on a cloudy day.	Optimization Approach on a cloudy day.
<ul style="list-style-type: none"> • PV Array generates maximum power which is provided to loads and excess energy generated is supplied to Energy Storage System which is used at night. • In the Power graph, power required is more than Optimization approach on a clear day. 	<ul style="list-style-type: none"> • PV Array generates maximum power which is provided to loads and excess energy generated is supplied to Energy Storage System which is used at night. • In the Power graph, grid power required is less than Heuristic approach on a clear day. 	<ul style="list-style-type: none"> • PV Array generates minimum power due to less solar irradiance. Thus, maximum power is taken from grid to supply for loads and charge Energy Storage System. • In the Power graph there are many fluctuations in PV and Grid profile. • Grid power is taken less than solar 	<ul style="list-style-type: none"> • PV Array generates minimum power due to less solar irradiance. Thus, maximum power is taken from grid to supply for loads and charge Energy Storage System. • In the Power graph there are many fluctuations in PV and Grid profile. • Grid power is taken more than solar

Table 1: Comparative study for Heuristic approach and Optimization approach for clear and cloudy day

VII. CONCLUSION

This paper presents the Microgrid (MG) integrated Energy Management System (EMS) paradigm. In this case, a PV array and an ESS, or Energy Storage System, are coupled with a traditional grid to meet load demand. The study focuses mainly on two methods: the use of heuristics using State Machine Logic (State flow method) and the optimization approach using linear programming. These approaches have been selected because of their feasibility, reliability, and resource availability in the microgrid environment. The proposed model has been executed in the MATLAB environment. In this paper, the power graphs have been compared using the Heuristic approach and the Optimization approach. In accordance with the simulation results, the amount of power required from the grid using the Optimization approach is less than that required using the Heuristic approach on a clear day. On cloudy days, the Heuristic technique uses grid power rather than solar, although there are frequent variations in the PV and Grid profiles in the power graph. In the case of the optimization technique, maximum power is drawn from the grid to provide loads and charge the Energy Storage System, and there are numerous variations in the power graph.[7]

REFERENCES

[1] Jigar S. Sarada, Kwang Lee, Hirva Patel, Nishita Patel, Dhairya Patel, “Energy Management System of Microgrid using Optimization Approach”, IFAC Papers Online 55-9 (2022) 280–284, 2022.
 [2] Obaidullah Lodin, Nitin Khajuria, Satyanand Vishwakarma, Gazia Manzoor, “Modeling and Simulation of Wind Solar Hybrid System using Matlab/Simulink”, International Journal of Innovative Technology and Exploring Engineering (IJITEE) ISSN: 2278-3075, Volume-8, Issue-9S, July 2019
 [3] Nandkumar K. Patil, Dr. P.K.Katti, “Load Sharing and Source Management in Hybrid Power System”, IEEE, International Conference on circuits Power and Computing Technologies [ICCPCT], 2017
 [4] A. Naamane, N.K. Msirdi, “Improving Multiple Power Sources Management Using State Flow Approach”, DOI: 10.1007/978-3-642-36645-1_69, Conference Paper, September 2017



- [5] Shashi Shanker, BSSPM Sharma, “Optimization of Solar and Wind Hybrid System”, International Journal of Science and Research (IJSR), ISSN(Online): 2319-7064, Impact Factor (2017): 3.358
- [6] Masoud Safari, Mohammad Sarvi, “Optimal load sharing strategy for a wind/diesel/ battery hybrid power system based on imperialist competitive neural network algorithm”, IET Renewable Power Generation, ISSN 1752-1416, 9 April 2016.
- [7] Mhusa N. J, Nyakoe G. N, Mgaya E. V, “Power Management in Photovoltaic-Wind Hybrid System Based on Artificial Intelligence”, Journal of Multidisciplinary Engineering Science and Technology (JMEST) .Vol. 2 Issue 1, Pp 140, January – 2015.



INNO SPACE
SJIF Scientific Journal Impact Factor
Impact Factor: 8.423



ISSN INTERNATIONAL
STANDARD
SERIAL
NUMBER
INDIA



INTERNATIONAL JOURNAL OF INNOVATIVE RESEARCH

IN SCIENCE | ENGINEERING | TECHNOLOGY

9940 572 462 **6381 907 438** **ijirset@gmail.com**



www.ijirset.com

Scan to save the contact details