



e-ISSN: 2319-8753 | p-ISSN: 2347-6710

IJRSET

International Journal of Innovative Research in
SCIENCE | ENGINEERING | TECHNOLOGY



INTERNATIONAL JOURNAL OF INNOVATIVE RESEARCH

IN SCIENCE | ENGINEERING | TECHNOLOGY

Volume 13, Issue 4, April 2024

ISSN INTERNATIONAL
STANDARD
SERIAL
NUMBER
INDIA

Impact Factor: 8.423

9940 572 462

6381 907 438

ijirset@gmail.com

www.ijirset.com

Regeneration of Electricity through Heat Dissipated By Li-Ion Battery in EV Vehicles

Pranay Kolekar, Shubham Patil, Omkar Waghmare, Bhuvaneshwari Bhosale, Prof. M. M. Kharade

Students, Department of Electrical Engineering, KJ'S Trinity College of Engineering & Research, Pune, India

Department of Electrical Engineering, KJ'S Trinity College of Engineering & Research, Pune, India

ABSTRACT: A Thermoelectric Generator (TEG) and Thermoelectric Cooler (TEC) battery cooling system is a cutting-edge technology designed to optimize the performance and lifespan of batteries in various applications, such as electric vehicles and renewable energy storage systems. This system leverages the thermoelectric effect, where temperature differentials are harnessed to generate or dissipate heat. In the context of battery cooling, TEGs efficiently remove excess heat generated during charging and discharging processes, thereby preventing overheating and thermal degradation. Conversely, TECs enable precise temperature control by either heating or cooling the battery cells as needed. This innovative approach not only enhances battery efficiency but also extends their operational life, making it a crucial development in the field of energy storage and electric mobility.

I. INFORMATION

Renewable energy-based applications, such as consumer electronics, vehicles, and even buildings, are emerging as the world turns 'green'. For instance, the discharge rate will determine the acceleration process of electric and hybrid electric vehicles. The lifespan of batteries also greatly depends on the operating temperature. Under normal operating conditions, of say -30°C to 60°C , the battery health varies significantly from the optimal battery temperature range. However, studies suggest that working at above 50°C can be harmful to the lifespan of batteries "Further studies indicated that a temperature range from 25°C to 40°C (a maximum 5°C difference from this temperature range) provides the best working environment for batteries such as lead-acid, NiMH, and Li-ion". Efficient temperature management systems contribute significantly to battery health and extend the overall lifespan. Moreover, as the capacity and charge/discharge rate increase, battery security issues need more attention. Subsequently, various BTMS' has been developed to meet the demand for higher power, faster charge rates, and improved drivin performance. Modern BTMS' are divided into two groups: active systems and passive systems. Passive BTMS generally employ phase change materials, heat pipes, and hydrogels. Zero extra power consumption is the most prominent feature of these systems. However, the cooling process is difficult to manage. The main issue is that the cooling effect can be very limited under certain circumstances. Thermoelectric power generation devices for vehicles have been developed for years. In contrast, thermoelectric coolers (TEC) which employed by battery thermal management are a comparatively new candidate for electric vehicles. These benefit from strong cooling capacities and reliable working potential, and have attracted increasingly more attention for integration into BTMS. Thermoelectric coolers (TEC) are based on the conversion of voltage to the temperature difference. This Peltier- See-beck effect together with Thompson effect belongs to the thermoelectric effect. The thermoelectric effect refers to all of the transformation processes from heat to electricity, and vice versa. The main advantages of thermoelectric coolers are relatively quiet, stable, and reliable. Furthermore, the temperature can be easily controlled by varying the voltage supply.

1.1 OBJECTIVES:

- 1 Develop a TEG&TEC-based air conditioning prototype for EVs.
- 2 Optimize the cooling efficiency of the system while minimizing power consumption.
- 3 Implement a reliable temperature control mechanism for cabin comfort.
- 4 Ensure safety features to prevent overheating and electrical issues.
- 5 Evaluate the system's performance through testing and data analysis.
- 6 Assess the feasibility of integrating the Peltier system into commercial EVs for practical use.

1.2 EXPECTED OUTCOMES:

The TEG (Thermoelectric Generator) and TEC (Thermoelectric Cooler) battery cooling system is expected to deliver a

significant enhancement in battery performance and longevity. By harnessing the principles of thermoelectricity, this innovative technology will effectively regulate the temperature of battery packs in electric vehicles and other applications. As a result, it is anticipated that the TEG and TEC cooling system will mitigate the adverse effects of extreme temperatures on battery cells, which can lead to reduced energy efficiency and accelerated degradation. The expected outcome of this system includes improved energy storage, extended battery life, and enhanced overall reliability, ultimately contributing to the advancement of sustainable and efficient energy solutions in various sectors. Additionally, this technology is poised to reduce the need for frequent maintenance and replacement of battery packs, thereby offering cost savings and a more environmentally friendly approach to energy storage and utilization.

II. LITRATURE REVIEW

To successfully complete the project, literature review is the first and most important step. This gives a detailed and thorough review of the literature in the area of power quality problems on power system operation and dynamic voltage restorer. The literature includes technical papers from IEEE journals and few other sources.

Xiaoli Ma et al . This project explains about many new types of thermal energy sensors based on Peltier effect or Seebeck effect of the thermoelectric modules have been developed. The following are some examples of the thermoelectric thermal energy sensors.

Xiaoli Ma et al . This project explains about many new types of thermal energy sensors based on Peltier effect or Seebeck effect of the thermoelectric modules have been developed. The following are some examples of the thermoelectric thermal energy sensors.

Sara Abada et al. This study emphasises about LIBs: Therefore, when LIBs are operated improperly, either outside of the specifications of its manufacturer or due to cell defects, electrical and chemical energies inside the cells can be unintentionally released and lead to gassing, fires, or even explosions. During these incidents, the most energetic catastrophic failure of a LIB system is a cascading thermal runaway event. This is characterized by a deficit of energy evacuation versus energy accumulation in the cells, leading to uncontrollable overheating of the battery system.

Bohayra Mortazavi et al. In this investigation, multiscale modelling techniques were developed to explore the efficiency in the thermal management of rechargeable batteries through employing the paraffin composite structures. A combined atomistic continuum multiscale modelling was conducted to evaluate the thermal conductivity of paraffin reinforced with graphene or hexagonal boron-nitride nanosheet additives. In addition, heat generation during a battery service was simulated using the Newman's electrochemical model.

Guiwen Jiang et al. In order to evaluate the effect of the baffles on improving air fluid heat transfer, in this paper a three three-dimensional model of the tube-shell attery module with forced air cooling was performed using ANYSYS FLUENT. The thermal characteristics of the tube-shell battery pack were investigated both experimentally and numerically.

Z. J. An et al. Details of various thermal management technologies are mentioned in this paper, thermal management technologies namely air based, phase change material based, heat pipe based and liquid based, are discussed and compared from the perspective of improving the external heat dissipation. The selection of different battery thermal management (BTM) technologies should be based on the cooling demand and applications, and liquid cooling is suggested being the most suitable method for large scale battery pack charged/discharged at higher C-rate and in high-temperature environment.

TEG & TEC:

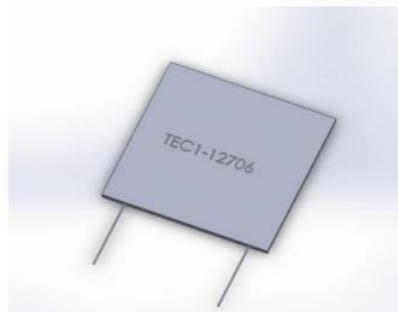

The Thermoelectric generator works on the principle of the See-beck effect. When two junctions formed by joining two dissimilar materials maintained at different temperatures, an voltage of the order $\mu\text{V/K}$ is generated. The materials used here are called thermoelectric materials. The selection of these materials is based on their properties like, thermal conductivity, electrical conductivity, See-beck coefficient etc. The amount of power generated by the TEG depends on the temperature difference between the opposite faces of the TEG. When one surface is maintained at a higher temperature heat gets conducted to the other surface which reduces the temperature difference. Hence a heat exchanger needs to be designed to maintain low temperature on the other face. The objectives of the present study are to fabricate and study the performance of TEG for different temperatures.

An emissivity apparatus was used for the experiment which had an electric heater with a knob to adjust the heat supplied, thermocouples to measure the temperature at the bottom surface of the TEG module. An aluminium heat exchanger was fabricated to improve cooling on the other side of the module to create a higher temperature gradient which would result in higher power generation from the TEG module. A multi meter was used to measure the current and voltage output from the leads of the module.

The heater in the emissivity apparatus was used to heat the bottom side of the emissivity module. Readings of voltage and current output from the TEG module were taken using a multi meter from 35 degree Celsius onwards for every 10°C rise in temperature. This was continued until a temperature of 145 degree Celsius was reached.

What are Thermoelectric Power Generators?

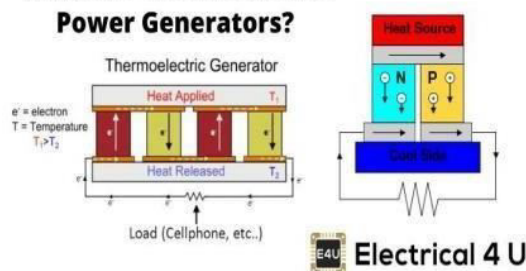

Renewable energy-based applications, such as consumer electronics, vehicles, and even buildings, are emerging as the world turns ‘green’. Electric vehicle and hybrid electric vehicle (EV/HEV) technology, as a green substitute for conventional combustion vehicles, has attracted a significant amount of attention globally and are quickly replacing internal combustion engine-powered vehicles.

Batteries play an increasingly critical role in renewable energy usage and storage. As an example, the performance of EVs and HEVs are highly dependent on battery capacity. Battery thermal management systems (BTMS’) are developed to monitor and optimize the thermal status of batteries. The battery temperature is a critical 4 factor for battery operating performance. Specifically, the charge/discharge capacity can be strongly influenced by temperature.

The temperature difference, the greater the electrical energy produced. However, if the temperature difference is too large, it will cause damage to the bismuth semiconductor material used. This scheme can be seen in below fig

Lithium-ion and Electron formed during the charging stage is a highly unstable stage so when the power source is replaced by a load the battery starts to discharge. The lithium-ion moves towards the metal oxide via the electrolyte to form a more stable lithium metal oxide state.

The electrons start moving towards the anode through the load and thus we get electric current through the load. When all the electrons and lithium-ion go back to a more stable state it discharges the battery. Graphite used in the cell acts as a storage medium for the lithium-ion and does not actively take part in the chemical reaction.

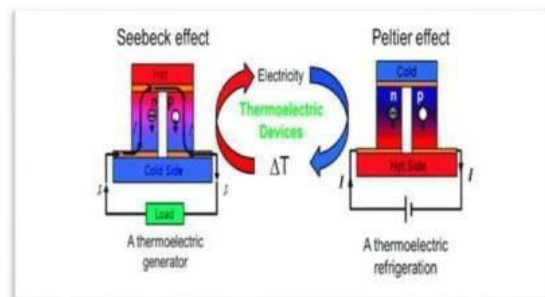

This process along with electricity also produces heat. Lithium-ion batteries generate heat due to complex internal working mechanism like: 1) exothermic chemical reaction. 2) ohmic resistance. 3) cell polarization due to difference in the battery potential during discharging and charging of open circuit. 4) Lithium-ion batteries undergo thermal runaway under certain conditions.

III. METHODOLOGY

Many different materials are available for making TEG modules. Since Bismuth telluride has better power rating and is abundantly available hence, we used Bi₂Te₃ TEG module in this study. A heat exchanger has been designed to maintain temperature difference between the two faces of the TEG. We used Aluminium heat exchanger because of its high thermal conductivity. Parameters considered for the design of heat exchanger were the amount of heat to be pumped and the flow rate of water needed. We maintained a constant water flow rate in the heat exchanger. The specifications of the TEG used are as follows.

The maximum operating temperature - 230°C Open circuit voltage is 12.1 volts Dimensions 40mm*40mm*3.4mm

The thermo electric material used is Bi₂Te₃ and its properties are Thermal conductivity = 2 W/m-K Density = 7790 Kg/m³ Specific heat = 250 J/Kg-K

TEG is covered by ceramic plates of 0.8mm thick on both sides and the thermal conductivity and density of the material is 30 W/m-K and 3300 Kg/m³ respectively.

IV. DESIGNING:

Design of Components:

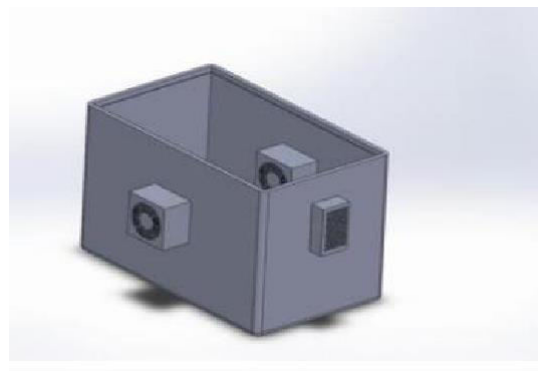

Fig. 5.1.1 Assembly of Model Dimensions

Dimensions L*B*H = 160*70*100

TEG and TEC PLATE:

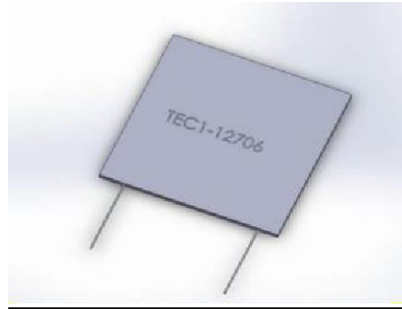

Fig. 5.2 TEG and TEC PLATE Design Dimensions

Dimensions L * B * H = 40*40*40 mm Thickness = 3 mm

Thermoelectric generators could be used in power plants and factories to convert waste heat into additional electrical power and in automobiles as automatic thermoelectric generators to increase fuel efficiency. Radioisotope thermoelectric generators use radioisotopes to generate the required temperature difference to power space probes. Thermoelectric generators can also be used alongside solar panels.

Switched-mode power supply:



Fig 5.3 Switched-mode power supply

Dimensions L * B * H = 130*100*40 mm

A switched-mode power supply (SMPS), also called switching-mode power supply, switch mode power supply, switched power supply, or simply switcher, is an electronic power supply that incorporates a switching regulator to convert electrical power efficiently. A switched-mode power supply (switching mode power supply, SMPS, or switcher) is an electronic power supply that incorporates a switching regulator to convert electrical power efficiently. The Meanwell range of switch mode power supplies are designed to be high quality AC to DC converters. Their open case design allows them to be cooled either by free air convection or by fan forced air. All models come with short circuit, overload and over voltage protection, to guarantee performance. Allowing it to power a large number of mid voltage applications.

Cooling Fan:



Fig. 5.4 Cooling Fan Design

Dimensions 80x80mmx25mm

They are typically found in ATX Computer cases, servers, and other enclosed equipment but they can also be used in a variety of other projects requiring moderate airflow.

TEG & TEC Plate:

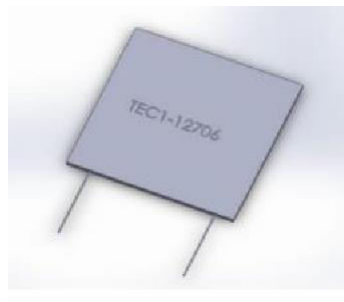

Fig.5.5 TEG & TEC Plate

Peltier elements (also called thermoelectric coolers (TEC)) and thermoelectric generators (TEG) for the usage as thermoelectric power generators. in wireless sensors or exhaust pipes. The efficiency of thermoelectric materials for the low temperature sector (between 0 °C and 200 °C) is not very high, but the costs for TEGs are. Therefore, in this contribution, TECs and TEGs are tested and compared under the same conditions.

Temperature Sensors:



Fig. 5.6 Temperature Sensors We are the leading suppliers for LM35. Specifications:

*Calibrated Directly in Celsius (Centigrade)

*Non-Linearity Only $\pm 1/4^\circ\text{C}$ Typical

*Low-Impedance Output, 0.1 Ω for 1-mA Load

5.7.Electric Heater:



Fig.5.7 Electric Heater

Electric heating is produced by using a known resistance in an electric circuit. This placed resistance has very few free electrons in it so it does not conduct electric current easily through it. When there is resistance in the flow of electrons, then this resistance will produce heat. The heat produced will be the heat energy required for electric devices to work. Electric heating is the most efficient but an expensive process because this resistant heating will take a lot of electrical energy. The price of electricity is too high compared to other energy resources such as water, gas and fossil fuels. Compared to the other factors such as purchasing price and installation of these electric heaters is quite less that attracts the buyers. When it is used for domestic purposes, it is generally insulated with some plastic materials to save the residents from electric shocks and to minimize the energy dissipation.



Fig.5.8 Battery

A battery is a source of electric power consisting of one or more electrochemical cells with external connections for powering electrical devices. When a battery is supplying power, its positive terminal is the cathode and its negative terminal is the anode. The terminal marked negative is the source of electrons that will flow through an external electric circuit to the positive terminal. When a battery is connected to an external electric load, a redox reaction converts highenergy reactants to lower-energy products, and the free-energy difference is delivered to the external circuit as electrical energy. Historically the term "battery" specifically referred to a device composed of multiple cells; however, the usage has evolved to include devices composed of a single cell.

Dimensions L * B * H = 151*65*93 Thickness = 6.3mm

An automotive battery or car battery is a rechargeable battery that is used to start a motor vehicle. Its main purpose is to provide an electric current to the electricpowered starting motor, which in turn starts the chemically-powered internal combustion engine that propels the vehicle. Once the engine is running, power for the car's electrical systems is still supplied by the battery, with the alternator charging the battery as demands increase or decrease.



V. EXPERIMENTAL ANALYSIS

- 1. TEG Performance Analysis: Temperature Gradient Study:** Measure and analyse the temperature gradient across the Peltier modules during the TEG operation. Evaluate the electrical power generated at different temperature differentials to understand the system's efficiency. **Heat Source Variability:** Experiment with different heat sources to simulate real-world scenarios. Assess the system's adaptability to varying heat inputs and its ability to generate consistent electrical power.
- 2. TEC Cooling Efficiency: Battery Temperature Control:** Conduct experiments to actively cool batteries using the TEC components. Monitor the battery temperature under different load conditions and ambient temperatures to ensure effective thermal management. **Cooling Power vs. Electrical Consumption:** Analyse the trade-off between the electrical power consumed by the TEC for cooling and the cooling power delivered to the batteries. Optimize the TEC operation to achieve efficient cooling without compromising energy harvested by the TEG.
- 3. System Integration and Synergy: Combined Operation:** Investigate the performance of the entire integrated system, considering both TEG and TEC components simultaneously. Evaluate how the system manages to harvest waste heat for electricity while maintaining optimal battery temperatures. **Dynamic Conditions:** Subject the system to dynamic conditions that mimic real-world scenarios, such as sudden changes in load, ambient temperature fluctuations, and varying heat sources. Assess the system's responsiveness and stability.
- 4. Heat Exchange Mechanism: Heat Exchange Surface Design:** Experiment with different heat exchange surfaces to optimize the thermal coupling between the Peltier modules and the heat source/heat sink. Evaluate the impact on both TEG and TEC performance. **Material Durability:** Assess the durability of materials used in the Peltier modules under prolonged experimental conditions.
- 5. Data Collection and Analysis: Quantitative Measurements:** Collect quantitative data on electrical power output, temperature differentials, and battery temperatures. Utilize this data to calculate system efficiency and identify potential areas for improvement. **Comparison and Validation:** Compare experimental results with theoretical predictions and models. Validate the accuracy of the system's performance against initial design expectations.

VI. RESULT

Sr. No.	V (output voltage)	ΔT (Temperature difference)
1	0.30	20
2	0.60	52
3	0.86	77.3
4	1.02	80.8
5	1.40	83.1
6	1.90	86.4
7	2.10	89.4
8	2.56	90.2
9	2.86	93
10	3.18	94

Sr.No.	P (Output power),W	Qin (Input heat added), W	Efficiency, $\eta=P/Q_{in}$
1	0.04	400	0.011
2	0.11	400	0.028
3	0.21	400	0.053
4	0.30	400	0.075
5	0.42	400	0.105
6	0.66	400	0.165
7	0.84	400	0.210
8	1.14	400	0.285
9	1.43	400	0.358
10	2.07	400	0.510

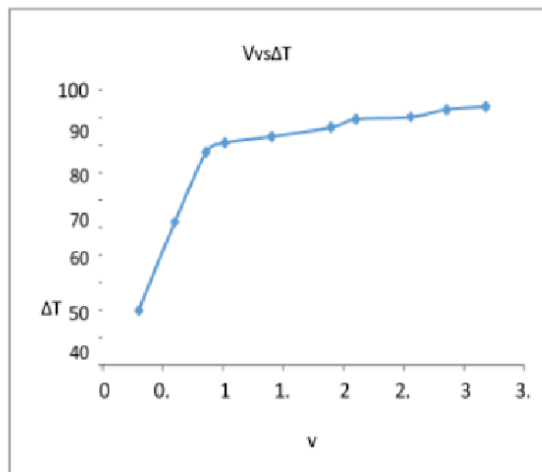

Fig.7.1 Temperature difference vs. voltage

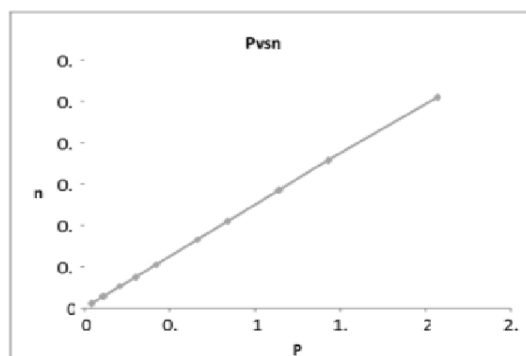

Fig.7.2 Power output vs. efficiency graph

Sr.No.	V (output voltage)	I (Current) A
1	0.30	0.11
2	0.60	0.18
3	0.86	0.25
4	1.02	0.29
5	1.40	0.30
6	1.90	0.35
7	2.10	0.40
8	2.56	0.45
9	2.86	0.50
10	3.18	0.65

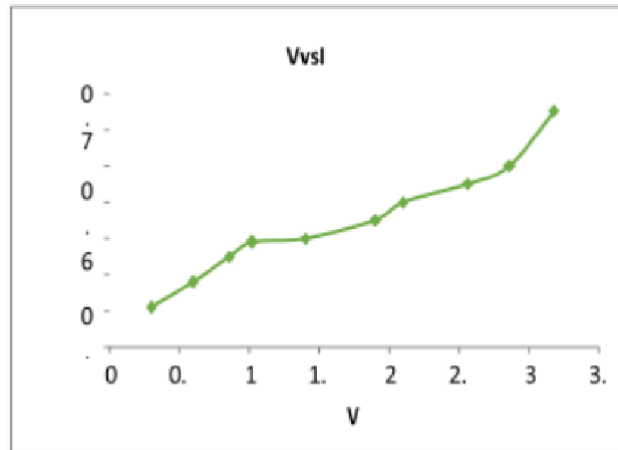

Fig.7.3 Voltage Vs Current Graph

VII. CONCLUSION

The TEG and TEC battery cooling system using Peltier plate modules has demonstrated significant potential as an innovative and sustainable solution. By effectively combining energy harvesting and thermal management, the system addresses critical challenges in power generation and battery cooling. The findings from this project pave the way for further advancements in thermoelectric technologies, contributing to the development of efficient and environmentally friendly energy systems. As we move forward, continued research and refinement will be key to unlocking the full potential of this integrated system for a wide range of practical applications.

REFERENCES

1. Y. Lyu , A.R.M. Siddique , S.H. Majid , M. Biglarbegian , S.A. Gadsden , S. Mahmud,* “Electric vehicle battery thermal management system with thermoelectric cooling” June 2019
2. Trevor Hocksun Kwan , Xiaofeng Wu , Qinghe Yao “Complete implementation of the combined TEG-TEC temperature control and energy harvesting system”
3. Chaitanya Pandya¹, Dhrunil Timbadia² “A Detailed Review on Cooling System in Electric Vehicles” e-ISSN: 2395- 0056 Volume: 08 Issue: 06 | www.irjet.net p-
4. ISSN: 2395-0072 . June 2021
5. M. BENZAADA, F. METEHRI, S. DELLA KRACHAI “Comparative Analysis of Thermoelectric Generators Parameters”
6. DOI: 10.37394/232012.2021.16.2 2021
7. Kevin Wang Jonathan Ripheden “Thermal management system for lithium-ion batteries” TRITA-
8. ITM-EX 2022:185. 2021
9. Hussam Jouhara, Alina Żabnieńska-Góra, Navid Khordehgah “Thermoelectric generator(TEG) technologies and applications ” International Journal of Thermo fluids (2021) 100063 2021



INTERNATIONAL
STANDARD
SERIAL
NUMBER
INDIA



INTERNATIONAL JOURNAL OF INNOVATIVE RESEARCH

IN SCIENCE | ENGINEERING | TECHNOLOGY

 9940 572 462  6381 907 438  ijirset@gmail.com



www.ijirset.com

Scan to save the contact details