

Development of a Low Cost ECG Data Acquisition Module

Deboleena Sadhukhan¹, Rohit Mitra², Avik Kundu², Madhuchhanda Mitra³

Research Scholar, Department of Applied Physics, University of Calcutta, Kolkata, West Bengal, India¹

M.Tech Student, Department of Applied Physics, University of Calcutta, Kolkata, West Bengal, India²

Associate Professor, Department of Applied Physics, University of Calcutta, Kolkata, West Bengal, India³

ABSTRACT: The paper describes the development of a low cost and simple amplifier circuit for ECG acquisition from a single lead. The acquisition circuit uses clip-type flat metal plate limb electrodes to sense the heart signals and a basic amplifier circuit is designed using JFET OP-AMP IC LF-353 with the required gain to suitably amplify the signal. The amplified data fed into a computer using USB-6009 is then denoised, processed and displayed using LabVIEW software. The developed ECG acquisition module is evaluated by visual comparison of simultaneously recorded data acquired by the module with and by the MP-150 amplifier system from BIOPAC Systems Inc. Tests have been performed in the laboratory on several volunteers in the age group of 28-60 and the results were quiet satisfactory.

KEYWORDS: ECG acquisition, instrumentation amplifier, LabVIEW software, filtering.

I.INTRODUCTION

The electrocardiogram (ECG) is the recording of the electrical activity of the myocardium of the heart during one cardiac cycle and is characterized by a recurrent sequence of P, QRS, T and a conditional U wave [1]. The electrical impulses within the heart act as a source of voltage, which generates a current flow in the torso and corresponding potentials on the skin. ECG is recorded by placing electrodes on the body surface and a standard 12 lead system is used to get an overall view of the heart's activity [2]. The most prevalent and significant among these is Lead II for diagnosing rhythm problems. Signals from Lead II measure the variations in potential between the right arm and the left leg, with the electrode of the left arm acting as the ground.

Cardiovascular diseases are one of the predominant causes of death, all over the world. ECG is used as an important diagnostic tool for various cardiac diseases due to its ability to correlate the different ECG wave signatures with the actual operation of the heart and its ease of recording in a non-invasive manner. Hence development of EKG acquisition hardware has impacted the progression of research in electrophysiology. Design of different amplifier circuits suitable for ECG acquisition has been proposed in literature [3-6]. Several researches have been done for development of wireless ECG acquisition module also [7, 8]. The main advantage of the wireless measurement technology is the increased patients' mobility, degree of freedom and convenience since it is not restricted by lead wires. But most of them are not cost effective and involve complex circuitry. Presently, different ECG acquisition devices are commercially available, but most of them are highly priced due to the use of inbuilt isolation and filter circuits. But in India a vast majority of the country belongs to the rural areas. Hence there is an immense need for development of a low-cost indigenous ECG acquisition system.

In this paper we propose a low cost and simple acquisition circuitry for ECG data acquisition from a single lead as shown in Fig. 1. Signal from the clip-type flat metal plate limb electrodes is suitably amplified using a simple instrumentation amplifier circuit designed with high input impedance JFET OP-AMP ICS. No separate isolation and hardware filtering has been used to avoid circuit complexity and signal distortion due to use of additional components. The amplified signal is then fed into a PC using USB-6009. The raw signal is then processed and displayed on the monitor using LabVIEW software and also stored for future analysis.

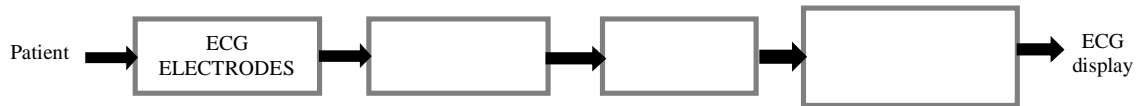

Fig. 1 Block diagram of the proposed ECG acquisition module

II.HARDWARE DESCRIPTION

The hardware part of the module consists of the ECG sensors or the electrodes, the amplifier circuit with suitable characteristics, power supply for the amplifier and an USB module for data transmission to the computer. For recording of ECG signal, the standard 12-Lead electrode configuration is commonly used which measures the potential at the frontal plane and the transverse plane of the body. The standard limb leads comprising of Lead-1, Lead-2 and Lead-3 [2] are the basic measuring leads. The leads measure potentials at one part of the body with respect to another part and hence do not require any reference electrode (Wilson Central Terminal), as needed in Augment Unipolar Leads or Unipolar Chest Leads.

A. ECG Electrodes

In order to measure and record potentials, it is necessary to provide some interface between the body and the electronic measuring apparatus. Bio-potential electrodes serve as this interface which acts as a transduction section thus converting the ionic currents in the body to electronic currents at the metal-electrolyte interface. These transducers, known as bare-metal or recessed electrodes, generally consist of a metal such as silver or stainless steel, with a jelly electrolyte that contains chloride and other ions. A clip-attached system flat metal plate electrode is used instead of disposable foam-pad electrodes due to their cost effectiveness and adaptability for continuous usage over longer periods.

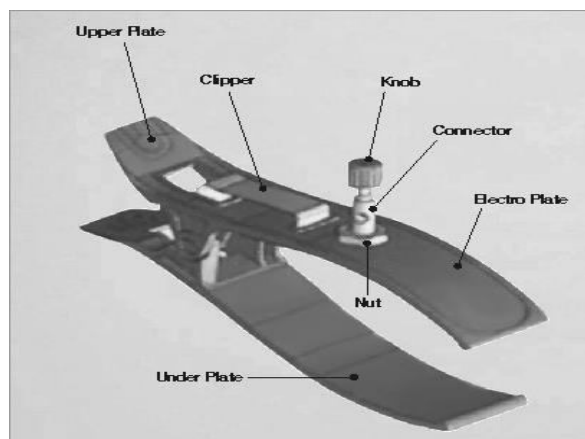

Fig. 2. Clip type flat metal plate electrodes

B. Amplifier circuit

The amplifier circuit for ECG measurement must be able to deal with the extremely weak nature of the signal of the order of few microvolts and also its low drive. The requirements for a typical ECG amplifier [2] include the following-

- Capability to sense low amplitude signals in the range of 0.05 – 10 mV
- Very high input impedance, > 5 Mega-ohms
- Very low input leakage current, < 1 micro-Amp
- Flat frequency response of 0.05 – 150 Hz

• High Common Mode Rejection Ratio

To meet all the specifications JFET OP-AMP IC LF-353 was chosen. Additionally, it is extremely low priced as compared to the other commonly used biomedical instrumentation amplifier ICs and its low input bias current range provides the basic isolation between patient's body and the electronic components and thus eliminates the need of separate isolation for the limb leads.

High common mode rejection ratio (CMRR) and low-input voltage noise are two of the most desirable features for bio-potential amplifiers in order to, respectively, reject external interference and enable high-resolution measurements. High common mode input impedance is also desirable in order to achieve a high CMRR despite the electrode's impedance mismatch [4]. All these objectives are easily achieved by using a high-gain instrumentation amplifier circuit as shown in Fig. 3.

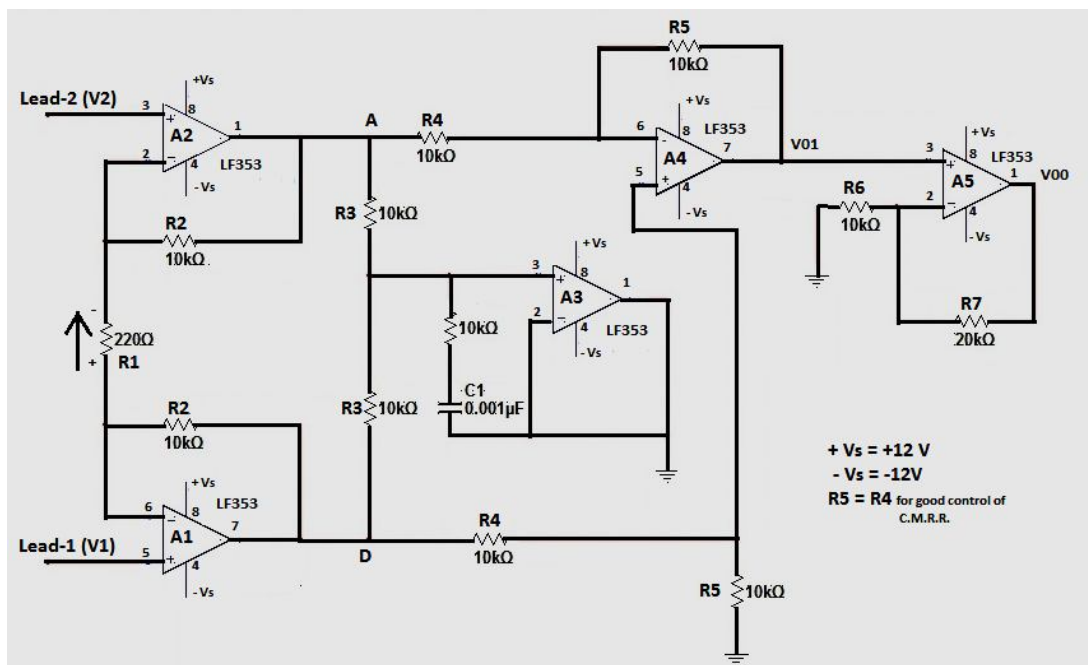

Fig. 3. Circuit diagram of the amplifier circuit

The inputs are buffered or isolated using the voltage followers. The second stage is the differential amplifier providing the necessary gain. A final non-inverting amplifier stage is added to provide the required additional gain.

The common mode voltage available at the point "A" is further minimized by using an Op-AMP A3. The D.C. components in the common-mode signal are blocked by the capacitor while the A.C. components are grounded using the negative feedback concept. The common mode point "A" can also be used to implement a Right Leg Drive circuit for augmentation in the removal of common mode signals and also ensuring patient safety. A non-inverting amplifier is also used after op-amp A4 for further enhancement of the amplified signal derived from the Instrumentation Amplifier block.

Gain of the Instrumentation Amplifier block only is given by:-

$$Av1 = V01 / (V1 - V2) = (1 + 2 R2 / R1) (R5 / R4).$$

Gain of the Non-Inverting Amplifier (N.I.) is given by

$$Av2 = (1 + R7 / R6)$$

Therefore, total gain of the amplifier circuit is given as:-

$$Av = Av1 * Av2 = (1 + 2 R2 / R1) (R5 / R4) (1 + R7 / R6)$$

We choose a gain of 90 for Instrumentation Amplifier part comprising of op-amps A1, A2, A3 and A4 and a value of 10 kilo ohm (standard value) for R2. Keeping R5=R4=R2 for good control over C.M.R.R., the value of R1 can be

derived as 224.71ohm but unfortunately this is not a standard value. We use R1 = 220ohm (standard resistor value with +/- 1% tolerance) and this gives a gain of approximately $A_{v1} = 92$. For Non-Inverting Amplifier R6 and R7 are chosen as 10K and 20K respectively and this gives a gain of $A_{v2} = 3$. Therefore, total gain of the amplifier circuit is $A_v = 92 * 3 = 276$. The gain is sufficient to suitably amplify the ECG signals for different heart abnormalities like Hyperkalemia which has high T-wave amplitudes and small or indiscernible P-waves used by excess potassium in the body. No separate isolation and hardware filtering has been used to avoid circuit complexity and signal distortion due to use of additional components

The circuit is fabricated on a bread board and powered from a standard +/- 12V regulated power supply as shown in Fig.4. The amplified ECG signal from the amplifier circuit is then fed into a PC using USB-6009 made by National Instruments.

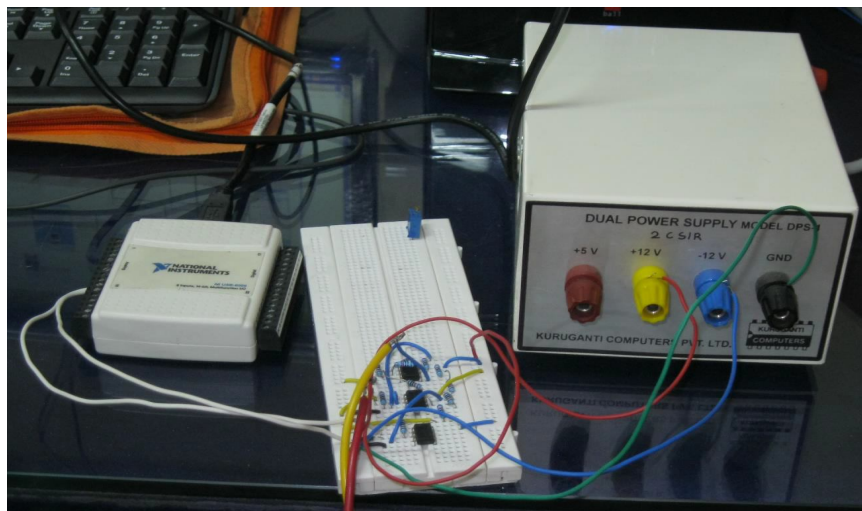

Fig.4. Fabricated hardware

III. SOFTWARE DESCRIPTION FOR ECG PROCESSING & DISPLAY

LabVIEW, shortform for Laboratory Virtual Instrument Engineering Workbench, is a programming environment in which programs can be created using a graphical notation (connecting functional nodes via wires through which data flows). A program is made for preliminary level processing of the acquired raw data and displaying it on the computer screen and also storing the records for future analysis. The block diagram and the front panel are shown in Fig. 7 and Fig. 8, respectively.

A. Programming for ECG Data Acquisition

The configuration of the data acquisition from USB-6009 module is done by using the DAQ ASSISTANT function which is a graphical interface that is used to configure the measurement tasks (configured through MAX) and channels on the DAQ card.

For a NI USB 6009 having a 14-bit resolution ADC, we select a sampling frequency much more than the Nyquist sampling frequency. Since the ECG signal is a bipolar signal, the input voltage is selected to be +/-10 V that gives a total range of 20 Volts. This is done because the maximum amplitude in the ECG signal is that of R-peak with a value of 1.60mV and the smallest detectable change in the input voltage called the code width (V_{cw}) is then given as

$$V_{cw} = \frac{I/P \text{ Voltage Range}}{2^{\text{RESOLUTION}}} = \frac{20}{2^{14}} = 1.2\text{mV i.e. sufficient to detect R-Peak.}$$

The “terminal” configuration parameter is selected to be “differential” since an ideal differential measurement system reads only the potential difference between its two terminals- the (+) and the (-) inputs. It completely rejects any voltage present at the instrumentation amplifier inputs with respect to the amplifier ground. In other words, an ideal differential measurement system completely rejects the common mode voltage.

The acquisition time can also be fixed according to the user requirement.

B. Programming for ECG Filtering

ECG signals are routinely contaminated by noise due to motion artefacts, power line noise, and electrode contact noises, all of which decreases the accuracy of ECG interpretation. The goal of ECG filtering is to separate the valid cardiac components from the background noises so as to obtain a signal that is qualified for reliable interpretation. Different kinds of digital filters have been used in literature for ECG filtering [9,10].

The main source of artefact in the acquired ECG signal displayed on the LabVIEW front panel was Power Line Interference and slow base-line wandering and some high frequency components.

In India, the power line frequency is 50 Hz. So an IIR band stop filter in the frequency range of 48Hz to 52Hz with a much higher order and Butterworth topology is used for power line removal as shown in the Fig. 5.

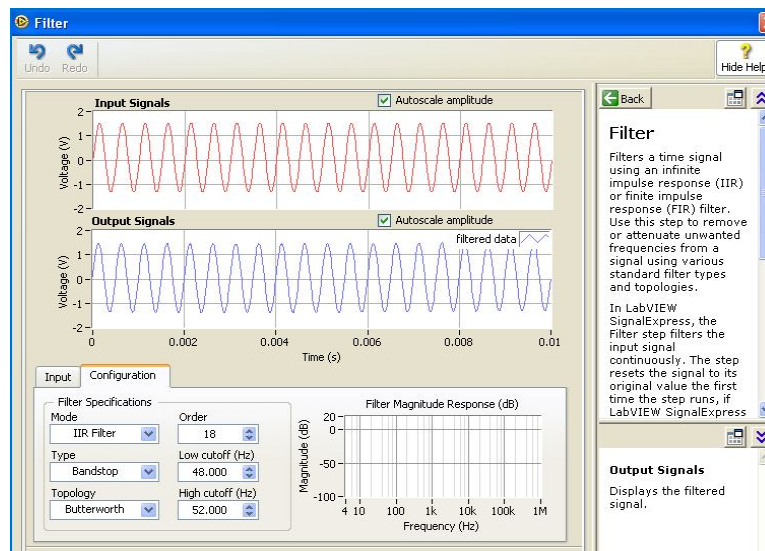

Fig. 5. Bandstop filter configuration for power line noise removal

The high frequency components were removed by a Moving Average (Smoothing) Filter. It is probably the most optimal smoothing filter in the time domain but an exceptionally bad low-pass filter in the frequency domain with the roll-off very slow and stop-band attenuation ghastly. Clearly, the moving average filter cannot separate one band of frequencies from another but for signals buried in random noise, the smoothing action of moving average filter is very good but it reduces the sharpness of the edges as well.

Multiple-pass moving average filters involve passing the input signal through a moving average filter two or more times. Two passes are equivalent to using a triangular filter kernel which is better than a rectangular filter kernel as a triangular filter kernel is a rectangular filter kernel convolved with itself, therefore the same is used in our case too. Fig-6 shows the configuration settings for the moving average filter.

The following Fig. 7 and Fig. 8 shows the complete block diagram programming and the corresponding ECG display on the front panel of the LabVIEW. The filtered ECG data is also stored in measurement files for future analysis and display. The storage file can be specified by the user.

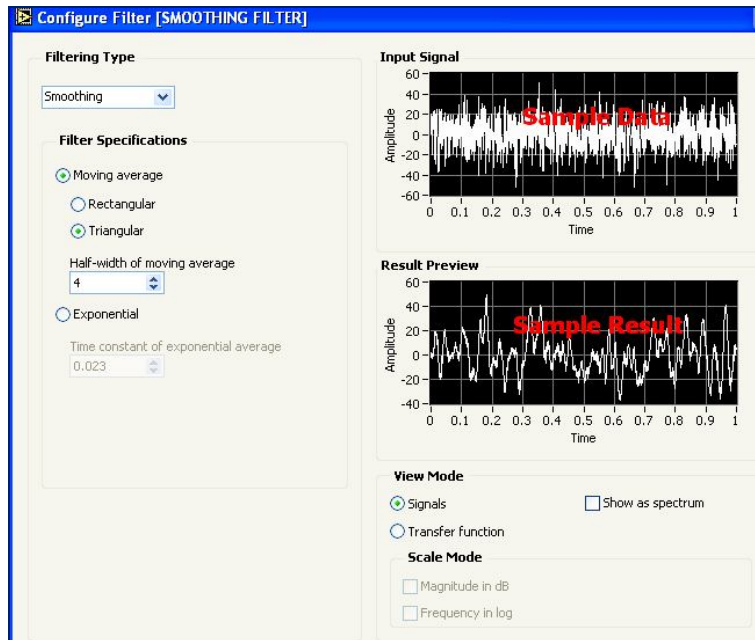

Fig. 6. Smoothing filter configuration for high frequency removal

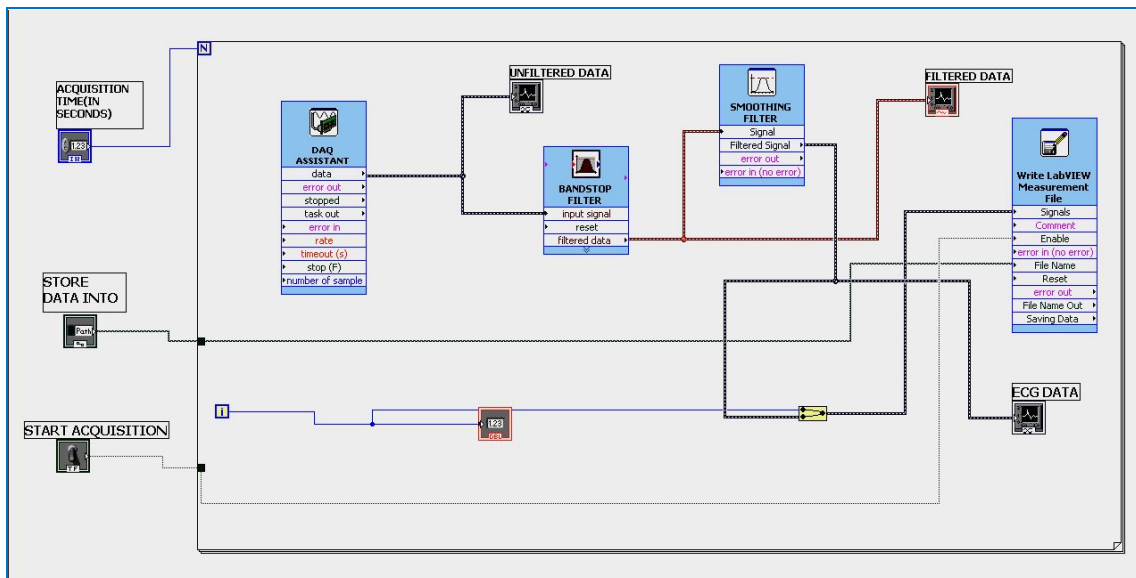

Fig. 7. Overall block diagram for ECG filtering and display

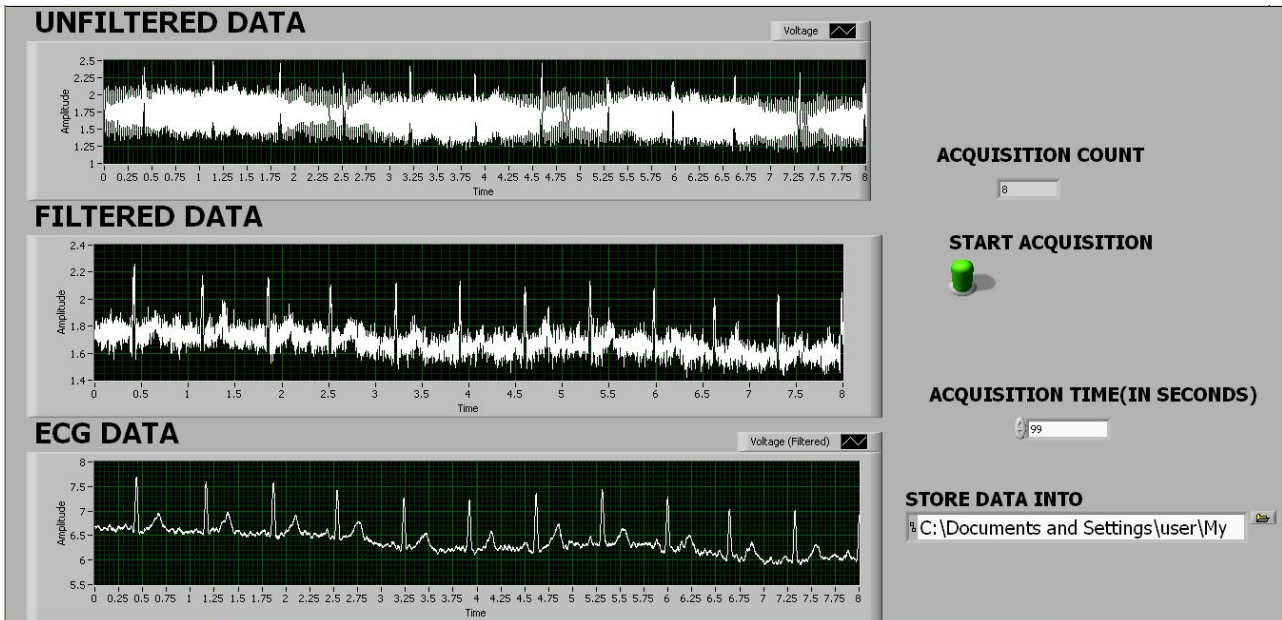

Fig. 8. ECG display on the LabVIEW front panel

IV. EXPERIMENTAL RESULTS

The developed ECG acquisition module is tested in the laboratory to acquired leadII ECG data from several volunteers in the age group of 28-60, both male and female. Fig 9 shows the complete experimental set up. Performance evaluation of the developed module is performed by visual comparison of simultaneously recorded data acquired by the module and by the MP-150 amplifier system from BIOPAC Systems Inc. A few of the visual comparison test results plotted in Matlab 7.1 are shown in Fig 10.

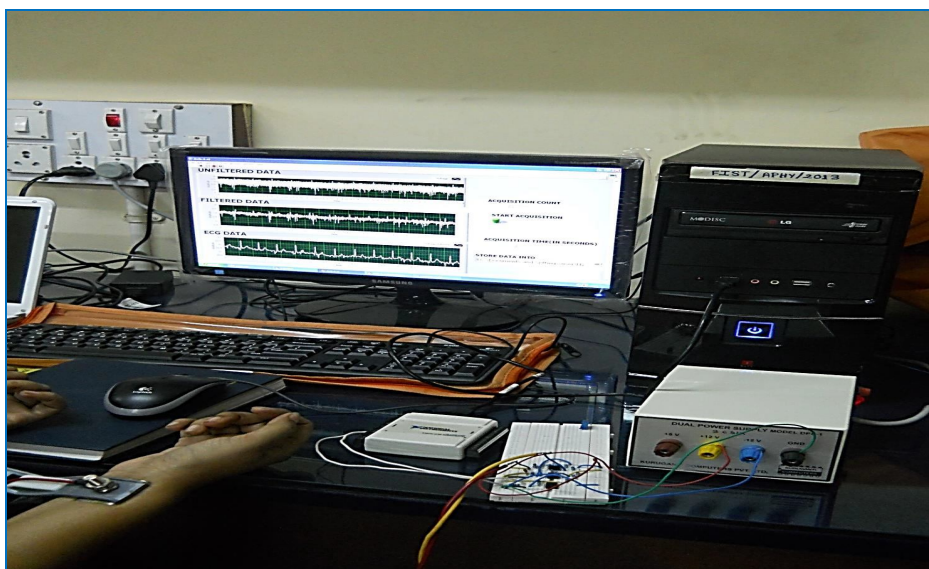

Fig.9. Overall experimental setup

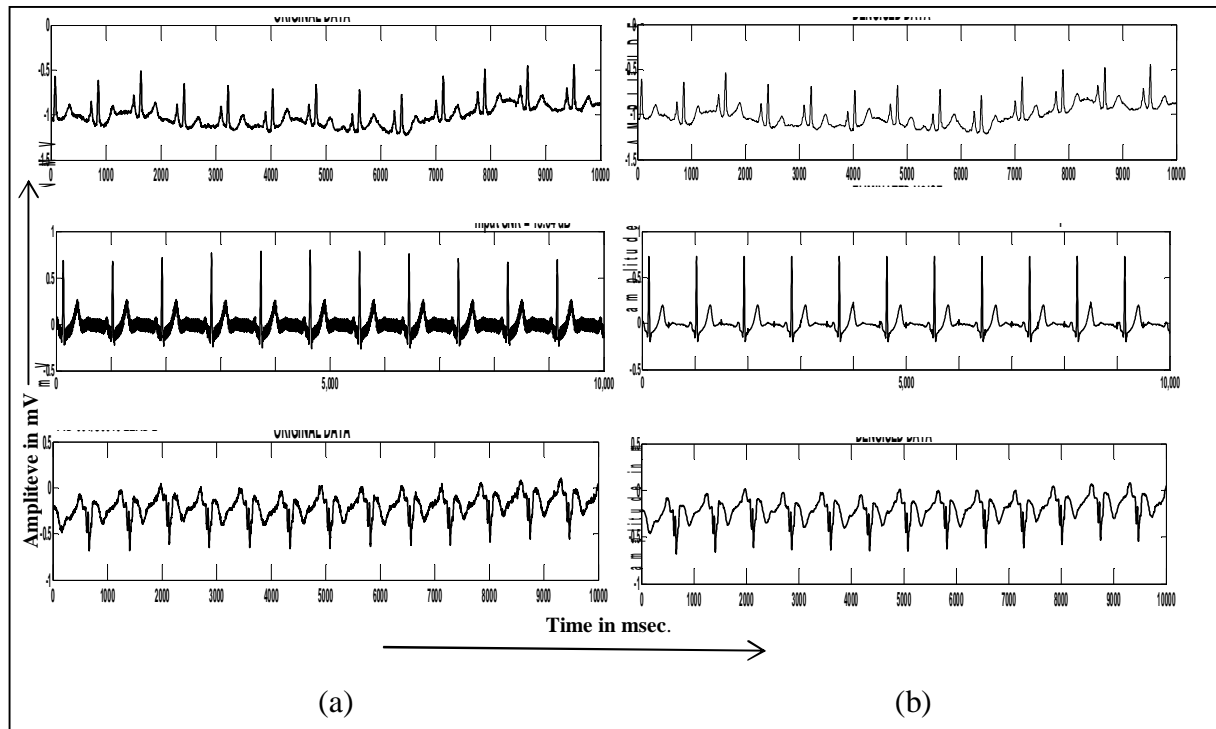

Fig. 10. Visual comparison test results a) Data recorded by MP-150 system by Biopac b) Simultaneous data recorded by the developed acquisition module

The test results reveal quiet a satisfactory performance of the developed module. As shown in the fig. 10, the different ECG waveforms were well acquired by the module. The wave signatures of the ECG beats were well correlated in both the data sets. However, due to the use of filtering in the developed module, the amount of noise present in the data varied. Also, acquisition of chest lead ECG has been purposely avoided to ensure patient safety.

IV. CONCLUSION

The performance of the developed module was quiet satisfactory. The acquisition circuitry does not involve any costly components and hence is very cheap and simple as compared to the other commercial ECG acquisition modules. However, as the acquisition circuitry does not use any separate isolation, it is not suitable to use it for acquisition of chest lead ECG, too ensure patient safety.

Some modifications still need to be incorporated for performance enhancement of the circuit. Like, making the circuit battery powered will make the circuit indigenous and also will allow more patient safety. Also, much functionality could be added to the PC program, to perform direct ECG analysis and disease identification.

REFERENCES

1. L. Schamroth, *An Introduction to Electrocardiography*, 7th ed. Oxford: Blackwell Science ltd; 1990.
2. J. D. Bronzio, *The Biomedical Engineering Handbook*, IEEE Press, 2000.
3. M.S.J.Steyaert, W.C.Sansen, C.Zhongyuan, "A Micro-power low noise Monolithic Instrumentation Amplifier for Medical purposes", IEEE Journal of Solid state circuits", 1987, SC-22(6) , pp 1163-1168
4. E.M. Spinelli, N. Martínez, M. A. Mayosky, R.P. Areny, "Novel Fully Differential Biopotential Amplifier With DC Suppression" , IEEE Transactions on BME, Vol. 51, no. 8, 2004
5. M.J. Burke, D.T. Gleeson, "A micropower dry electrode ECG Pre-amplifier" IEEE Transaction on Biomedical Engineering, 2000, vol.- 47 (2) 155-162

International Journal of Innovative Research in Science, Engineering and Technology

An ISO 3297: 2007 Certified Organization, Volume3, Special Issue 6, February 2014

National Conference on Emerging Technology and Applied Sciences-2014 (NCETAS 2014)

On 15th to 16th February, Organized by

Modern Institute of Engineering and Technology, Bandel, Hooghly 712123, West Bengal, India.

6. C.J. Yen, W.Y. Chung, M.C. Chi, "Micro-power low offset Instrumentation Amplifier IC design for biomedical system applications", IEEE Transactions on Circuits and Systems, 2004, vol- 51(4), pp. 691-699.
7. M. Chaitanya Suman and K. Prathyusha, " Wireless ECG System Based on ARM LPC 2103 Processor", IJECT Vol. 3, Issue 1, Jan.-March 2012
8. E.S. Valchinov and N.E. Pallikarakis , "Wearable Wireless Biopotential Electrode for ECG Monitoring", IFMBE Proceedings 16, pp. 373–376, 2007.
9. J. A Van Alste., , T. S. Schilder, "Removal of Baseline Wander and Power-Line Interference from the ECG by an Efficient FIR Filter with a Reduced Number of Taps", IEEE Transactions on Biomedical Engineering, BME-32 , issue 12, 1985, pp. 1052-1060.
10. Y. Sun, K.L. Chan, and S.M. Krishnan, "ECG signal conditioning by morphological filtering". Computers in biology and medicine, 32(6): 465-479, 2000.

BIOGRAPHY



Deboleena Sadhukhan is currently pursuing her Ph.D. from the Department of Applied Physics, University of Calcutta. After graduating with Physics Hons., she did her B.Tech and M.tech in Instrumentation Engineering from the Department of Applied Physics, University of Calcutta and stood First class First from the university in both. She also has a one year teaching experience in a reputed engineering college and also served as Guest Lecturer in the Department of Applied Physics, University of Calcutta. Her research interest is Biomedical signal processing.

[1] She has currently been awarded the DST-INSPIRE fellowship.



Rohit Mitra is pursuing M.Tech in Instrumentation and Control Engineering in the Department of Applied Physics, Calcutta University and have appeared for the 5th Semester examination. He have passed B.Tech under West Bengal University of Technology (WBUT) in the year 2009 in Electronics and Instrumentation Engineering.



Avik Kundu Mitra is pursuing M.Tech in Instrumentation and Control Engineering in the Department of Applied Physics, Calcutta University and have appeared for the 5th Semester examination. He completed B. Tech in Electronics and Instrumentation Engineering from Future Institute of Engineering and Management in 2011.