

International Journal of Innovative Research in Science, Engineering and Technology

(An ISO 3297: 2007 Certified Organization)

Vol. 4, Special Issue 13, December 2015

Design and Fabrication of Composite Gears

K.Krishnakanth¹, E.R.Sivakumar²

Assistant Professor, Dept. of EEE, Sasurie College of Engineering, Tiruppur, Tamilnadu, India^{1&2}

ABSTRACT: A new design method for polymer composite gear has been proposed in the current paper. This design method is based on the link between polymer gear wear rate and its surface temperature. It has been found from the tests that the polymer (acetal) gear wear rate will be increased dramatically when the load reaches a critical value for a specific geometry. The gear surface will wear slowly with a low specific wear rate if the gear is loaded below the critical one. The possible reason of the sudden increase in wear rate is due to the gear operating temperature reaching the material melting point under the critical load condition. Gear surface temperature has been then investigated in detail through three components: ambient, bulk and flash temperatures. Through extensive experimental investigations and modelling on gear surface temperature variations, a general relation has been built up between gear surface temperature and gear load capacity. The method has been related to test results under different operating ambient temperature and gear geometries. Good agreement has been achieved between the proposed method predictions and experimental test results. Experimental investigation on polymer composite (glass fibre reinforced nylon with PTFE as internal lubricant) gears have also been carried out and two forms of failure have been found, root and pitch fractures.

KEYWORDS: Wear rate, Polymer composite gear, Gear surface temperature, Gear mesh and contact path

I. INTRODUCTION

Composite materials, often shortened to composites or called composition materials, are engineered or naturally occurring materials made from two or more constituent materials with significantly different physical or chemical properties which remain separate and distinct within the finished structure. Composites are made up of individual materials referred to as constituent materials. There are two categories of constituent materials: matrix and reinforcement. At least one portion of each type is required. The matrix material surrounds and supports the reinforcement materials by maintaining their relative positions. The reinforcements impart their special mechanical and physical properties to enhance the matrix properties. Polymer composite materials exhibit excellent strength and stiffness in combination with low density. These properties are especially attractive in structures where transport of goods and people using non-renewable fuels are utilized. Decreased weight with equal transport capacity lowers the total cost and fuel consumption. For several years now glass fiber composites have been used in products such as containers, pleasure boats and automotive parts. Traditionally carbon and aramid fiber composites are utilized in more demanding applications like aircraft and aerospace industry.

II. MATERIALS

MATERIALS CHOSEN

The following materials were chosen for the study purpose. **Material:** PEEK + Sic + with internal lubricant as PTFE.

PROPERTIES OF PEEK

PEEK is high temperature resistant engineered thermoplastic with excellent chemical and fatigue resistance plus thermal stability. They exhibit superior mechanical and electrical properties. With a maximum continuous working temperature of 250 ° C, they have excellent retention of mechanical properties up to 300° C in a steam or high-pressure water environment. Superior chemical resistance has allowed them to work effectively as a metal replacement in harsh environments. They are inert to all common solvents and resist a wide range of organic and inorganic liquids. When

International Journal of Innovative Research in Science, Engineering and Technology

(An ISO 3297: 2007 Certified Organization)

Vol. 4, Special Issue 13, December 2015

extensive machining is required, a secondary annealing process should be considered. PEEK, a unique semi-crystalline, high temperature engineering thermoplastic, is an excellent material for a wide spectrum of applications where thermal, chemical, and combustion properties are critical to performance. Especially significant, in this regard, is PEEK's ability to retain flexural and tensile properties at very high temperatures in excess of 250°C (482°F). The addition of glass fiber and carbon fiber reinforcements enhances the mechanical and thermal properties of the basic PEEK material.

III. GRADES OF PEEK

PEEK (Unfilled)

This general purpose grade is unreinforced and offers the highest elongation and toughness of all PEEK grades. Unfilled PEEK is available in sheet and rod forms and is also available in black. Black PEEK is ideal for instrument components where aesthetics are important, as well as for seal components where ductility and inertness are important.

PEEK (30% Glass Filled)

The addition of glass fibers significantly reduces the expansion rate and increases the flexural modulus of PEEK. This grade is ideal for structural applications that require improved strength, stiffness, or stability, especially at temperatures above 300°F (150°C). Glass-filled PEEK is light brown or tan in colour and mostly used for injection moulding.

PEEK (30% Carbon Filled)

The addition of carbon fibers enhances the compressive strength and stiffness of PEEK, and dramatically lowers its expansion rate. It offers designers optimum wear resistance and load carrying capability in a PEEK-based product. This grade provides 3½ times higher thermal conductivity than unreinforced PEEK dissipating heat from the bearing surface faster.

PEEK (Bearing Grade, Ketrion HPV)

This grade of PEEK, containing carbon fiber reinforced with graphite and PTFE lubricants, offers the lowest coefficient of friction and the best machinability for all PEEK grades. Bearing grade PEEK has an excellent combination of low friction, low wear, high limiting PV, low mating part wear, and easy machining. Bearing grade PEEK is black or dark grey in colour. Of the above grades of PEEK due to availability concerns in INDIA, 30% carbon filled grade was selected and purchased.

POLYTETRAFLUOROETHYLENE (PTFE)

Polytetrafluoroethylene (PTFE) is a synthetic fluoropolymer of tetrafluoroethylene that finds numerous applications. The best known brand name of PTFE is Teflon by DuPont Co. PTFE is a fluorocarbon solid, as it is a high-molecular-weight compound consisting wholly of carbon and fluorine. PTFE is hydrophobic: neither water nor water-containing substances wet PTFE, as fluorocarbons demonstrate mitigated London dispersion forces due to the high electro negativity of fluorine. PTFE has one of the lowest coefficients of friction against any solid. PTFE is used as a non-stick coating for pans and other cookware. It is very non-reactive, partly because of the strength of carbon-fluorine bonds, and so it is often used in containers and pipe work for reactive and corrosive chemicals. Where used as a lubricant, PTFE reduces friction, wear, and energy consumption of machinery.

CALCULATION OF GEAR TOOTH PARAMETERS

Number of teeth	$Z_1 = 50$
Total height of a gear tooth,	$h = 2.25m = 3 \text{ mm}$
Module,	$m = 3/2.25 = 1.33 \text{ mm}$
Pitch circle diameter	$d_1 = m.Z_1 = 1.33*50$
$d_1 = 66.5 \text{ mm}$	
Addendum,	$h_a = m$
$h_a = 1.33 \text{ mm}$	

International Journal of Innovative Research in Science, Engineering and Technology

(An ISO 3297: 2007 Certified Organization)

Vol. 4, Special Issue 13, December 2015

Dedendum,
hf = 1.67 mm

$$hf = 1.25 * m$$

IV. ANALYSIS OF INJECTION MOULDING PROCESS

Injection molding may be a simple process but care has to be taken when it comes to die design and manufacture to make sure that the component produced from it has minimal defects. In the case of injection molding, location of sprue is very important. It determines the number of defects such as air traps, weld lines etc. In olden days the location of sprue was finalized either by trial and error method or out of sheer experience in the field. Nowadays with the development of technology many software are available to roughly predict the process out comes by properly feeding the data of the problem or process under study.

The software “MOLDFLOW PLASTICS INSIGHT V 3.1” is used to analysis the injection molding process and using the results obtained the optimum location of the sprue can be got.

STEPS INVOLVED IN ANALYSIS

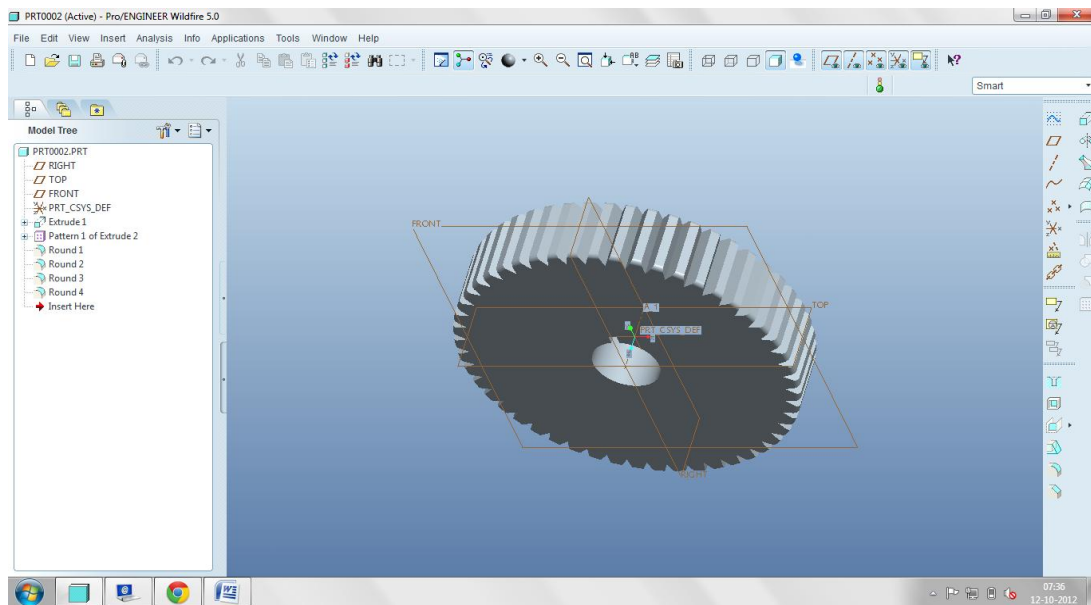

Fig 1 3D cad model of gear using PRO E

The following steps are to be followed to analyze the injection molding process using “MOLDFLOW PLASTICS INSIGHT V 3.1”.

- Development of the CAD model of the component using a 3D CAD software. So PRO E is used to model the CAD model of the gear as shown in fig 5.1.
- After completing the modeling it has to be saved in .stl file format because the MOLDFLOW software cannot access .cat or .prt files.
- Then the MOLDFLOW software is opened and new project directory is created in the name “Gear analysis”.
- Then the gear’s 3D model is imported to the MOLDFLOW software and meshed using standard 3D fusion elements as shown in fig 5.2.

International Journal of Innovative Research in Science, Engineering and Technology

(An ISO 3297: 2007 Certified Organization)

Vol. 4, Special Issue 13, December 2015

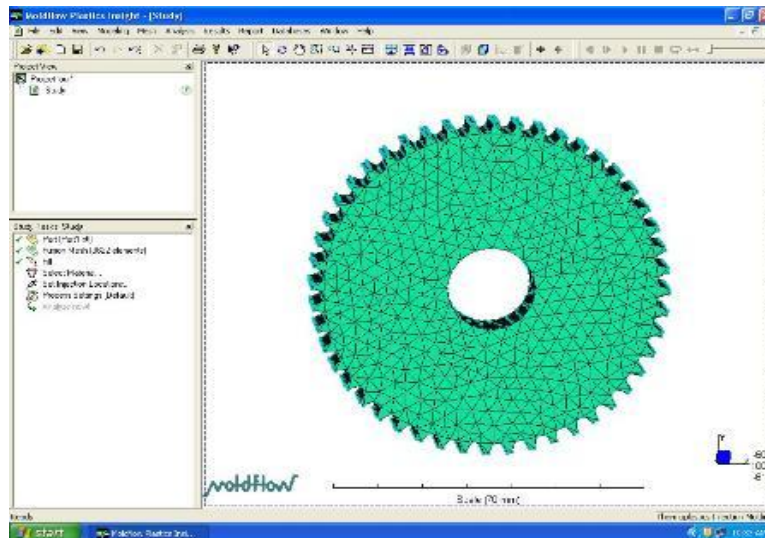

Fig2 Meshed gear model in mold flow plastics insight

- Next the gear material is selected. Here one of the study materials VICTREX PEEK supplied by DuPont polymers is used.

MACHINE PARAMETERS

Maximum machine clamp force	= 7.0000 x 10 ³ tone
Maximum injection volume	= 2.0000 x 10 ⁴ cm ³
Maximum injection pressure	= 1.0000 x 10 ² MPa
Maximum machine injection rate	= 5.0000 x 10 ³ cm ³ /s

PROCESS PARAMETERS

Fill time	= 40.0000 s
Cooling time	= 20.0000 s
Packing/holding time	= 10.0000 s

- Next the injection location is marked using the injection point selection option. Here two positions were considered,

1. on the gear tooth
2. on the gear face.

Since the component is axisymmetrical any two locations will serve the purpose.

- Once all the settings are finished and parameters are given the analysis is made to run and the software runs the simulation and produces the results in few minutes.

V. ANALYSIS OF THE RESULTS

From the results produced few important factors like the weld lines air traps fill time pressure required etc were considered to decide on the final location of the sprue out of the two suggested locations.

International Journal of Innovative Research in Science, Engineering and Technology

(An ISO 3297: 2007 Certified Organization)

Vol. 4, Special Issue 13, December 2015

AIR TRAPS

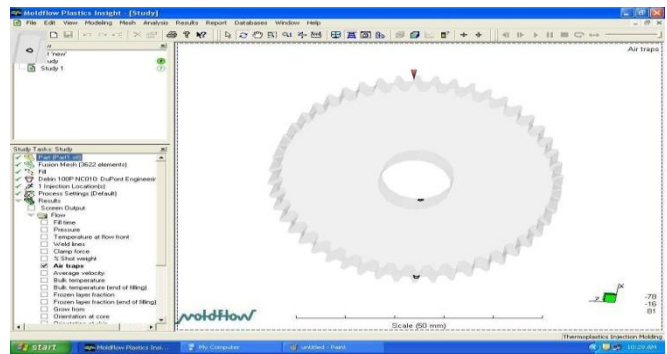
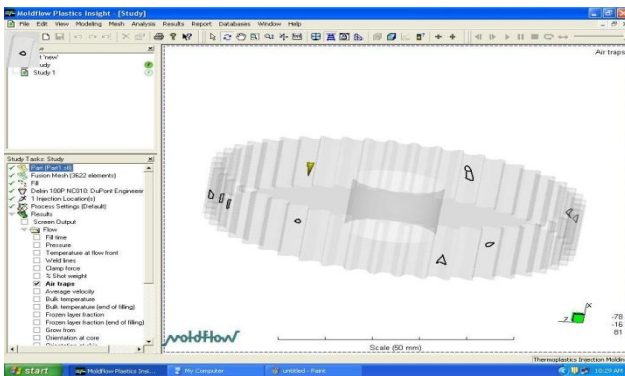

Fig3 Analysis showing air traps at location 1 Fig 4 Analysis showing air traps at location 2

The figures 5.3 and 5.4 above shows the possible locations of air trap formation as per the simulation of mold flow plastics software.

From the simulation it can be seen that the number of air traps formed when the sprue is placed in location 1 i.e. on the gear face is more than on the location 2 i.e. on the gear tooth.

Hence the location 2 seems to be better in this result as the number of air traps seems to be less and will produce a defect free gear.

Weld lines

Weld lines are also important as they reduce the strength of the component just as the air traps does.

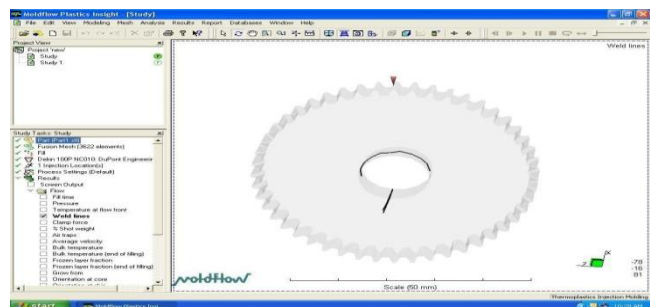
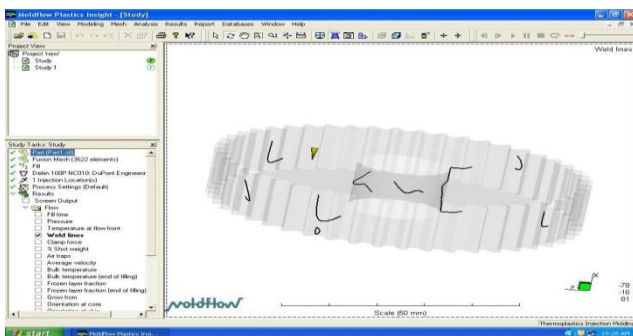

Fig 5 Analysis showing weld lines at location 1

Fig6 Analysis showing weld lines at location 2

The figures 5 and 6 above shows the possible locations of weld lines formation as per the simulation of mould flow plastics software.

From the simulation it can be seen that the number of weld lines formed while the sprue is placed in location 1 i.e. on the gear face is more than on the location 2 i.e. gear tooth.

Hence the location 2 seems to be better in this result as well as the number of weld lines seems to be less and will produce a defect free and strong gear.

International Journal of Innovative Research in Science, Engineering and Technology

(An ISO 3297: 2007 Certified Organization)

Vol. 4, Special Issue 13, December 2015

Fill time

The fill time is a very important factor because it is not only related to the sprue location but also determines the productivity of the component.

The figures 7 and 8 shows the time required to fill the die cavity. Location 1 takes about 41.76 seconds to fill the cavity while location 2 takes only 36.33 seconds to fill the cavity. Again location 2 which is on the gear tooth seems to be a perfect location for the sprue as it produces gear in a quick time hence will be better productive than the location 1.

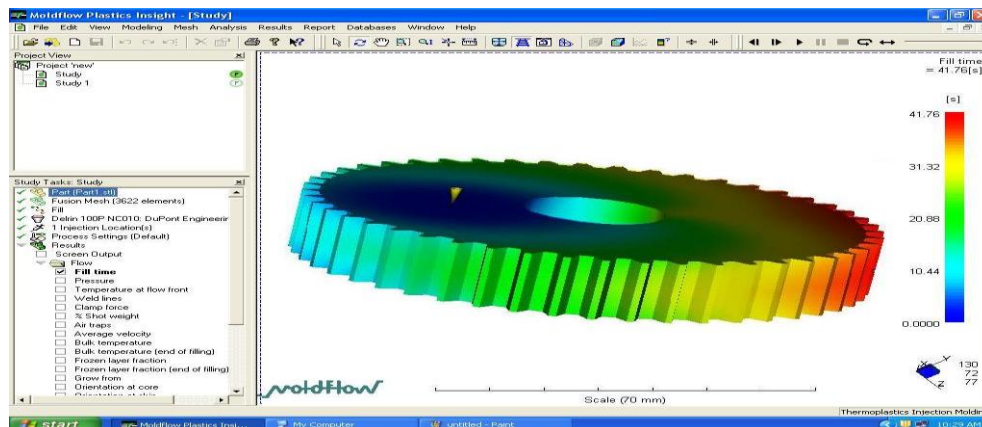

Fig 7 Analysis showing various parts of the die cavity being filled gradually in 41.76 sec at location 1

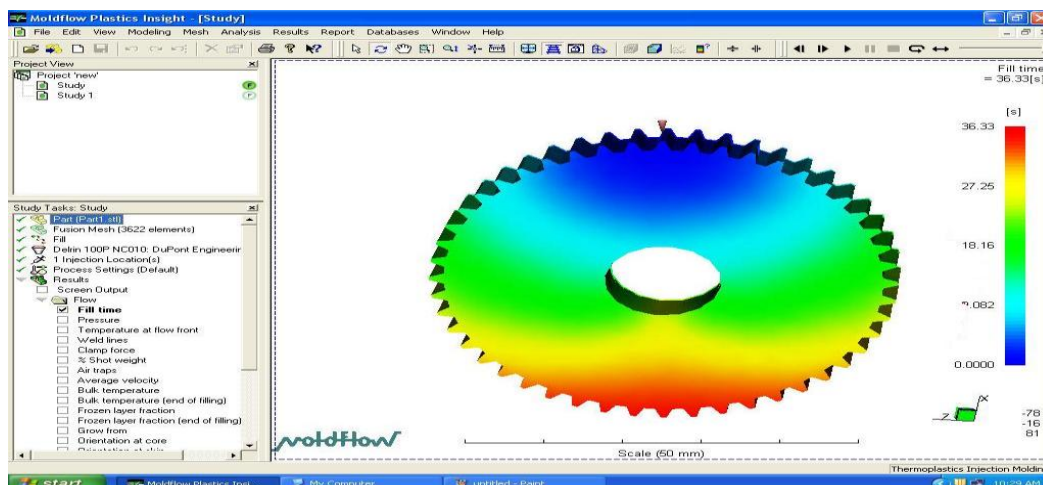

Fig 8 Analysis showing various parts of the die cavity being filled gradually in 36.33 sec at location 2

Inference from the results

From the above discussed results of the simulation it is clear that location 2 i.e. on the tooth will be ideal location for placing the sprue.

Hence it was decided to keep the sprue location on the tooth of the gear during the die manufacturing.

International Journal of Innovative Research in Science, Engineering and Technology

(An ISO 3297: 2007 Certified Organization)

Vol. 4, Special Issue 13, December 2015

VI. MANUFACTURE OF COMPOSITE POLYMER GEARS

GEAR MATERIALS

Polymer material VICTREX PEEK CA30 was chosen to make a comparative study between the performance and other characteristics of the polymer gears made out of them. This material was mixed with silicon carbide (Sic) powder as a reinforcement to form the polymer composite. Three sets of polymer composite gears were manufactured by adding Sic powder in different proportions. This was done in order to diversify the verification of their performance and to see whether higher concentration of reinforcement in the polymer matrix reduces or increases its properties.

INJECTION MOLDING PROCESS

Injection molding is the widely used manufacturing process for producing parts made out of both thermoplastic and thermosetting plastic materials. Material is fed into a heated barrel, mixed, and forced into a mold cavity where it cools and hardens to the configuration of the mold cavity. After a product is designed, usually by an industrial designer or an engineer, molds are made by a mold maker (or toolmaker) from metal, usually either steel or aluminum, and precision-machined to form the features of the desired part. Injection molding is widely used for manufacturing a variety of parts, from the smallest component to entire body panels of cars. The process cycle for injection molding is very short, typically between 2 seconds and 2 minutes, and consists of the following four stages:

CLAMPING

Prior to the injection of the material into the mold, the two halves of the mold must first be securely closed by the clamping unit. Each half of the mold is attached to the injection molding machine and one half is allowed to slide. The hydraulically powered clamping unit pushes the mold halves together and exerts sufficient force to keep the mold securely closed while the material is being injected in. The time required to close and clamp the mold is dependent upon the machine - larger machines (those with greater clamping forces) will require more time. This time can be estimated from the dry cycle time of the machine.

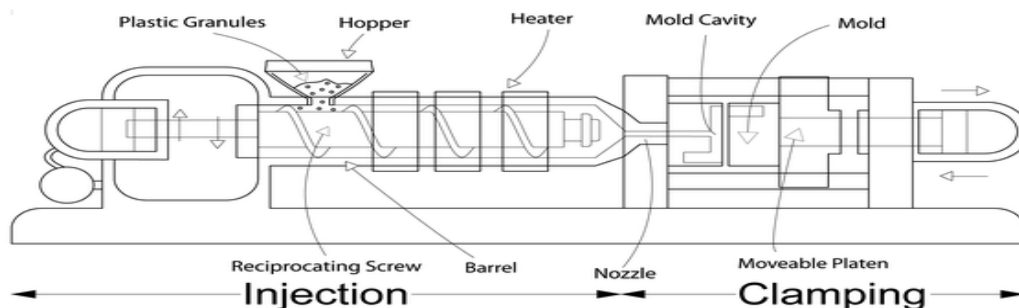

Fig 9 Injection molding machine

INJECTION

The raw plastic material, usually in the form of pellets, is fed into the injection molding machine, and advanced towards the mold by the injection unit. During this process, the material is melted by heat and pressure. The molten plastic is then injected into the mold very quickly and the buildup of pressure packs and holds the material. The amount of material that is injected is referred to as the shot. The injection time is difficult to calculate accurately due to the

International Journal of Innovative Research in Science, Engineering and Technology

(An ISO 3297: 2007 Certified Organization)

Vol. 4, Special Issue 13, December 2015

complex and changing flow of the molten plastic into the mold. However, the injection time can be estimated by the shot volume, injection pressure, and injection power.

COOLING

The molten plastic that is inside the mold begins to cool as soon as it makes contact with the interior mold surfaces. As the plastic cools, it will solidify into the shape of the desired part. However, during cooling some shrinkage of the part may occur. The packing of material in the injection stage allows additional material to flow into the mold and reduce the amount of visible shrinkage. The mold cannot be opened until the required cooling time has elapsed. The cooling time can be estimated from several thermodynamic properties of the plastic and the maximum wall thickness of the part.

EJECTION

After sufficient time has passed, the cooled part may be ejected from the mold by the ejection system, which is attached to the rear half of the mold. When the mold is opened, a mechanism is used to push the part out of the mold. Force must be applied to eject the part because during cooling the part shrinks and adheres to the mold. In order to facilitate the ejection of the part, a mold release agent can be sprayed onto the surfaces of the mold cavity prior to injection of the material. The time that is required to open the mold and eject the part can be estimated from the dry cycle time of the machine and should include time for the part to fall free of the mold. Once the part is ejected, the mold can be clamped shut for the next shot to be injected. After the injection molding cycle, some post processing is typically required. During cooling, the material in the channels of the mold will solidify attached to the part. This excess material, along with any flash that has occurred, must be trimmed from the part, typically by using cutters.

For some types of material, such as thermoplastics, the scrap material that results from this trimming can be recycled by being placed into a plastic grinder, also called regrind machines or granulators, which regrinds the scrap material into pellets. Due to some degradation of the material properties, the regrind must be mixed with raw material in the proper regrind ratio to be reused in the injection molding process. The size of a part will depend on a number of factors (material, wall thickness, shape, process etc). The initial raw material required may be measured in the form of granules, pellets or powders. Here are some ranges of the sizes used in a typical injection molding machine shown in fig 5.1.

Table 1 Common size ranges of an injection molding machine

Method	Raw Materials	Maximum Size	Minimum Size
Injection Molding (thermo-plastic)	Granules, Pellets, Powders	20 Kg	30 grams
Injection Molding (thermo-setting)	Granules, Pellets, Powders	6 Kg	30 grams

INJECTION MOLDING TIME CALCULATION

The time taken to make a product using injection molding process can be calculated by adding the below mentioned formula.

Total Time (TT) = Twice the Mold Open/Close Time (2M) + Injection Time (T) + Cooling Time (C) + Ejection Time (E)

Where T is found by dividing:
Mold Size (S) / Flow Rate (F)

Total time (TT) = 2M + T + C + E

International Journal of Innovative Research in Science, Engineering and Technology

(An ISO 3297: 2007 Certified Organization)

Vol. 4, Special Issue 13, December 2015

$$T = V/F$$

V = Mold cavity size (in³)

F = Material flow rate (in³/min)

The total cycle time can be calculated using, $T_c = T_{cl} + T_{co} + T_e$

Where T_c = Total cycle time in seconds.

T_{cl} = Closing time in seconds.

T_{co} = Cooling time in seconds.

T_e = Ejection time in seconds.

The closing and ejection times, can last from a fraction of a second to a few seconds, depending on the size of the mold and machine. The cooling times, which dominate the process, depend on the maximum thickness of the part.

GEAR COMPOSITION

MATERIAL = VICTREX PEEK POLYETHERETHERKETONE \implies

These materials are mixed with Sic and PTFE (POLYTETRAFLUROETHYLENE) which is an internal lubricant in the following ratios. Hence here the polymer is the matrix and Sic is the reinforcement.

1. Virgin polymer
2. Polymer + 20% Sic + 10% PTFE
3. Polymer + 25% Sic + 10% PTFE
4. Polymer + 30% Sic + 10% PTFE

PROCESS PARAMATERS

The process parameters used for the manufacture of the above gears through injection molding process in a hydraulically operated injection molding machine are listed below,

Nozzle temperature	: 350° C for VICTREX PEEK
Maximum machine clamp force	: 7×10^3 tones
Maximum injection volume	: 2×10^4 cm ³
Maximum injection pressure	: 1×10^2 MPa
Fill time	: 35-40 s
Cooling time	: 18-20 s
Packing/holding time	: 5-10

VII. CONCLUSION

Engineering components made of composite materials find increasing applications ranging from spacecraft to small instruments. Many types of gear pump use composite gears, however little literature is available on their use. In this project, the results are obtained by static stress analysis of composite gears using a three-dimensional finite element approach are presented. From the results it is concluded that composite material such as PEEK can be thought of as a material for power transmission gears.

Internationally patented Composite Structural Members provides slightly different engineering solution for bonding of structural inserts into composite plastic material. If Snap-on invention utilizes oriented and randomly oriented reinforced fibers for constructing the ring gear housing, the Composite Structural Members patent offers a solution for using filament winding material.

REFERENCES

1. Fundamentals of Composites Manufacturing: Materials, Methods and Applications, Second Edition by A. Brent Strong (Nov 27, 2007).
2. Essentials of Advanced Composite Fabrication and Repair by Louis C. Dorworth, Ginger L. Gardiner and Greg M. Mellema (Feb 1, 2010)
3. Concise Encyclopedia of Composite Materials, Second Edition by Andreas Mortensen (Jan 1, 2007)
4. Structural Analysis of Polymeric Composite Materials, Second Edition by M. E. Tuttle (Dec 4, 2004)



ISSN(Online) : 2319-8753
ISSN (Print) : 2347-6710

International Journal of Innovative Research in Science, Engineering and Technology

(An ISO 3297: 2007 Certified Organization)

Vol. 4, Special Issue 13, December 2015

5. Introduction to Composite Materials Design, Second Edition (Composite Materials: Design and Analysis) by Ever J. Barbero (Nov 1, 1998).
6. Handbook of Practical Gear Design by Darle W. Dudley.
7. The Art of Gear Fabrication by Prem H Daryani and Harold Josephs