

# Enhanced Bandwidth and Multiband Operation using Asymmetric and Symmetric Double U-Slot Structures on RMSA

Sreelatha K K<sup>1</sup>, Santhosh B.S<sup>2</sup>, Priyanka R.Ravi<sup>3</sup>

Assistant Professor, Department of Electronics and Communication Engineering, College of Engineering and Management, Punnapra, Alappuzha, Kerala, India<sup>1</sup>

Assistant Professor, Department of Electronics Communication Engineering, College of Engineering, Perumon, Kerala, India<sup>2</sup>

PG Student, Department of Electronics, Cochin University of Science and Technology, Ernakulam, Kerala, India<sup>3</sup>

**ABSTRACT:** This paper presents different configurations of double U-slotted RMSAs such as symmetric and asymmetric structures to yield multi band and wideband applications. In this proposed work investigates the bandwidth enhancement of RMSA by U slot techniques using symmetric and asymmetric Us. The proposed antenna geometries describes a coaxial fed rectangular patch printed over a FR4 substrate of thickness 1.6mm and permittivity  $\epsilon_r = 4.4$ . Broadening the antenna bandwidth is achieved by U-slot techniques. The design parameters for the proposed antennas are length, width and position of the U slots. Performance of antennas are analyzed based on the parameter impedance - Bandwidth, using s11 (return loss) plot. The antenna operating frequency range desired in this paper is 1.5GHz – 3.5 GHz. The optimum antenna designs for desired frequency range is obtained using HFSS and band width and return loss of optimum antenna designs are measured through network analyzer. The proposed antennas are suitable for WiMax and LTE (1.6/2.6/3.1 GHz) applications.

**KEYWORDS:** HFSS, FR4 substrate, RMSA, Double U slot.

## I. INTRODUCTION

The demand for broad-band antennas is increased for use in high-frequency and high-speed data communication. Microstrip patch antennas are commonly used in nowadays due to its light weight, less volume, compatibility with integrated circuits, easy to install and low cost. Unfortunately, microstrip patch antenna has a very narrow frequency bandwidth that limits its use in typical communication systems. However, if the frequency bandwidth is to be widened, a broad-band microstrip antenna would prove very useful in commercial applications such as 2.5 G and 3 and 4G wireless systems, wireless local area networks (WLAN), and Bluetooth personal networks. Researchers have devised several methods to increase the bandwidth of microstrip antennas [1],[2],[11].

The bandwidth improvement in microstrip patch antenna using basic U slot geometry was introduced by Huynh and Lee in 1995[6]. However subsequent researchers revealed that wideband characteristics can be modified to multiband characteristics by using intelligent placement of U slots [10].

In this paper, we demonstrate that the U-slot techniques [5], [7], [9] can be used to design patch antennas with triple band and dual band extended bandwidth applications. The asymmetric double U slotted rectangular micro strip antenna is considered for getting triple band operation and symmetric double U slotted RMSA is as candidate for dual band extended band width operation. The basic RMSA is design to support 2.4GHz. The triple band antenna resonates at 1.6GHz, 2.6GHz, 3.1GHz and asymmetric double U slotted antenna supports 1.6GHz, 3.1GHz with enhance band width compared to conventional RMSA.

## II. RELATED WORK

In this paper [4], an asymmetric U-slot patch antenna with low probe diameter is presented. It shows that reduction in probe diameter causes in reduction in bandwidth. The presented antenna in this paper has been fabricated by PCB technique and tested. Its low size and being possible to fabricate using PCB technique, can be used in array applications. This antenna can be recommended when a circular polarisation is used, but in linear polarisation applications, it has high cross polarisation level, which should be noticed in its application.

This paper [7], proposed a double u-slot patch antenna with dual wideband characteristics. In the proposed work the use of a patch antenna with two u-shaped slots to achieve dual band operation. A thick substrate helps broaden the individual bandwidths. The antenna is designed based on extensive ie3d simulation studies. Microstrip patch antenna is widely considered to be suitable for many wireless applications, even though it usually has a narrow bandwidth.

In this paper [3], Experiential and simulation results are presented on the coaxially fed rectangular patch antenna with a U-shaped slot. It is found that The U-slot patch on a foam substrate of about 0.08h thick can be attain 20-30% impedance as well as gain bandwidths without the need of parasitic patches on another layer or on the same layer. The far-field patterns have good co-polar and cross polar characteristics. Also, a U-slot patch antenna with dual-frequency behaviour is presented.

## III DESIGN OF RMSA

The basic RMSA is a strip conductor of dimensions LXW on a dielectric having dielectric constant  $\epsilon_r$  and thickness 'h' and having a ground plane. For RMSA width is comparable to wavelength to enhance radiation from edges. The substrate thickness is much smaller than the wavelength, therefore RMSA is considered to be 2D planar configuration [6].

### Length

The length of the rectangular patch antenna, in its fundamental mode.

$$\text{The length is calculated as } L_{eff} = \frac{c}{2f_r \sqrt{\epsilon_{reff}}} \dots\dots (1)$$

Or

$$L \approx 0.49 \lambda_d = 0.49 \lambda_0 / \sqrt{\epsilon_{reff}}$$

Where,  $\lambda_0$  - Wave length of free space L - Resonant length

$\lambda_d$  - Wavelength of PC board

$\epsilon_{reff}$  - effective dielectric constant

$$\epsilon_{reff} = \frac{\epsilon_r + 1}{2} + \frac{\epsilon_r - 1}{2} \left( 1 + \frac{12h}{W} \right)^{-1} \dots\dots\dots (2)$$

### Width

For RMSA to be an efficient radiator, W should be taken equal to a half wavelength corresponding to the average of the two dielectric mediums (i.e., substrate and air)

$$\text{Width}(W) = \frac{c}{2f_r} + \sqrt{\frac{2}{\epsilon_r + 1}} \dots\dots\dots (3)$$

c = Speed of light

$f_r$  = the resonant frequency which is equal to 2.4GHz

$$\Delta L = 0.412h \frac{[\epsilon_{reff} + 0.3] \left[ \frac{W}{h} + 0.264 \right]}{[\epsilon_{reff} - 0.258] \left[ \frac{W}{h} + 0.8 \right]} \dots\dots\dots (4)$$

$$L = L_{eff} - 2\Delta L$$

From these equations (1-4), a RMSA was designed to operate over frequency of 2.4 GHz. The optimized length and width of the RMSA was found to be 29 mm and 38mm, respectively. This RMSA was simulated using Ansoft HFSS. For simulations, the FR4 substrate with dielectric constant of 4.4 with thickness of 1.6 mm was considered.

#### IV. ANTENNA CONFIGURATION

##### A. RMSA

The antenna is designed using design equations (1-4). Using these values, the antenna structure is simulated and optimized in Ansoft HFSS14.0. The antenna parameters loss tangent, probe diameter, substrate dielectric constant, height of substrate are 0.02, 0.64mm, 4.4 (FR4), 1.6 respectively.

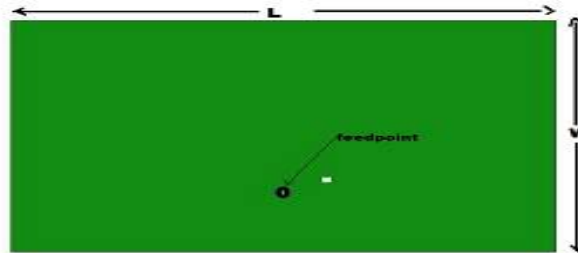

Fig 1: RMSA DESIGN GEOMETRY.

The dimensions of RMSA are shown in Fig 1. The optimized value of  $w$  and  $L$  for minimum value of RL for 2.4GHz is Table I

Table I: optimized value of  $W$  and  $L$   
All dimensions are in mm.

RMSA Parameters	Designed values(mm)
Dielectric substrate(FR4)	4.4
$\Delta L$	0.738mm
$L$	29mm
$W$	38mm
Feedpoint(xf,yf)	(7,0)

##### B. SYMMETRIC U SLOTTED RMSA

This antenna design uses Symmetric U slot structure added on to the RMSA. The entire structure is at the centre of patch and keeps symmetry in its structure. Basic RMSA is designed at 2.4GHz. But adding U slot increases the bandwidth but lowers the resonant frequency [3]. The optimized antenna design parameters are in TABLE II.

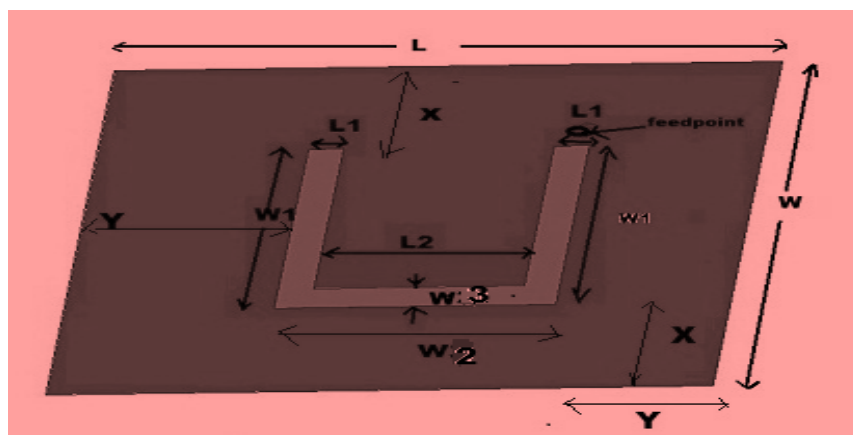

Fig 2: Symmetric U slotted RMSA

TABLE II: Optimized value of U slotted structure.  
All dimensions are in mm.

L	38	X	7.4
W	29	Y	12
L1	2	W2	14
L2	10	Feed point	(8.6,-8.6)
W1	14	W3	1.7

**C. ASYMMETRIC U SLOTTED STRUCTURE.**

From the simulation result of section B, It is found that it is difficult to tune the structure with keeping the symmetry of U slot, so a linearity is allowed in the dimensions .i.e. arms of the U are selected different values .The basic patch is designed for 2.4 GHz and adding U slot to this, results in enhanced BW RMSA as 2.3-2.4GHz.

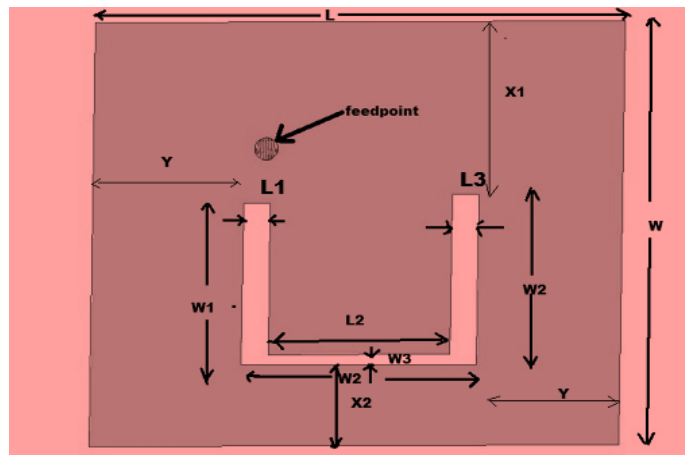

Fig 3: Asymmetric U slotted RMSA

From Fig 2. it is observed that the difference in structure from the previous section is asymmetry in arm lengths and distances X1 and X2. All the components of structure are simulated using HFSS on 1.6mm thick FR4 material which had dielectric constant 4.4. The table III shows the optimized value of U slotted RMSA

Table III :Optimized value of U slotted RMSA  
All dimensions are in mm.

L	28.8	X1	10
W	24.1	X2	4.6
L1	1.45	Y	7.75
L2	10.4	W1	9.2
L3	1.45	W2	9.7
W2'	13.3	W3	.6

**D. DOUBLE U (USING SYMMETRIC U STRUCTURES).**

In this antenna structure triple band operation is possible. The antenna geometry is fed with a coaxial line feed technique. The structure makes use of two symmetric U slots. The two slots are created on patch which is placed on the dielectric substrate of FR4 material with the overall dimensions of 29 mm × 38 mm × 1.6 mm. The proposed antenna geometry's performance is investigated in the frequency range of 1.5 GHz to 3.5 GHz. This geometry exhibits three resonances at 1.6 GHz, 2.6GHz, and 3.1GHz. The bandwidth at lower resonant frequency was obtained broad as compared to the conventional patch antennas (12~13%). Table IV shows the optimized value of double U slotted RMSA .

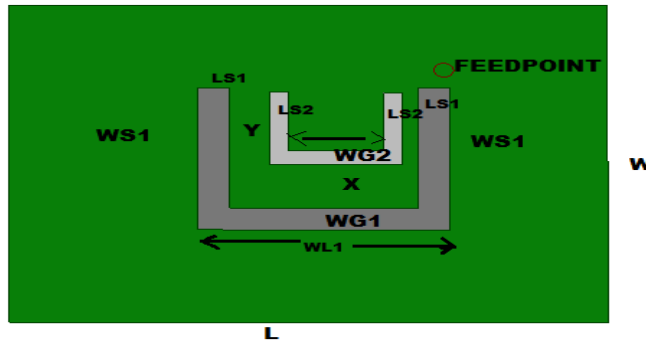

Fig 4: Structure of symmetric double U slotted RMSA.

Table IV optimized value of double U slotted RMSA  
All dimensions are in mm.

L	29	WL1	13
W	38	WG1	2
LS1	2	WG2	1.2
LS2	1.2	X	4
LS3	8.2	Y	2.5
WS1	13	FEEDPOINT	(8.6,-8.6)

#### E. DOUBLE U (USING SYMMETRIC AND ASYMMETRIC STRUCTURES).

Two U slots are created on patch which is placed on the dielectric substrate of FR4 material with the overall dimensions of 29 mm × 38 mm × 1.6 mm. This geometry presented U-Slot antenna which excites dual band operation with improved BW performance. Table V shows the optimized value of double U slotted RMSA .

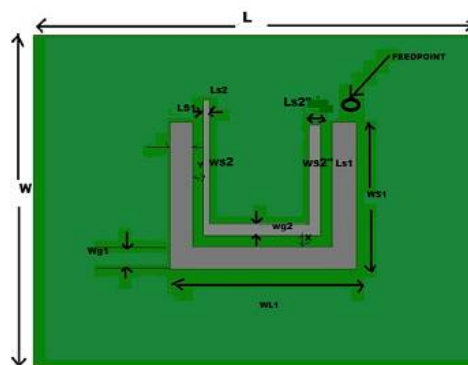

Fig 5 : geometry of asymmetric double U slotted RMSA.

Table V: optimized value of double U slotted RMSA .  
All dimensions are in mm.

L	38	Ws2	9.76
		Ws2''	12
W	29	Wg1	2
Ls1	2	Wg2	1.4
Ls2	.55	X	1.2
Ls2''	1		
LS3	7.5	Y	1.2
Ws1	13	FEEDPOINT	8.6,-8.6

### V. SIMULATED RESULTS.

The simulation results of the various structures in section IV from A to E

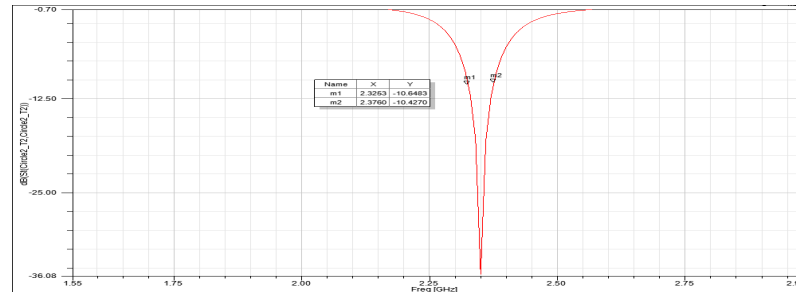

Fig 6 : Simulated S11 simple RMSA at 2.4GHz

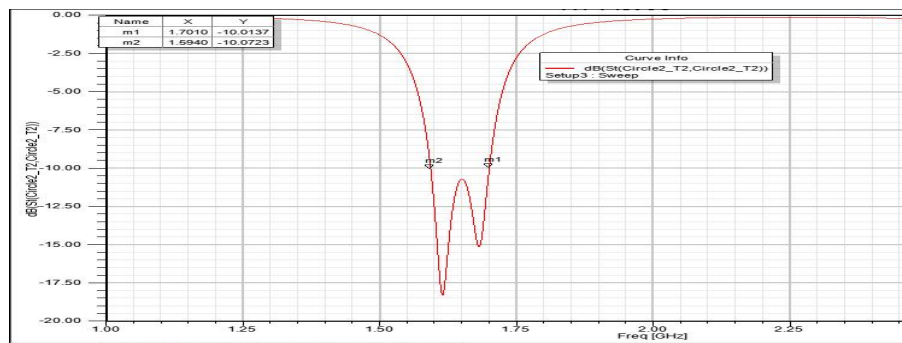

Fig 7 : Simulated symmetric U slotted RMSA- return loss Vs frequency showing extended band width and reduction in resonant frequency.

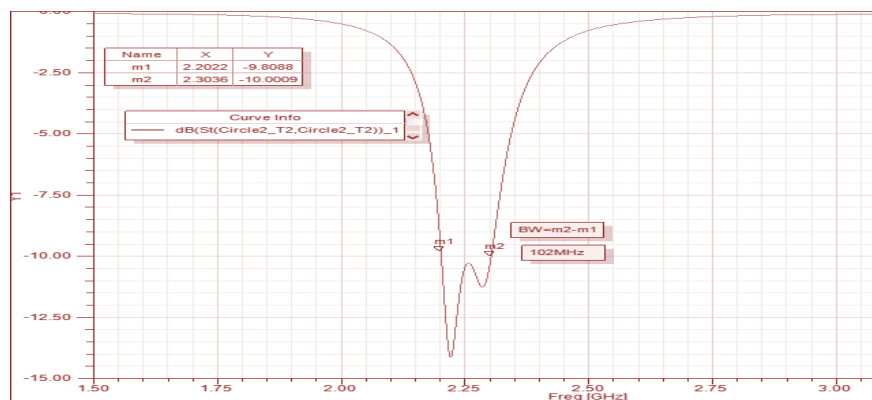

Fig 8: Asymmetric U slotted RMSA - Simulated return loss Vs frequency showing extended band with near 2.4GHz.

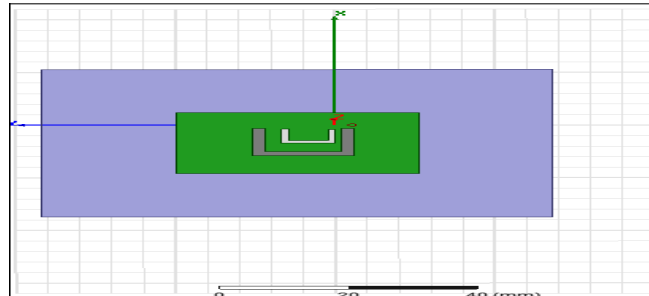

Fig 9: Simulated structure of symmetric double U slotted RMSA.

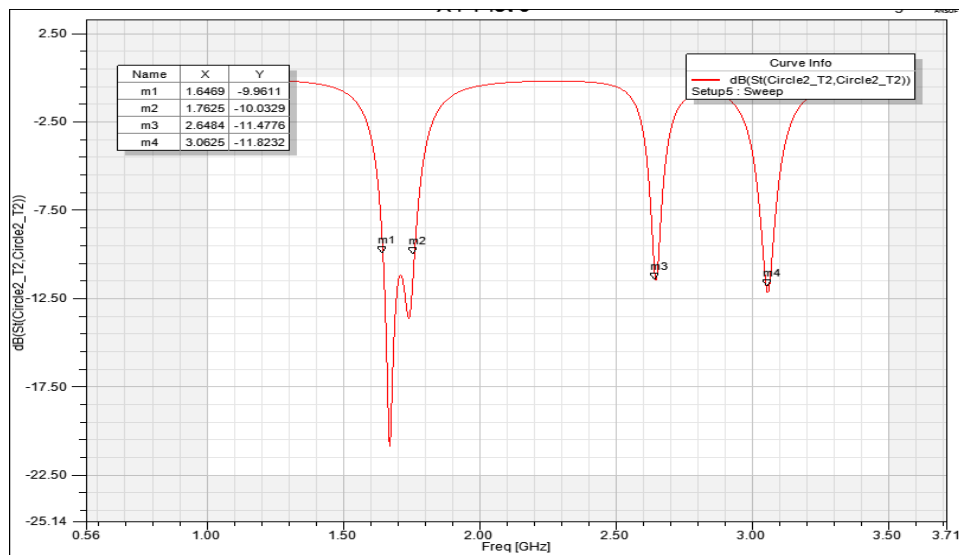

Fig 10: Simulated s11 showing triple band operation.

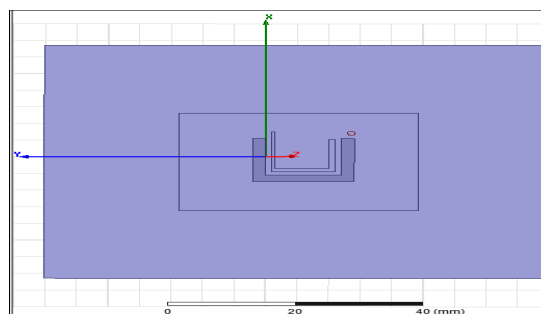

Fig 11 : Simulated structure of asymmetric double U slotted RMSA

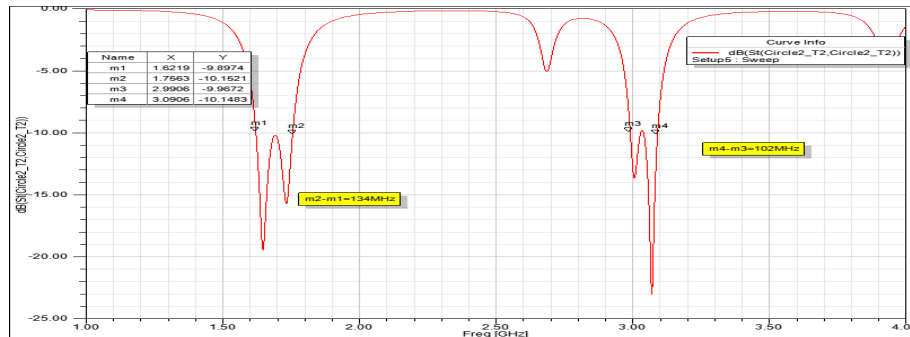

Fig 12: Simulated s11 showing dual band operation with enhanced bandwidth

### VI .FABRICATION OF THE ANTENNA- RESULTS AND DISCUSSIONS

The proposed geometry of antennas in section IV(B ,C,D and E) are fabricated and tested for its validation. Measured results fairly agree with the simulated values.

#### Symmetric U slotted RMSA

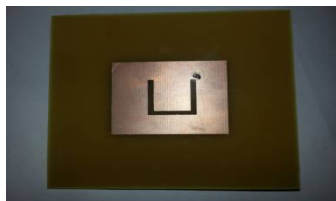

Fig 13: Fabricated u slotted RMSA structure.

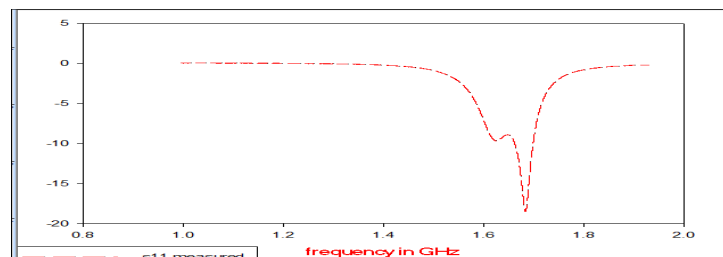

Fig 14: Measured result of Fabricated u slotted RMSA.

#### Symmetric Double U slotted RMSA



Fig 15: The fabricated antenna symmetric double U structure on RMSA.



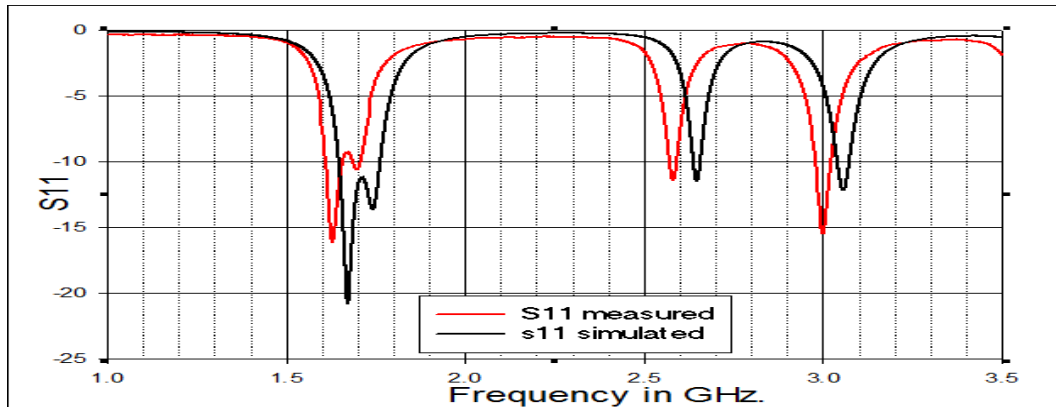

Fig 16: Results of Simulated and measured s11 of fig.15

Three resonances at 1.65 GHz, 2.65 GHz, and 3.1GHz. The bandwidth at lower resonant frequency was obtained broad as compared to the conventional patch antennas (12~13%).Fabricated antenna is tested for its validation. Measured results fairly agree with the simulated values.

#### Asymmetric Double U (combination of symmetric and asymmetric structures)

Based on the simulation results, the two slots are created on patch which is placed on the dielectric substrate of FR4 material with the overall dimensions of 29 mm × 38 mm × 1.6 mm. Two resonances at 1.65 GHz, 2, and 3.1GHz. The bandwidth of both the resonant frequency is obtained broad as compared to the conventional patch antennas (12~13%).Fabricated antenna is tested for its validation. Measured results fairly agree with the simulated values.

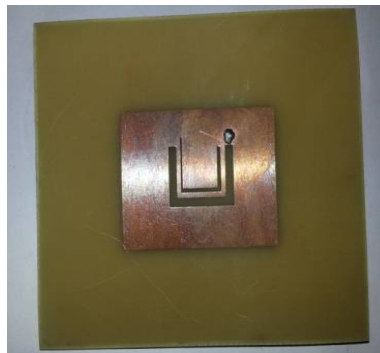

Fig 17: Fabricated antenna structure of asymmetric Double U

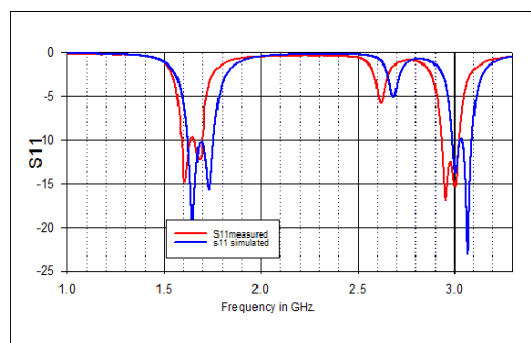

Fig 18: Simulated and measured s11 showing dual band extended band width operation

**SUMMARY OF RESULTS:**

Antenna type	Center Frequency	Return loss	Bandwidth
CONVENTIONAL RMSA	2.4GHz	-36dB	50MHz
SYMMETRIC DOUBLE U SLOTTED RMSA	1.6GHz,2.6GHz,3.1GHz	-22dB,-12dB,-15dB	100MHz,45MHz,50MHz
ASYMMETRIC DOUBLE U SLOTTED RMSA	1.6GHz,3.1GHz	-21 dB,-25dB	180MHz,120MHz

**VII. CONCLUSION**

From the simulation results of RMSA, it is observed that the technique of adding U slots broadens the antenna bandwidth. For the purpose of implementing this technique, an antenna geometry that involves a coaxial fed rectangular patch printed over a FR4 substrate of thickness 1.6mm and permittivity  $\epsilon_r=4.4$  is used. The design parameters for the antennas are optimized using HFSS. The results shows that the BW enhancement and multiband operation are attained using various Double U structures on RMSA. The measured results shows that BW extension and multiband operation at various Center frequencies using asymmetric and symmetric double U slots on conventional RMSA is in good agreement with simulated result.

**REFERENCES**

[1] Norbahiah Misran, Mohammed N. Shakib, Mohammad T. Islam, and Baharudin Yatim “Design Analysis of a Slotted Micro strip Antenna for Wireless Communication”. World Academy of Science, Engineering and Technology volume 37, published in jan 2009.

[2] H. F. AbuTarboush, H. S. Al-Raweshidy and R. Nilavalan “Bandwidth Enhancement for Micro strip Patch Antenna Using Stacked Patch and Slot”. Antenna Technology, 2009. iWAT 2009. IEEE International Workshop on 2-4 March 2009.

[3] D.Sugumar 1, Shalet sydney2, Dhanaraju Athina. “Bandwidth Enhancement of Coaxial Feed U Slotted Micro strip Antenna Modelled with FDTD Algorithm”IEEE international conference on computational intelligence and computing research, 2010.

[4] G. F. Khodaei, j. Nourinia, and c. Ghobadi.“A practical miniaturized u-slot patch antenna with enhanced bandwidth” Progr. Electromagn.Res. B, vol. 3, pp. 47–62, 2008.

[5] K.F. Lee,K.M.Luk,K. F. Tong, S.M.Shum,T.Huynh “Experimental and simulation studies of the coaxially fed U-slot rectangular patch antenna”. Source IEEE Proceedings - Microwaves, Antennas and Propagation, Volume 144, Issue 5, October 1997, p. 354 – 358.

[6]T. Huynh and K. F. Lee, “Single-layer single-patch wideband microstrip antenna,” Electron. Lett, vol. 31, no. 16, pp. 1310–1312, Aug. 1995.

[7] B. Vedaprabhu and K. J. Vinoy, “An integrated wideband multifunctional antenna using a microstrip patch with two U-slots,” Progr. Electromagn.Res. B, vol. 22, pp. 221–235, 2010.

[8] S. G. Weigand, H. Huff, K. H. Pan, and J. T. Bernhard, “Analysis and design of broadband single layer rectangular U-slot microstrip patch antenna,” IEEE Trans. Antennas Propag., 51, no. 3, pp. 457–468,Mar. 2003.

[9] P. Vetrivelvi, Sathiyamoorthy Murugan., Dr.V.Rajamani. “Design of Wideband U Slot Microstrip Antenna”. International Journal of Innovative Research in Science, Engineering and Technology Volume 3 Special Issue 3 March2014.

[10] Tej Raj, Brajlata Chauhan. “Single Layer Dual band Microstrip Patch Antenna using Probe Feed” International journal of Computer Applications (0975 –8887) Volume 92 –No.12 April 2014.

[11] Y.L.Chow, Z.N. Chen', K.F. Lee and K.M. Luk “A Design Theory on Broadband Patch Antennas with Slot” IEEE Trans Antennas and Propagation.