

# Design and Analysis of Hybrid PV and Wind System with Power Quality Improvement

Sushmasumathi B<sup>1</sup>, Dr M S Shashikala<sup>2</sup>

M.Tech Student, Department of EEE, JSS Science and Technology, Mysuru, India<sup>1</sup>

Professor, Department of EEE, JSS Science and Technology, Mysuru, India<sup>2</sup>

**ABSTRACT:** In recent decades, conventional electric grid is unable to meet the demands of the world regarding reliable, efficient and supply the clean energy. Hence, a new method of electrical grid is necessary to overcome the problems faced by conventional grid. In this project, Hybrid energy system which includes both PV and Wind system as an alternative source for conventional source of electrical energy like thermal and hydro power generation is presented. MPPT technique which is cost effective is used to track the maximum power point from the PV system and Wind generator system, MI cuk DC-DC converter is used to integrate the PV and Wind system. The project aims in the design and analyse the operation of Hybrid system with power quality enhancement features. In order to improve the power quality and stability of the Hybrid energy system, a hysteresis based current controller with bi directional power flow method is employed. The power harmonic filters are used in the inverter side to reduce the harmonics of the output voltage. The project aims to, regulate the output voltage of three phase inverter, compensate the wind and solar irradiance changes and Bi directional power flow mechanism. The wind and PV Hybrid system model is developed using the MATLAB/Simlink system toolbox. The proposed Hybrid system for two different mode of operations i.e as Grid connected and Standalone system are simulated in MATLAB/Simulink with and without a filter circuit. The output voltage waveforms and the total harmonic distortion (THD) using FFT analysis tool is observed.

**KEYWORDS:** Microgrid, Hybrid system, DC-DC converters, inverter, power harmonic filter, power quality, THD, Hysteresis based Bidirectional power flow system, Standalone system.

## I. INTRODUCTION

Due to the fast depletion of fossil fuel reserves, to meet energy demand and environmental concerns there is a need for alternate sources of energy to fulfil the present energy demand. The critical condition of industrial fuels which include oil, gas and others, the development of renewable energy sources is continuously improving [1]. This is the reason why renewable energy sources have become more important these days. Few other reasons include advantages like abundant availability in nature, eco-friendly and recyclable. Out of all the renewable energy resources solar and wind energy are the world's fastest growing energy resources and clean, vast and reliable energy sources to meet up the present power scenario in the world especially in India. So this project aims in designing the Hybrid PV and Wind system which acts as Microgrid to supply power for local loads and it can be worked as Grid connected system. The Microgrid concept, involving small transmission and distribution (T&D) networks, efficiently makes use of all the location specific distributed generation and distributed energy resources. These are self sustained power systems mainly based on loads fed through radial distribution systems and can operate either interconnected to the main distribution grid, or even in isolated mode [2]. The practical implementation of a Microgrid admits wide variety of exercises that include economic analysis, grid connected issues, stability and protection issues, power control strategies and various control techniques of power sharing in microgrid, which includes concentrated control, master/slave control, distributed control which perform a good power current sharing in only linear loads but it has low reliability and redundancy [3][4].

Hybrid power systems consist of a combination of renewable energy sources such as: photovoltaic (PV), wind generators, hydro, etc., to charge batteries and provide power to meet the energy demand, considering the local geography and other details of the place of installation. These types of systems, which are not connected to the main

# International Journal of Innovative Research in Science, Engineering and Technology

(A High Impact Factor, Monthly, Peer Reviewed Journal)

Visit: [www.ijirset.com](http://www.ijirset.com)

Vol. 7, Issue 8, August 2018

utility grid, are also used in stand-alone applications and operate independently and reliably. The best applications for these systems are in remote places, such as rural villages, in communications, etc. The importance of hybrid systems has grown as they appeared to be the right solution for a clean and distributed energy production. It has to be mentioned that new implementations of hybrid systems require special attention on analysis and modeling. A major importance for the theoretical study of hybrid systems, based on renewable energy (photovoltaic, wind systems), is the availability of models, which can be used to study the behaviour of hybrid systems, and most important, software simulation [5]. There are several types of maximum power point tracking methods in use for Wind and Solar PV applications. Some of them are useful in sudden change in wind speeds as well as insolation levels for PV and some are efficient in steady variation in wind speeds as well as insolation levels. The main approach of the proposed work is to hybridize two sources together. The results are taken with variation in wind speed and with PV insolation levels. Researchers have proposed MPPT algorithm with their comparative merits and demerits [6]. The main objective of such algorithm is to achieve faster and accurate tracking performance as well as reduction in oscillations around maximum power points. Standalone approach of Hybrid system is discussed, they have compared variable speed generators with maximum power extraction capability for large rating of permanent magnet synchronous generators and doubly fed induction generators [7-9]. With the development of the power electronics devices and different control strategy, the Hybrid systems could be controlled by using power electronics to enhance the system performance at the point of mutual coupling. But, the broad usage of power electronics based equipment's and controllers at the point of mutual coupling creates harmonic currents, then it would weaken the power quality. Frequently, current controlled and voltage controlled inverters are employed to interconnection the renewable energy sources in distributed level. To hold the harmonic current, the inverter can run as an active inductor at the certain level of frequency. An active shunt filter will act as active conductance to clear out the harmonics contains in distribution network. Thus this could enhance the system response speed and reliability, the hybrid system model which includes PV and Wind system is discussed and synchronous type wind generator is used with the variable speed control technique are used to extract the maximum wind power throughout the day. In order to enhance the capacity to improve the power quality and stability of microgrid hybrid energy system, a hysteresis based bi-directional Power Transfer strategy with power harmonic filter is presented. Advantages of using hysteresis band control are excellent dynamic performance and ability to control the peak to peak value of current ripple in desired hysteresis band limit. It is also very simple for physically implementation [10][11].

## II. PROCEDURE OF PROPOSED HYBRID SYSTEM

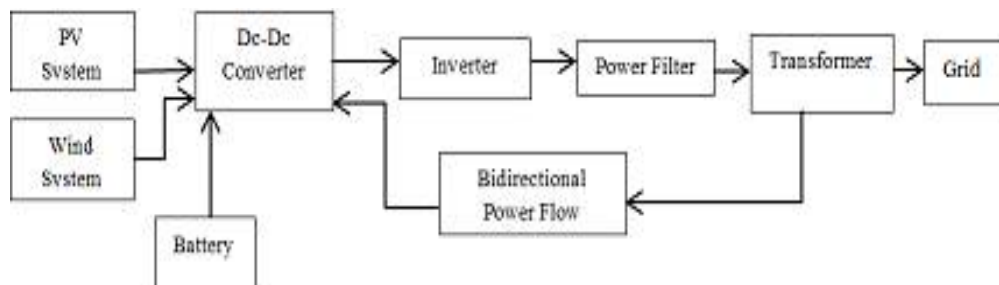

Fig 1. Overall architecture of the Proposed Hybrid System

A Hybrid Microgrid is a small-scale power grid that can operate independently or collaboratively with other small power grids. Any small-scale, localized power station that has its own generation and storage resources and definable boundaries can be considered a microgrid. The modeling of proposed Hybrid Microgrid Energy system by using components like Wind system, PV system, MI Cuk converter, energy storage system like Battery, power harmonic filter using MATLAB. A PV model of 100 kW capacity has to be developed using MATLAB. The

# International Journal of Innovative Research in Science, Engineering and Technology

(A High Impact Factor, Monthly, Peer Reviewed Journal)

Visit: [www.ijirset.com](http://www.ijirset.com)

Vol. 7, Issue 8, August 2018

temperature of the surface of PV panel is considered to be fixed throughout the process of the simulation. The functioning of PV modules are tracked at different points of power to achieve the Maximum power. A Wind system of 15 kW capacity has to be developed using MATLAB. A Wind model is used to simulate the different effect of changing wind components. When the rotor speed of wind turbine goes faster, then wind turbine output power should be increasing. Similarly when the wind turbine rotor speed slows down, then wind turbine output power should be decreasing. The Wind energy changes continually because of wind speed as it changes throughout the day. The amount of power output is tracked by the MPPT controller of the wind energy system. Fig. 1 shows the block representation of the proposed microgrid hybrid energy system with solar, wind and storage system. The Multi input Cuk converter is used, which comprises of many input sources and a single output to combine both PV and wind system and power harmonic filter to reduce the harmonic content of the system using MATLAB Simulink. Implementing a Hysteresis based Bidirectional power flow control in this system which includes two modes i.e. inverter side power flow mode and DC/ DC converter side power flow mode. The inverter side power flow mode is defined as the process of extracting energy from the DC Micro grid and using it to enhancement the grid. This is accomplished by using DC/DC converter voltage to the necessary level after that changing it to ac with the proper frequency and voltage needed to inject current into the grid. The DC/DC converter mode has utilized the grid to give power back to DC micro grid for local DC loads. A hysteresis control method is used for this system because of its comfort of execution[1]. And to analyses, the hysteresis based Bidirectional power flow system, there is the comparison between output current and reference band. Hence, the grid side voltage and output current would be in the phase. Therefore power can flow in both the direction by using this scheme so this is an easy method to control the power of hybrid energy system.

## III. MODELING OF PROPOSED SYSTEM

### 1. PV System Model:

The PV array block implements an array of photovoltaic (PV) modules. The array is built of strings of modules connected in parallel, each string consisting of modules connected in series. A 100-kW PV array is operated both as standalone and connected to a grid via a MI cuk converter and a three-phase three-level Voltage Source Converter (VSC). Maximum Power Point Tracking (MPPT) is implemented in the system by means of a Simulink model using the 'Perturb & Observe' technique. The 100 kW PV array consists of 66 strings of 5 series-connected 305.2 W modules connected in parallel ( $66 \times 5 \times 305.2 \text{ W} = 100.7 \text{ kW}$ ). Number of series-connected cells : 96  
The values of single PV module is given ,Open-circuit voltage:  $V_{oc} = 64.2 \text{ V}$ , Short-circuit current:  $I_{sc} = 5.96 \text{ A}$ , Voltage and current at maximum power :  $V_{mp} = 54.7 \text{ V}$ ,  $I_{mp} = 5.58 \text{ A}$ . The PV array block shown in Fig 2 has two inputs that allow you varying sun irradiance (input 1 in  $\text{W}/\text{m}^2$ ) and temperature (input 2 in  $^{\circ}\text{C}$ ). The PV array is operated at  $25^{\circ}\text{C}$  temperature,  $1000 \text{ w}/\text{m}^2$  irradiance.

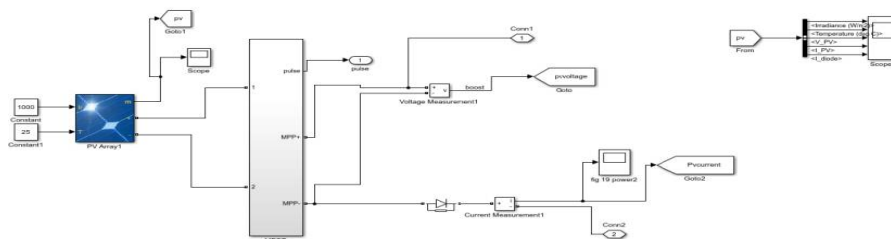

Fig 2: Block diagram of PV system in Simulink

### 2. Wind System Model:

A wind turbine converts kinetic energy of air i.e. wind power into mechanical power i.e. rotating motion of the turbine that can be used directly to run the machine or generator. Power captured by wind turbine blade is a concomitant of the blade shape, the pitch angle, speed of rotation, radius of the rotor. The model is based on the steady-

# International Journal of Innovative Research in Science, Engineering and Technology

(A High Impact Factor, Monthly, Peer Reviewed Journal)

Visit: [www.ijirset.com](http://www.ijirset.com)

Vol. 7, Issue 8, August 2018

state power characteristics of the turbine. The stiffness of the drive train is infinite and the friction factor and the inertia of the turbine must be combined with those of the generator coupled to the turbine. The performance coefficient  $C_p$  of the turbine is the mechanical output power of the turbine divided by wind power and a function of wind speed, rotational speed, and pitch angle ( $\beta$ ).  $C_p$  reaches its maximum value at zero  $\beta$ .

The first input is the generator speed in per unit of the generator base speed. For a synchronous or asynchronous generator, the base speed is the synchronous speed. For a permanent-magnet generator, the base speed is defined as the speed producing nominal voltage at no load. The second input is the blade pitch angle ( $\beta$ ) in degrees. The third input is the wind speed in m/s.

The output of the generator is given to Rectifier as the power generated by the wind system is AC, so it has to be converted from AC to DC when it is integrated with PV system. The rotor speed is regulated and given to pitch angle controller to generate desired pitch angle that is given to the wind turbine. The Block representation of Proposed Wind System using Permanent Magnet Synchronous generator with base wind speed as 12 m/s is shown in the fig 3.

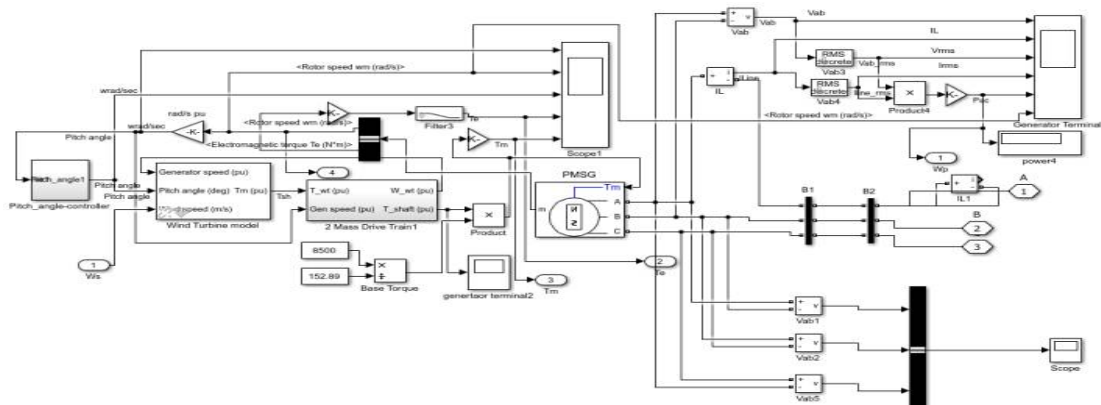

Fig 3: Block representation of Wind system in Simulink

### 3. Battery System Model:

A storage system like battery is used as an alternate source of power if renewable energy sources power generation is insufficient to satisfy the load demand and to improve the stability as well as the efficiency of the microgrid. This battery system gives power to the load similarly if power generation is higher than the load demand then the battery system stores energy. The Battery block used implements a generic dynamic model parameterized to represent most popular types of rechargeable batteries. The Block representation of Battery System in Simulink is shown in the fig 4.

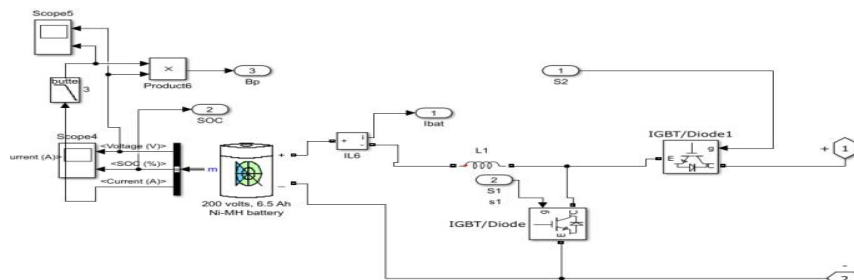

Fig 4: Block representation of Battery System in Simulink

The Battery system consists of a bidirectional DC-DC converter, the two IGBTs in the block act as a DC-DC converter when  $S_1$  is high (1), the IGBT which is connected to the negative terminal of the battery will operate and when  $S_2$  is high (1), the IGBT which is connected to the positive terminal of the battery will operate. The output of the battery can be connected to a scope to obtain the voltage, current, and state of charge values.

# International Journal of Innovative Research in Science, Engineering and Technology

(A High Impact Factor, Monthly, Peer Reviewed Journal)

Visit: [www.ijirset.com](http://www.ijirset.com)

Vol. 7, Issue 8, August 2018

#### 4. MI Cuk converter:

The converter consists of multi input and single output which converts variable DC to fixed DC. The output from wind system is given to input 1 of the converter and the output from the PV system is given to input 2 of the converter. The converter integrates both these energy by using inductor, MOSFET, and diode circuit. The output of converter is given to the inverter which converts the fixed DC to AC. The value of inductor is taken as  $2 \times 10^{-3}$  H. MOSFET and internal diode in parallel with a series RC snubber circuit. When a gate signal is applied the MOSFET conducts and acts as a resistance in both directions. If the gate signal falls to zero when current is negative, current is transferred to the antiparallel diode. The block representation of the converter is shown in the fig 5.

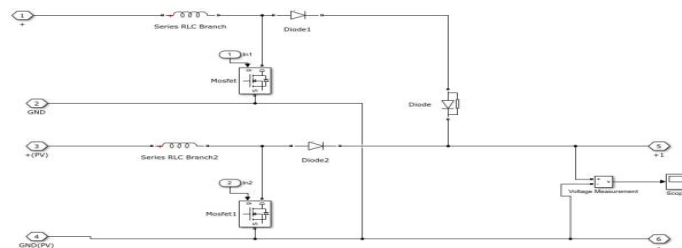

Fig 5: Block representation of the MI Cuk converter

#### 5. Power Harmonic Filter:

Power harmonic filter consists of RLC elements. This power harmonic filter can reduce the harmonic from the system and also improve the stability of the scheme. The inductor is connected in series and the value of inductor taken is 0.01 H and the capacitor is connected in parallel and the value of capacitor taken is 0.001 F. The filter inductor is calculated, assuming voltage drop across it is less than 2% of the nominal voltage.

Thus,

$$L_f = \frac{V_{out(rms)} \times 0.02}{2 \times \pi \times f_o \times I_o}$$

where,

$V_{out(rms)}$  = RMS value of the output voltage,  $I_o$  = the value of output current,  $f_o$  = frequency in Hz.

The filter capacitor is decided according to the cut-off frequency of the low-pass filter. Capacitor is calculated as

$$C_f = \frac{1}{4 \times \pi^2 \times f_c^2 \times L_f}$$

where,

$f_c$  is the cut-off frequency of the filter. For  $f_c = 400$  Hz, capacitor  $C_f$  is calculated.

#### 6. Hysteresis Current Control Technique used in Bi directional Power flow Mechanism:

Bi directional power flow in a proposed Hybrid system is power flow in two opposite directions. The Bi directional power flow in the system operates in two modes: This two modes includes i.e. inverter side power flow mode and DC/ DC converter side power flow mode using hysteresis current control method. This control technique defines upper hysteresis band limit and lower hysteresis band limit. In close loop control, output current signal is compared with reference current signal, which decrease the error in output and gives desired output. The generated gate pulses is controlled by PI or PID controllers. These signals are to power the switching devices, when upper and lower limits of hysteresis bands are exceeded. It is nonlinear method and it is based on current error. This method consists of a comparison between the load current and band limit given to it. When it crosses the upper band limit, the switches turns off, when current crosses the lower band limit, switches turns on. The proposed technique is with fixed hysteresis band for closed loop for obtaining the current ripple at output side, a value of hysteresis band must be as small as possible. It will cause very high switching frequency as well as high switching losses. It also required high-end controllers for better performance in practical[11].



# International Journal of Innovative Research in Science, Engineering and Technology

(A High Impact Factor, Monthly, Peer Reviewed Journal)

Visit: [www.ijirset.com](http://www.ijirset.com)

Vol. 7, Issue 8, August 2018

## IV. SIMULATION MODEL OF PROPOSED HYBRID SYSTEM

In the proposed Hybrid system it is aimed to generate 100 kW capacity power from PV system and 15 kW capacity power from Wind system both together form Microgrid which is operated as both standalone and powered to local loads and interconnected to grid system as well. A dc- dc power converter is needed for this system to improve the reliability of the system and lower the battery voltage to avoid higher voltage fluctuations. MI Cuk DC- DC converter which has multi input and single output operation is used to integrated PV and wind in microgrid. A storage system like battery is used to improve the stability as well as the efficiency of the microgrid. If power generation from renewable energy sources is insufficient to satisfy the load demand, then this battery system gives power to the load. Similarly, if power generation is higher than the load demand then battery system stores energy.

A DC/AC inverter is used to convert DC to AC as most of household appliances run on AC and even to connect to the grid system. To hold the harmonic current, the inverter can run as an active inductor at the certain level of frequency. An active shunt filter will act as active conductance to clear out the harmonics contains in distribution network. Harmonic power filter connecting inverter and AC microgrid can be used to offer the capability to enhance the power quality of the entire system. As soon as a fault or any disturbance on AC micro grid is detected, the power harmonic filter can provide harmonics compensation. Hence, the power harmonic filter becomes an essential component for the microgrid applications. This system is equipped with a bi-directional power flow controller and is connected to the microgrid. This different power flow controller can improve the microgrid performance and power flow within the system. A hysteresis based current control method is used for this system.

### 1. Simulation Model of the proposed Hybrid system as Standalone:

In fig 6, A 100 kW capacity of PV system is combined with 15 kW capacity of Wind system to form Hybrid system. Both energy sources are integrated using MI cuk DC-DC converter, which acts as multi input and single output converter and converts variable DC to fixed DC. The inverter is connected to converter side so that fixed DC can be converted to the AC which is connected to the local loads. In order to reduce the harmonic content in the system, power harmonic filter is connected on the inverter side of the system which consists L-C filter and helps in improving the power quality by reducing the harmonic content in the output voltage. A hysteresis based Bidirectional power flow method is employed in the proposed system, if excess power is generated and supplied it can be allowed to flow back to the system by using Bi directional flow method. Battery is used as a storage device which is stores the excess power generated and uses it to supply the load in addition to the generators when power is required. The resistive load is connected in the proposed system and operated under Standalone condition.

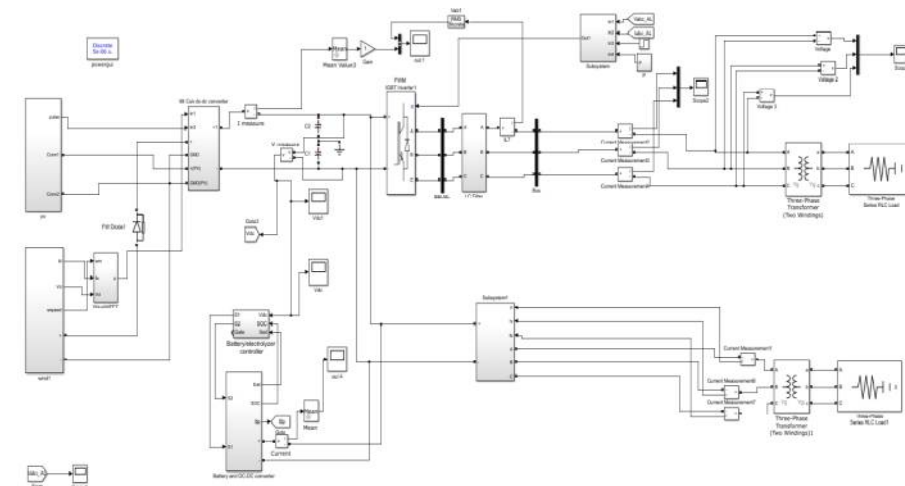

Fig 6:Block diagram representation of Standalone Hybrid system with Bidirectional power flow

# International Journal of Innovative Research in Science, Engineering and Technology

(A High Impact Factor, Monthly, Peer Reviewed Journal)

Visit: [www.ijirset.com](http://www.ijirset.com)

Vol. 7, Issue 8, August 2018

## 2. Simulation Model of proposed Hybrid system as Grid connected:

In the fig 7, A 100 kW capacity of PV system is combined with 15 kW capacity of Wind system to form Hybrid system. Both energy sources are integrated using MI cuk DC-DC converter, which acts as multi input and single output converter and converts variable DC to fixed DC. The inverter is used in the system which converts fixed DC to AC that is connected to the grid by using three phase transformer. In order to reduce the harmonic content in the system, power harmonic filter is connected on the inverter side of the system which consists L-C filter and helps in improving the power quality by reducing the harmonic content in the output voltage. A hysteresis based Bidirectional power flow method is employed in the proposed system, if excess power is generated and supplied to grid, it is allowed to flow back to the system by using Bi directional flow method and stored in Battery. Battery is used as a storage device which is stores the excess power generated and uses it to supply the load in addition to the generators when power is required.

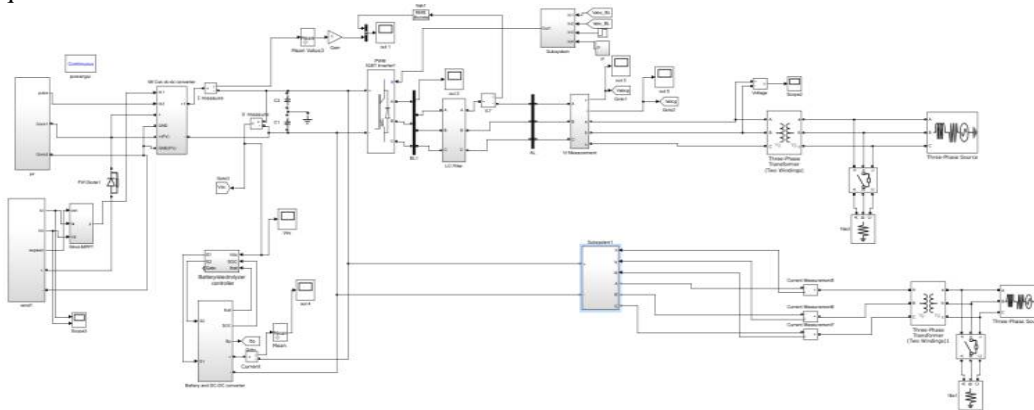

Fig 7: Block diagram representation of Grid connected Hybrid system with Bidirectional power flow

## V. SIMULATION RESULTS

The simulation model of Hybrid PV and Wind system is developed in MATLAB Simulink/Sim Power system. The PV system is aimed to give 100 kW and Wind system is aimed to give 15 kW to feed the Microgrid. In order to enhance the capacity to improve the power quality and stability of hybrid energy system, a hysteresis based bi-directional Power Transfer strategy with power harmonic filter is used. By using FFT analysis tool, the THD of the system with and without filter is measured from the output voltage of the proposed system and they are compared with each other.

### 1. Performance of the PV system with MPPT :

The PV system is aimed to generate 100 kW capacity power, the PV array is operated at 25°C and 1000 w/m<sup>2</sup> irradiance. The 100 kW PV array consists of 66 strings of 5 series-connected 305.2 W modules connected in parallel (66\*5\*305.2 W= 100.7 kW).

- Inputs given to the PV array

Ir - Connect to this input a Simulink signal representing varying sun irradiance in W/m<sup>2</sup>.

T - Connect to this input a Simulink signal representing varying cell temperature in degrees C.

- Outputs obtained from the PV array

m – The Simulink output vector contains five signals. These signals can be selected by using the Bus Selector block in the Simulink library. Fig 8 and Fig 9 shows the I-V characteristics, P-V characteristics of the photovoltaic module respectively and Fig 10 shows the output voltage of PV system.

# International Journal of Innovative Research in Science, Engineering and Technology

(A High Impact Factor, Monthly, Peer Reviewed Journal)

Visit: [www.ijirset.com](http://www.ijirset.com)

Vol. 7, Issue 8, August 2018

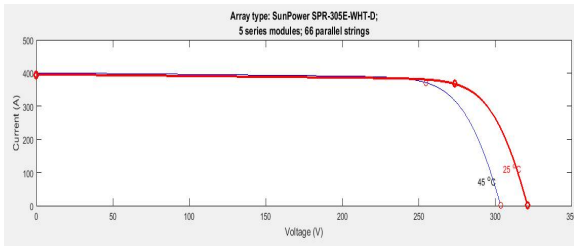

Fig 8 : I-V characteristics curve of the PV system

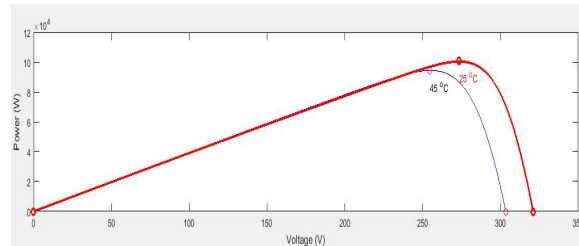

Fig 9: P-V characteristics curve of the PV system

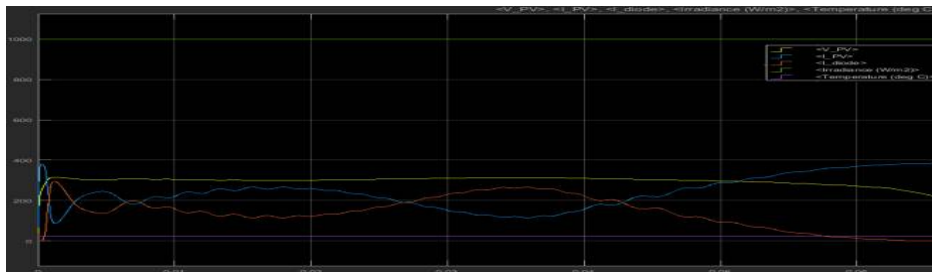

Fig 10: Output of the PV system

## 2. Performance of Wind system with MPPT :

The Wind system is aimed to generate 15 kW capacity power, by considering the base wind speed as 12 m/s and the generator base speed as 1 per unit. The type of the rotor used in generator is round type generator and the number of phase is 3. The output waveform of the proposed Wind system using Simulink software is shown in the fig 11, the waveform of Phase voltage ( $V_{ab}$ ), Line current ( $I_{line}$ ), RMS value of phase voltage ( $V_{ab\_rms}$ ), RMS value of Line current ( $I_{line\_rms}$ ), output Power( $P_{ac}$ ), and the rotor speed is shown which is obtained from the proposed wind system.

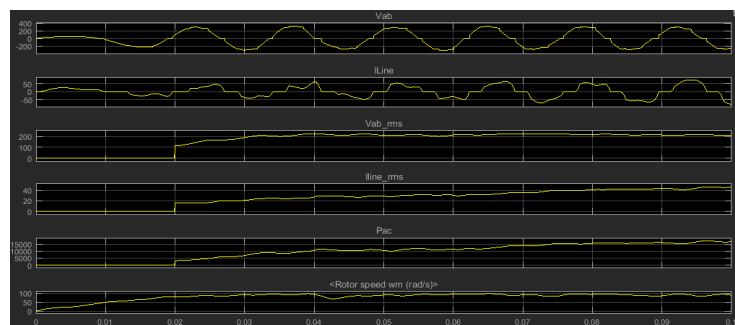

Fig 11: Output waveform of the Wind system

## 3. Simulation result of Hybrid System with Bidirectional power flow operated as Grid connected:

The output voltage of the proposed Hybrid system with Bidirectional power flow integrated with grid obtained is shown in the Fig 12. The three phase AC voltage obtained as inverter output voltage with power harmonic filter.



# International Journal of Innovative Research in Science, Engineering and Technology

(A High Impact Factor, Monthly, Peer Reviewed Journal)

Visit: [www.ijirset.com](http://www.ijirset.com)

Vol. 7, Issue 8, August 2018

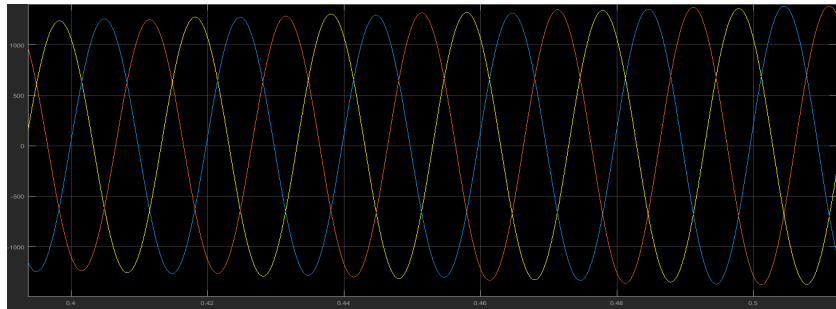

Fig 12: Output waveform of proposed system operated as Grid connected

FFT analysis result with and without filter:

The results are analyzed using FFT analysis tool. In Fig 13, FFT analysis is carried out without power harmonic filter in the proposed Hybrid system as the result, the value of THD obtained is 44.34%. So in order to improve the power quality to reduce the harmonics in the output voltage, the power harmonic filter is connected to the inverter side of the system. In Fig 14, FFT analysis is carried out with power harmonics filter in the proposed Hybrid system as the result, the THD in the system is reduced to 5.70%. Hence it is seen that better power quality is obtained by proposed hybrid system.

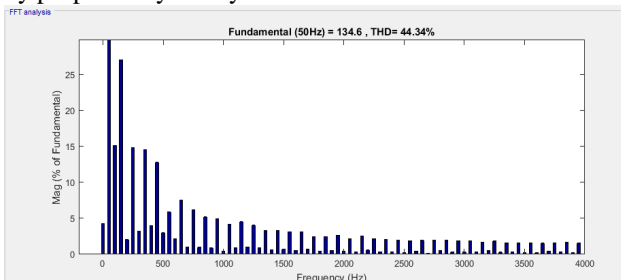

Fig 13: FFT analysis without filter

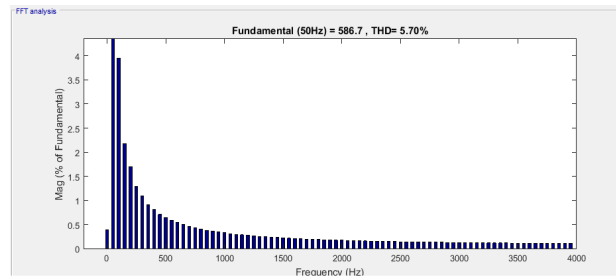

Fig 14: FFT analysis with filter

#### 4. Simulation result of Hybrid system with Bidirectional power flow operated as Standalone system:

The output voltage of the proposed Hybrid PV and Wind system with Bidirectional power flow when operated as Standalone system is shown in the Fig 15



Fig 15: Output waveform of proposed system operated as Standalone

FFT analysis result without and with filter:

The results are analyzed using FFT analysis tool. In Fig 16, FFT analysis is carried out without power harmonic filter in the proposed Hybrid system as the result the value of THD obtained is 715.44%. So in order to improve the power quality by reducing the harmonics in the output voltage, the power harmonic filter is connected to the inverter side of the system. In Fig 17, FFT analysis is carried out with power harmonics filter in the proposed Hybrid system as the

# International Journal of Innovative Research in Science, Engineering and Technology

(A High Impact Factor, Monthly, Peer Reviewed Journal)

Visit: [www.ijirset.com](http://www.ijirset.com)

Vol. 7, Issue 8, August 2018

result the THD in the system is reduced to 29.14%. Hence it is seen that better power quality is obtained by proposed hybrid system.

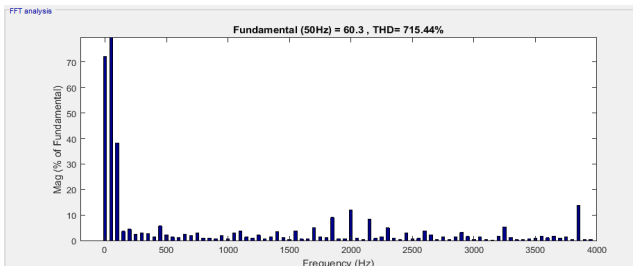

Fig 16: FFT analysis without filter

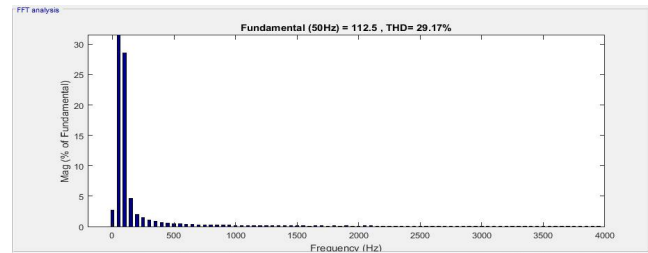

Fig 17: FFT analysis with filter

The summary of the simulation results of the proposed Hybrid system obtained under two different mode of operation are tabulated in Table 1 and Table 2.

**Table 1: Simulation Result of proposed system operated as Grid connected**

Result of Proposed Hybrid System with Bidirectional power flow operated as Grid connected	
Without Power Harmonic Filter	44.34% THD
With Power Harmonic Filter	5.70% THD

**Table 2: Simulation Result of proposed system operated as Standalone system**

Result of Proposed Hybrid System with Bidirectional power flow operated as Standalone	
Without Power Harmonic Filter	715.44% THD
With Power Harmonic Filter	29.17% THD

## VI. CONCLUSION

This project has proposed Hybrid PV and Wind system with Bidirectional power flow mechanism operated as Grid connected as well as Standalone system. A Hybrid energy system is designed and developed in MATLAB Simulink/Simpower software tool. The PV and Wind system are combined together to form the Hybrid energy system which is connected to the loads. A MI cuk DC-DC converter is used to integrate the solar and wind energy sources to the hybrid system. The power harmonic filter is designed on the inverter side of the system. By using, hysteresis based bi-directional Power flow strategy with power harmonic filter, reduction in the THD in output voltage of the system is observed using FFT analysis tool. Hence, power quality improvement is achieved by implementing the proposed system as it hold good for both standalone and grid connected mode of operation. For the designed values and specifications, simulation implementation is carried out using MATLAB/Simulink. Simulation results/waveforms are analyzed and performances are tabulated. The total harmonic distortion of the proposed Hybrid system without filter is found to be 44.34% and with filter is found to be 5.70% when it is operated as Grid connected. The total harmonic distortion of the proposed Hybrid system without filter is found to be 715.44% and with filter is found to be 29.17% when it is operated as Standalone system. The THDs of the proposed Hybrid system with Bidirectional power flow using hysteresis current control mechanism when operated as grid connected and standalone system are obtained as 5.70% and 29.17% respectively.

## International Journal of Innovative Research in Science, Engineering and Technology

(A High Impact Factor, Monthly, Peer Reviewed Journal)

Visit: [www.ijirset.com](http://www.ijirset.com)

Vol. 7, Issue 8, August 2018

### REFERENCES

- [1] SheerazKirmani et al., "Bi-directional Power Control Mechanism for a Microgrid Hybrid Energy System with Power Quality Enhancement Capabilities" - INTERNATIONAL JOURNAL of RENEWABLE ENERGY RESEARCH , Vol.7, No.4, 2017.
- [2] V. S. K. Murthy Balijepalli et al., "Deployment of Micro Grids in India" -978-1-4244-6551-4/10/ 2010 IEEE.
- [3] SnehalVaidya et al., "Review of Various Control Techniques for Power Sharing in Micro Grid" - 2016 International Conference on Global Trends in Signal Processing, Information Computing and Communication.
- [4] Sibtainul Hassan et al., "Advanced Control Techniques for Micro-grids Power Quality Improvement" - 978-1-5386-0971-2/17/ 2017 IEEE.
- [5] JitendraKasera et al., "Modeling and Simulation of Wind-PV Hybrid Power System using MATLAB/Simulink" - 2012 IEEE Students' Conference on Electrical, Electronics and Computer Science.
- [6] Xiaofeng Sun et al., "A Hybrid Renewable DC Microgrid Voltage Control" - 978-1-4244-3557-9/09/ 2009 IEEE.
- [7] Shun Yang et al., "Modeling and Control of the PMSG Wind Generation System With A Novel Controller"- 2013 Third International Conference on Intelligent System Design and Engineering Applications.
- [8] Siddharth Joshi et al., "Hybrid Wind Photovoltaic Standalone System" -978-1-5090-0128-6/16/ 2016 IEEE.
- [9] . N. Bhende et al., "Permanent Magnet Synchronous Generator-Based Standalone Wind Energy Supply System" -IEEE TRANSACTIONS ON SUSTAINABLE ENERGY, VOL. 2, NO. 4, OCTOBER 2011.
- [10] Z. Benhachani et al., "Optimal sizing of a Solar-Wind Hybrid System Supplying a farm in a semi-arid region of Algeria".
- [11] Nelson A. Patel et al., "A Hysteresis Current Control Technique for Electronics Converter" - International Journal of Innovative Research in Science, Engineering and Technology Vol. 5, Issue 2, February 2016.
- [12] NasrudinAbd Rahim et al., "Hysteresis Current Control and Sensorless MPPT for Grid-Connected Photovoltaic Systems"- 1-4244-0755-9/07 - 2007 IEEE