

# Effect of Injection Pressure on the Performance and Emission Characteristics of Diesel Engine Fuelled With Various Blends of Thevetia Peruviana Biodiesel

A.J. Deokar<sup>1</sup>, Dr. G.R. Selokar<sup>2</sup>Research Student, Sri Satya Sai University of Technology and Medical Sciences, Sehore, Madhya Pradesh, India <sup>1</sup>Research Guide, Sri Satya Sai University of Technology and Medical Sciences, Sehore, Madhya Pradesh, India<sup>2</sup>

**ABSTRACT:**In the present study an experimental work had been carried out to analyze the performance and emission characteristics of various blends of Thevetia Peruviana biodiesel by varying injection pressure. The engine tests are conducted on Kirloskar, 5.2 kW, 4-stroke, single cylinder, 1500 rpm, water cooled, direct injection, diesel engine with eddy current dynamometer with standard injection timing 23°bTDC was maintained constant throughout the experiment. Three different injection pressures such as 210 bar, 230 bar, 250 bar varied to analyze the performance and emission characteristics. From the test results, it could be observed that among three different injection pressures 230 bar injection pressure gives higher thermal efficiency, lower fuel consumption and lower emissions.

**KEYWORDS:**Blends, Compression ignition, Emission, injection pressure, Performance.

## I. INTRODUCTION

Under Indian conditions plant varieties, which are non-edible and which can be grown abundantly in large-scale on waste lands, can be considered for biodiesel production [1]. Some of the prominent non-edible oil seed producing plants include *Jatropha curcas*, *Pongamia pinnata*, *Neem* and *Rubber seed* etc. In this research work, biodiesel production from a new plant source called *Thevetia Peruviana* has been investigated [2]. Due to rapid population growth and economic development, the worldwide energy demand is constantly increasing [3]. The energy demand is fulfilled mainly from the conventional energy resources like coal, petroleum and natural gas [4]. But, the petroleum reserves concentrated in certain regions of the world are fast depleting day by day and at the current usage rate, these sources will soon be exhausted [5]. Recently, due to the shortage of fossil fuels throughout the world, crude oil price increase and contribution of these fuels to pollute the environment, biodiesel is being attracting increasing attention worldwide as a potential alternative and renewable fuel for diesel engines [6]. Biodiesel, an alternative and renewable fuel for diesel engines, consists of mono-alkyl esters of long chain fatty acids, more commonly methyl esters and is typically made from nontoxic, biological resources such as edible and non-edible vegetable oils, animal fats, waste cooking oils and oil from algae by transesterification with methanol [7]. Biodiesel has been chosen as one of the interesting alternative fuels and has been receiving a lot of attention throughout the world as it is renewable, biodegradable, nontoxic and environment-friendly fuel [8]. Biodiesel produces lower emissions, possesses high flash point, better lubrication and high cetane number and has very close physical and chemical characteristics to those of conventional diesel fuel allowing its use either on its own or mixed with petroleum based diesel fuel with very few technical adjustments or no modification [9]. Burning of biodiesel fuel does not contribute to a rise in the level of carbon dioxide in the atmosphere and consequently to the greenhouse effect [10]. The biodiesel produced from the renewable resources could help to minimize the fossil fuel burning and CO<sub>2</sub> production [11]. Biofuels and bio products produced from plant

# International Journal of Innovative Research in Science, Engineering and Technology

(A High Impact Factor, Monthly, Peer Reviewed Journal)

Visit: [www.ijirset.com](http://www.ijirset.com)

Vol. 7, Issue 8, August 2018

biomass mitigate global warming [12]. This may be due to the CO<sub>2</sub> released in burning equals the CO<sub>2</sub> tied up by the plant during photosynthesis and does not increase the net CO<sub>2</sub> in the atmosphere [13].

## II. PROPERTIES OF FUELS

Table 1 : Properties of fuels

Property	B0	B20	B40	B60	B80	B100
Density (kg/m <sup>3</sup> )	829	839	842	846	849	856
Viscosity at 40°C (CSt)	3.52	3.96	4.22	4.71	4.89	5.35
Flash Point (°C)	53	77	83	87	98	122
Fire Point (°C)	59	86	92	95	112	139
Calorific Value (MJ/kg)	42.19	41.45	40.92	40.31	39.98	39.25

## III. TRANSESTERIFICATION REACTION

It is most commonly used and important method to reduce the viscosity of vegetable oils. In this process triglyceride reacts with three molecules of alcohol in the presence of a catalyst producing a mixture of fatty acids, alkyl ester and glycerol. The process of removal of all the glycerol and the fatty acids from the vegetable oil in the presence of a catalyst is called esterification. The parameter such as temperature, molar ratio and catalyst concentration that affect the transesterification of raw oil were optimized initially. The transesterification set up houses 2 L Capacity, round bottom flask provided with three necks that was placed in a water container for heating the oil. A heater with a temperature regulator was placed in the round bottom flask. A high speed motor with a magnetic stirrer was used for vigorous mixing of the oil. In the transesterification process triglycerides of raw oil reacts with methyl alcohol in the presence of catalyst (NaOH) to produce a fatty acid ester and glycerol. In this process 1000 g raw oil, 230 g methanol and 8 g sodium hydroxide pellets were placed in the round bottom flask. The contents were heated to 70°C and stirred vigorously for one hour to promote ester formation. The mixture was next transferred to a separating funnel and allowed to settle under gravity overnight. The upper layer in the separating funnel consists of ester whilst the lower layer is glycerol which was removed. The separated ester with 250 g hot water and allowed to settle under gravity for 24 hours. Water washing separates residual fatty acids and catalyst and these were removed using a separating funnel. Finally the moisture from the ester was removed by adding silica gel crystals.

## IV. EXPERIMENTAL SETUP

A single cylinder, direct injection, four-stroke, water cooled, Compression Ignition (CI) engine is used in the experimental study. The fuel flow rate was measured by noting down the time taken for the consumption of a known quantity of fuel (10cc) from a burette. The viscosity of raw as well as esterified oil was measured by red wood viscometer, density by hydrometer, calorific value by bomb calorimeter, flash and fire point by open cup method. Initially, before starting experimental tests, the engine was made to run under ideal condition as warm up phase and then the tests were conducted. The engine was started and allowed to warm-up for about 10 minutes. The engine was tested under five discrete part load conditions i.e. 20%, 40%, 60%, 80% and 100%.

# International Journal of Innovative Research in Science, Engineering and Technology

(A High Impact Factor, Monthly, Peer Reviewed Journal)

Visit: [www.ijirset.com](http://www.ijirset.com)

Vol. 7, Issue 8, August 2018

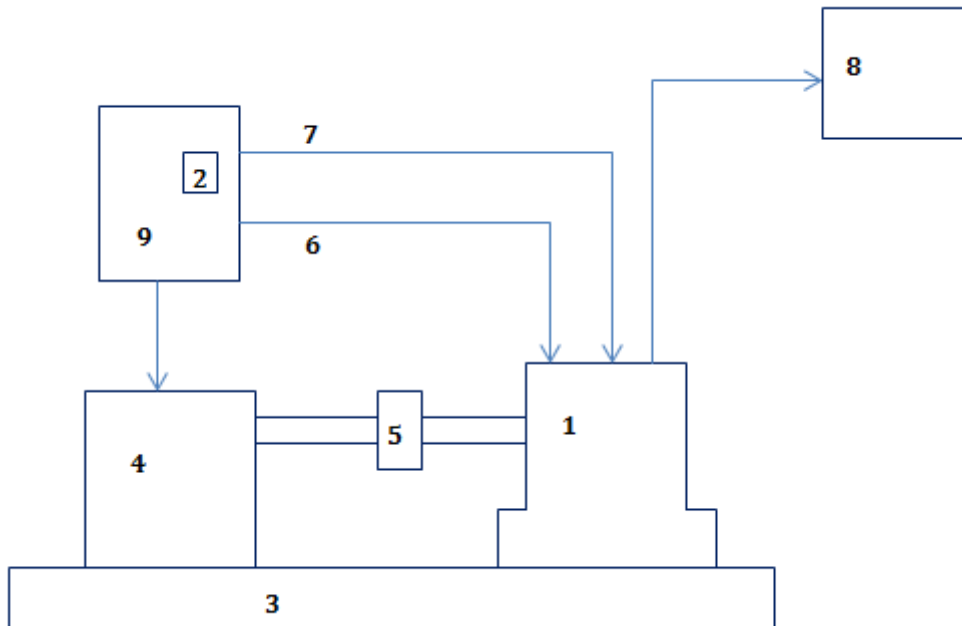

Fig 1 : Experimental Setup

1-Diesel engine, 2-Burette for fuel measurement, 3-Base, 4-Dynamometer, 5-Coupling, 6-Air supply line, 8-Exhaust gas analyzer, 9-Control panel

## V. ENGINE PARAMETERS

Table 2 : Engine parameters

Engine Parameter	Specifications
Engine Type	Kirloskar
No. of Strokes	4
No. of Cylinders	1
Type of Cooling	Water Cooling
Type of Injection	Direct Injection
Bore	87.5 mm
Stroke	110 mm
Compression Ratio	17.5:1
Rated Power	5.2 kW
Rated Speed	1500 rpm
Injection Pressure	210 bar
Injection Timing	23° BTDC

# International Journal of Innovative Research in Science, Engineering and Technology

(A High Impact Factor, Monthly, Peer Reviewed Journal)

Visit: [www.ijirset.com](http://www.ijirset.com)

Vol. 7, Issue 8, August 2018

## VI. RESULTS AND DISCUSSION

### Optimization of blend

#### Brake thermal efficiency

Variation of brake thermal efficiency with brake power for all the fuels tested as shown in Fig 2. For all the fuels tested the brake thermal efficiency increases with increase in load. This is due to, reduction in heat loss and increase in power with increase in load. The brake thermal efficiency of biodiesel blends was found to be lower compared to diesel at all power output. This is due to, the lower calorific value, higher viscosity, higher density which leads to poor atomization of biodiesel than diesel which results into increase of brake thermal efficiency for diesel than biodiesel blends. At 80% load condition all tested fuels give higher brake thermal efficiency than at 100% load condition. This is due to the fact that, the power produced from the engine is less than the amount of fuel consumed to develop that power at 100% load condition so that brake thermal efficiency decreases at 100% load condition as compared to 80% load condition.

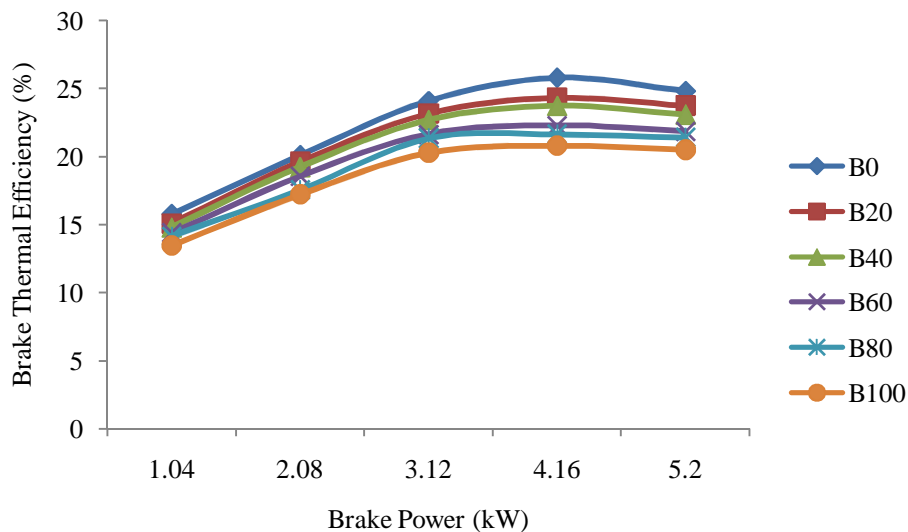

Fig 2 : Variation of brake thermal efficiency with brake power

#### Brake specific fuel consumption

Variation of brake specific fuel consumption with brake power for all the fuels tested as shown in Fig 3. As the load increases brake specific fuel consumption decreases. It is observed that brake specific fuel consumption for biodiesel blends is higher when compared with diesel. For effective burning of the fuel the calorific value of the fuel should be higher so that the evaporation of the fuel is also high. The calorific values of blends of biodiesel are lower when compared with diesel; hence the fuel evaporation is slower. Slower evaporation rates leads to higher brake specific fuel consumption.

# International Journal of Innovative Research in Science, Engineering and Technology

(A High Impact Factor, Monthly, Peer Reviewed Journal)

Visit: [www.ijirset.com](http://www.ijirset.com)

Vol. 7, Issue 8, August 2018

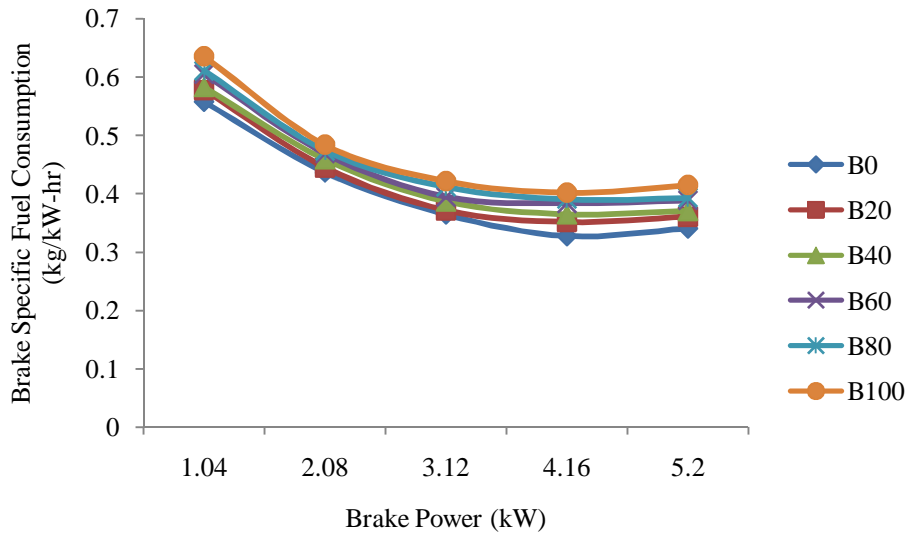

Fig 3 : Variation of brake specific fuel consumption with brake power

## Total fuel consumption

Variation of total fuel consumption with brake power for all the fuels tested as shown in Fig 4. As the load increases total fuel consumption increases for all fuels tested. Total fuel consumption for diesel is less as compared to biodiesel blends. This is due to higher viscosity, higher density which leads to higher fuel consumption of biodiesel than diesel.

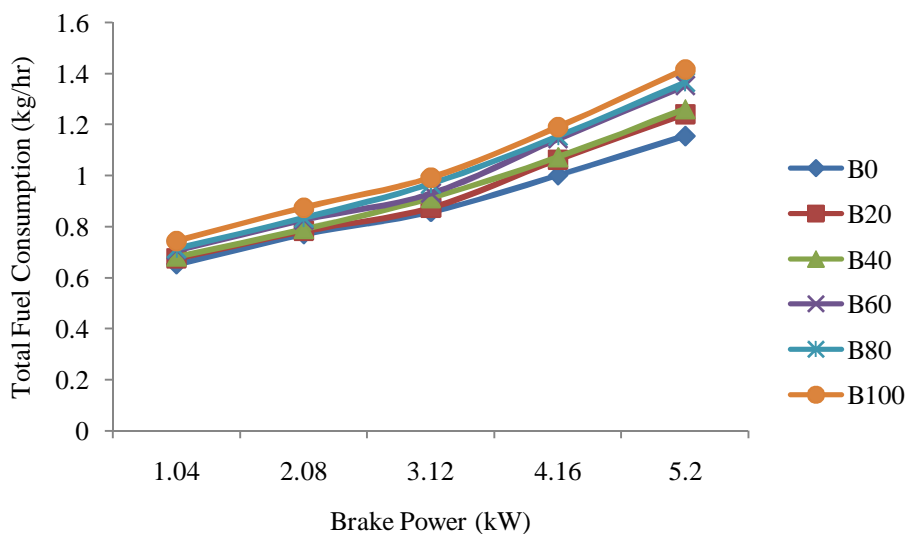

Fig 4 : Variation of total fuel consumption with brake power

# International Journal of Innovative Research in Science, Engineering and Technology

(A High Impact Factor, Monthly, Peer Reviewed Journal)

Visit: [www.ijirset.com](http://www.ijirset.com)

Vol. 7, Issue 8, August 2018

## HC emissions

The variation of hydrocarbon emissions with brake power for different blends of biodiesel as shown in Fig 5. The neat diesel exhibit lower amount of hydrocarbon emissions as compared to biodiesel blends. This is mainly due to, higher viscosity of biodiesel blends which leads to poor mixing of fuel and air results into incomplete combustion.

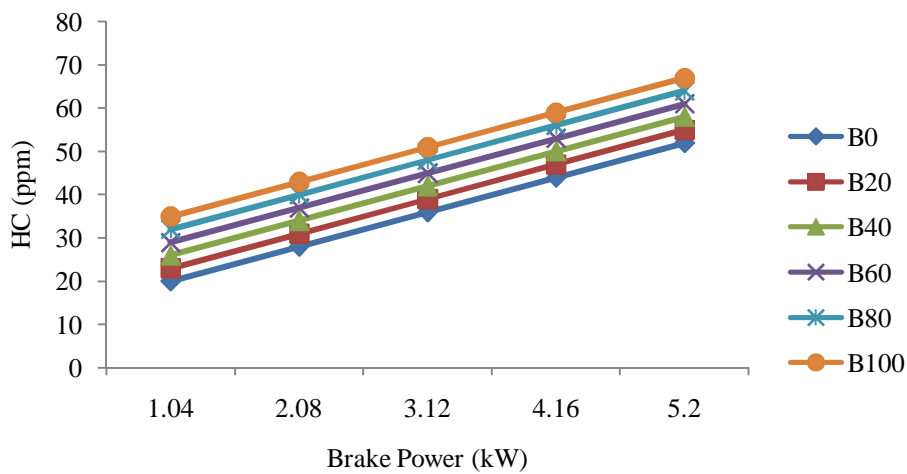

Fig 5 : Variation of HC emission with brake power

## CO emissions

The variation of carbon monoxide emissions with brake power for different blends of biodiesel as shown in Fig 6. The neat diesel exhibit lower amount of carbon monoxide emissions as compared to biodiesel blends. This is mainly due to, higher viscosity of biodiesel blends which leads to poor mixing of fuel and air results into incomplete combustion.

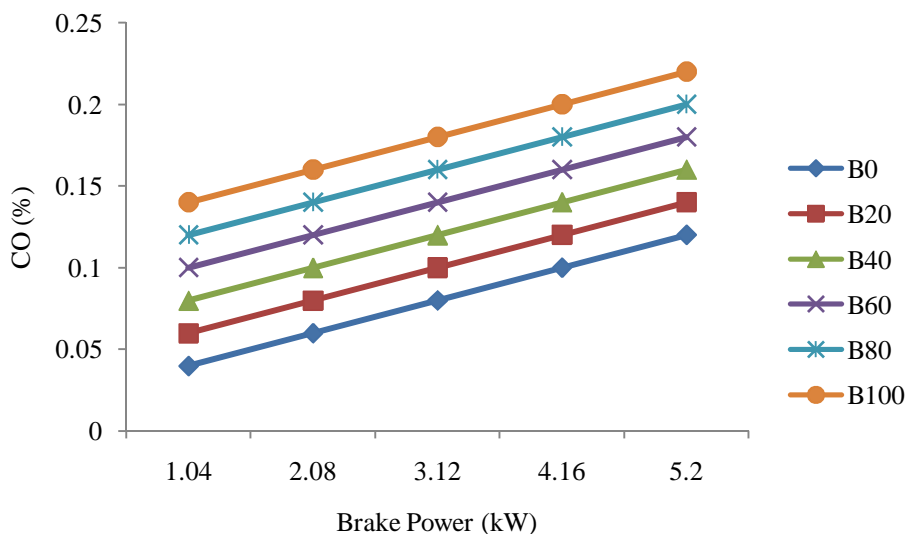

Fig 6 : Variation of CO emission with brake power

# International Journal of Innovative Research in Science, Engineering and Technology

(A High Impact Factor, Monthly, Peer Reviewed Journal)

Visit: [www.ijirset.com](http://www.ijirset.com)

Vol. 7, Issue 8, August 2018

## NOx emissions

The variation of nitrogen oxide emissions with brake power for different blends of biodiesel as shown in Fig 7. The neat diesel exhibit higher amount of nitrogen oxide emissions as compared to biodiesel blends. This is mainly due to, diesel having higher calorific value and lower viscosity than biodiesel blends. This results into better mixing of fuel and air which leads into complete combustion of fuel. The complete combustion of fuel results higher peak pressure rise rate and higher exhaust gas temperature which leads to higher value of nitrogen oxide emissions than biodiesel blends.

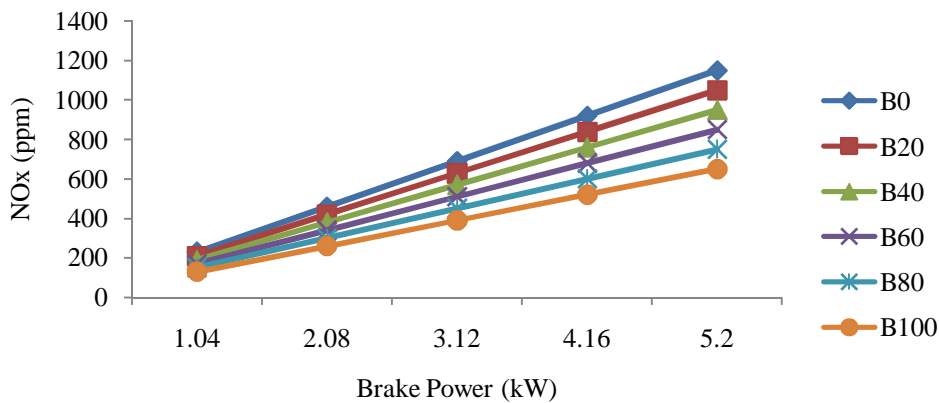

Fig 7 : Variation of NOx emission with brake power

## Soot emissions

The variation of smoke opacity with brake power for different blends of biodiesel as shown in Fig 8. The neat diesel exhibit lower amount of smoke opacity as compared to biodiesel blends. This is due to, higher viscosity of biodiesel blends the atomization of fuel becomes poor and this leads to higher smoke emissions.

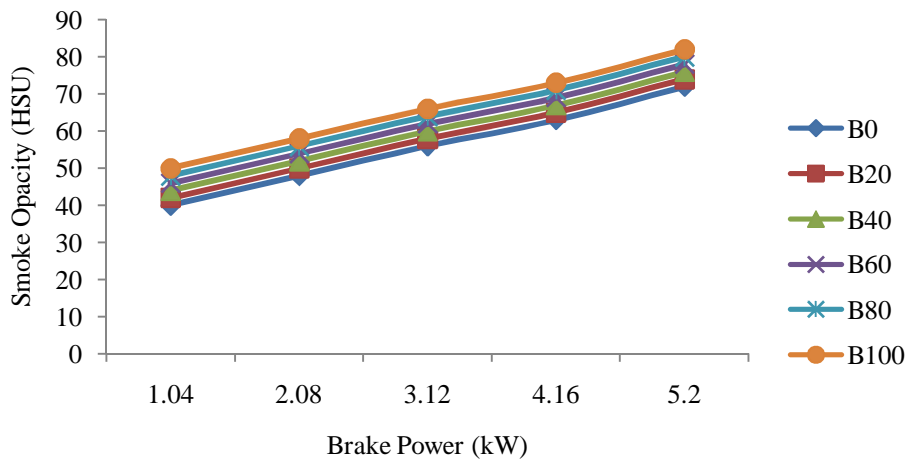

Fig 8 : Variation of smoke opacity with brake power

# International Journal of Innovative Research in Science, Engineering and Technology

(A High Impact Factor, Monthly, Peer Reviewed Journal)

Visit: [www.ijirset.com](http://www.ijirset.com)

Vol. 7, Issue 8, August 2018

## Optimization of injection pressure

### Brake thermal efficiency

Fig 9 shows variation of brake thermal efficiency with injection pressure. Among all the blends tested B0 blend gives higher brake thermal efficiency because of higher calorific value of the B0 blend. Among different injection pressures tested 230 bar gives the higher brake thermal efficiency because with the increase in injection pressure from 210 bar to 230 bar there is fine atomization of fuel so that there is better mixing of fuel and air and hence brake thermal efficiency increases. Again if injection pressure increases from 230 bar to 250 bar then there is decrease in BTE. This is due to the fact that, with increase in injection pressure beyond the limit not only fuel droplet size decreases but also momentum of the fuel droplets increases. These droplets impinged on the cylinder wall and hence fuel consumption increases and it leads to lower brake thermal efficiency.

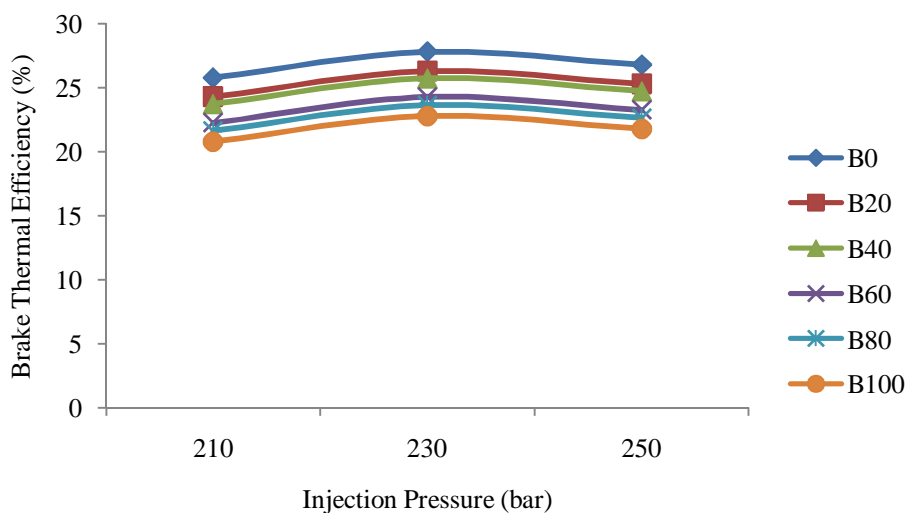

Fig 9 : Variation of brake thermal efficiency with injection pressure

### Brake specific fuel consumption

Fig 10 shows variation of brake specific fuel consumption with injection pressure. Among all the blends tested B0 blend gives lower brake specific fuel consumption because of lower viscosity of the B0 blend. Among different injection pressures tested 230 bar gives the lower brake specific fuel consumption because with the increase in injection pressure from 210 bar to 230 bar there is fine atomization of fuel so that there is better mixing of fuel and air and hence brake specific fuel consumption decreases. Again if injection pressure increases from 230 bar to 250 bar then there is increase in BSFC. This is due to the fact that, with increase in injection pressure beyond the limit not only fuel droplet size decreases but also momentum of the fuel droplets increases. These droplets impinged on the cylinder wall and hence fuel consumption increases.



# International Journal of Innovative Research in Science, Engineering and Technology

(A High Impact Factor, Monthly, Peer Reviewed Journal)

Visit: [www.ijirset.com](http://www.ijirset.com)

Vol. 7, Issue 8, August 2018

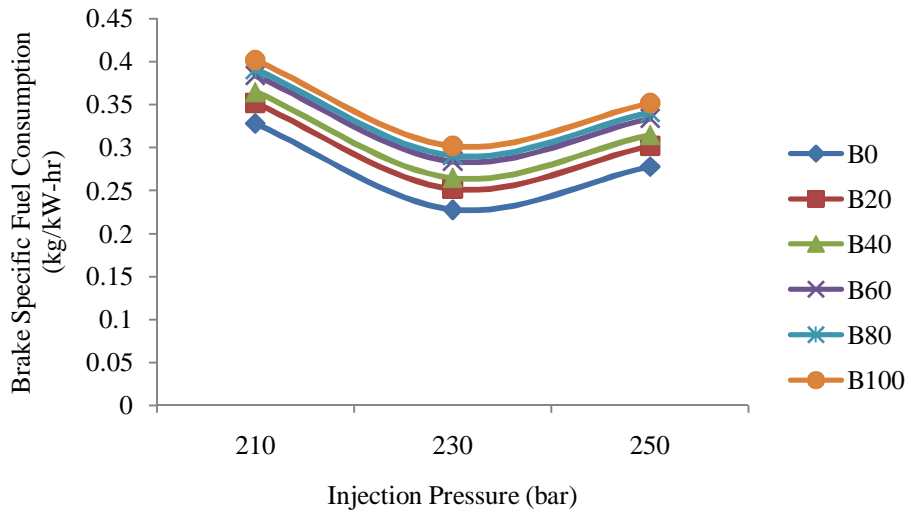

Fig 10 : Variation of brake specific fuel consumption with injection pressure

## Total fuel consumption

Fig 11 shows variation of total fuel consumption with injection pressure. Among all the blends tested B0 blend gives lower total fuel consumption because of lower viscosity of the B0 blend. Among different injection pressures tested 230 bar gives the lower total fuel consumption because with the increase in injection pressure from 210 bar to 230 bar there is fine atomization of fuel so that there is better mixing of fuel and air and hence total fuel consumption decreases. Again if injection pressure increases from 230 bar to 250 bar then there is increase in total fuel consumption. This is due to the fact that, with increase in injection pressure beyond the limit not only fuel droplet size decreases but also momentum of the fuel droplets increases. These droplets impinged on the cylinder wall and hence fuel consumption increases.

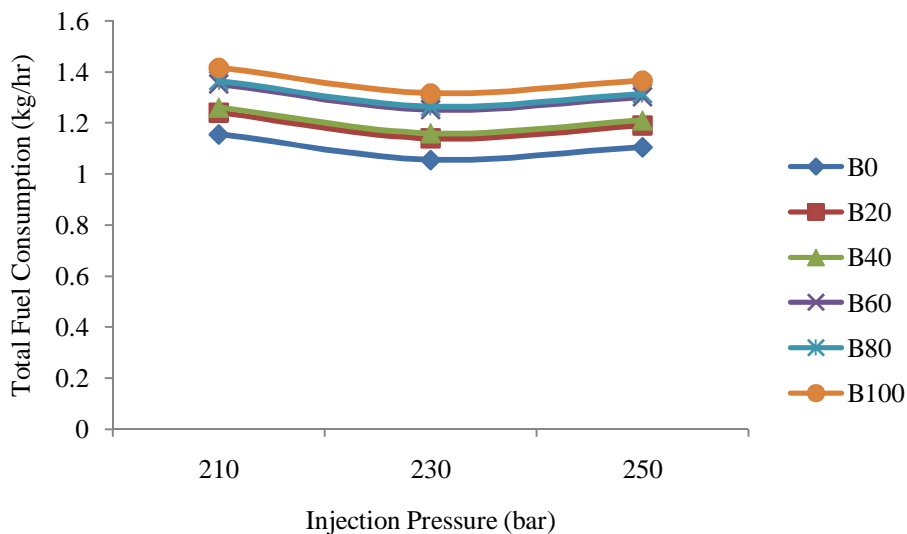

Fig 11 : Variation of total fuel consumption with injection pressure

# International Journal of Innovative Research in Science, Engineering and Technology

(A High Impact Factor, Monthly, Peer Reviewed Journal)

Visit: [www.ijirset.com](http://www.ijirset.com)

Vol. 7, Issue 8, August 2018

## HC emissions

Fig 12 shows variation of HC emission with injection pressure. Among all the blends tested B0 blend gives lower HC emission because of effective burning of the B0 blend. Among different injection pressures tested 230 bar gives the lower HC emission because with the increase in injection pressure from 210 bar to 230 bar there is fine atomization of fuel so that there is better mixing of fuel and air and hence HC emission decreases. Again if injection pressure increases from 230 bar to 250 bar then there is increase in HC emission. This is due to the fact that, with increase in injection pressure beyond the limit not only fuel droplet size decreases but also momentum of the fuel droplets increases. These droplets impinged on the cylinder wall and hence HC emission increases.

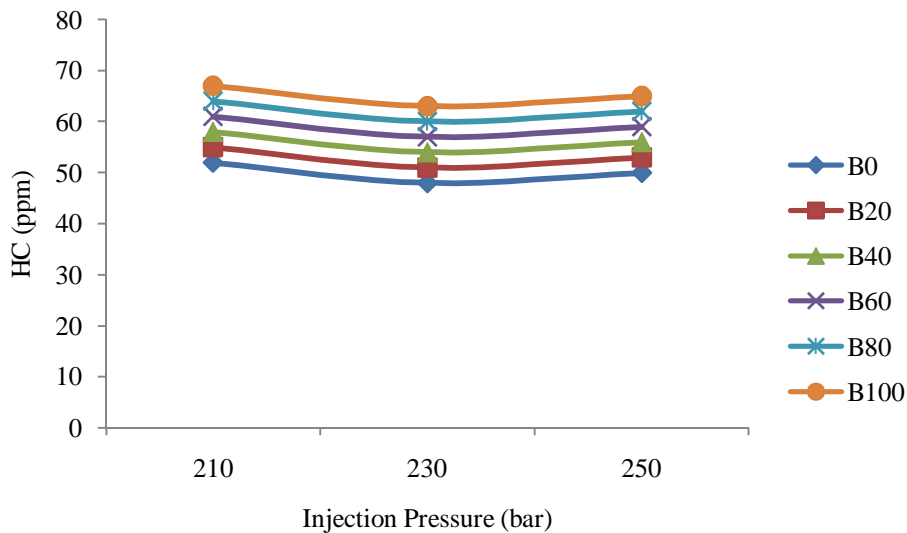

Fig 12 : Variation of HC emissions with injection pressure

## CO emissions

Fig 13 shows variation of CO emission with injection pressure. Among all the blends tested B0 blend gives lower CO emission because of effective burning of the B0 blend. Among different injection pressures tested 230 bar gives the lower CO emission because with the increase in injection pressure from 210 bar to 230 bar there is fine atomization of fuel so that there is better mixing of fuel and air and hence CO emission decreases. Again if injection pressure increases from 230 bar to 250 bar then there is increase in CO emission. This is due to the fact that, with increase in injection pressure beyond the limit not only fuel droplet size decreases but also momentum of the fuel droplets increases. These droplets impinged on the cylinder wall and hence CO emission increases.

# International Journal of Innovative Research in Science, Engineering and Technology

(A High Impact Factor, Monthly, Peer Reviewed Journal)

Visit: [www.ijirset.com](http://www.ijirset.com)

Vol. 7, Issue 8, August 2018

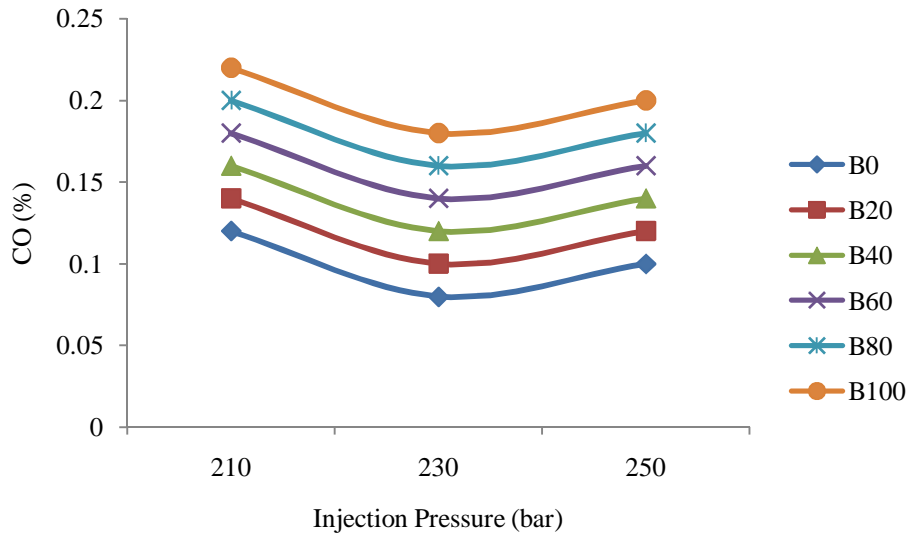

Fig 13 : Variation of CO emission with injection pressure

## NOx emissions

Fig 14 shows variation of NOx emission with injection pressure. Among all the blends tested B0 blend gives higher NOx emission because of effective burning of the B0 blend. Among different injection pressures tested 230 bar gives the higher NOx emission because with the increase in injection pressure from 210 bar to 230 bar there is fine atomization of fuel so that there is better mixing of fuel and air and hence NOx emission increases. Again if injection pressure increases from 230 bar to 250 bar then there is decrease in NOx emission. This is due to the fact that, with increase in injection pressure beyond the limit not only fuel droplet size decreases but also momentum of the fuel droplets increases. These droplets impinged on the cylinder wall and hence NOx emission decreases.

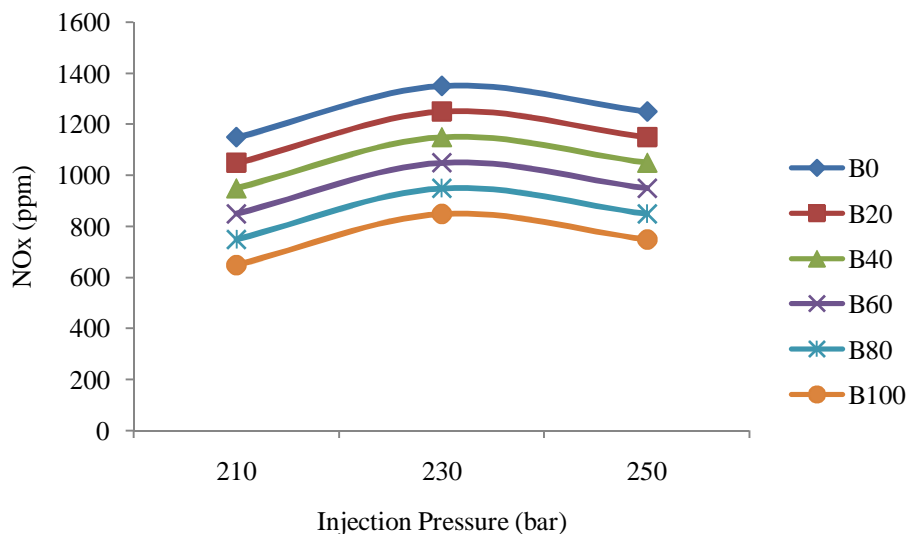

Fig 14 : Variation of NOx emission with injection pressure

## Soot emissions

## International Journal of Innovative Research in Science, Engineering and Technology

(A High Impact Factor, Monthly, Peer Reviewed Journal)

Visit: [www.ijirset.com](http://www.ijirset.com)

Vol. 7, Issue 8, August 2018

Fig 15 shows variation of soot emission with injection pressure. Among all the blends tested B0 blend gives lower soot emission because of effective burning of the B0 blend. Among different injection pressures tested 230 bar gives the lower soot emission because with the increase in injection pressure from 210 bar to 230 bar there is fine atomization of fuel so that there is better mixing of fuel and air and hence soot emission decreases. Again if injection pressure increases from 230 bar to 250 bar then there is increase in soot emission. This is due to the fact that, with increase in injection pressure beyond the limit not only fuel droplet size decreases but also momentum of the fuel droplets increases. These droplets impinged on the cylinder wall and hence soot emission increases.

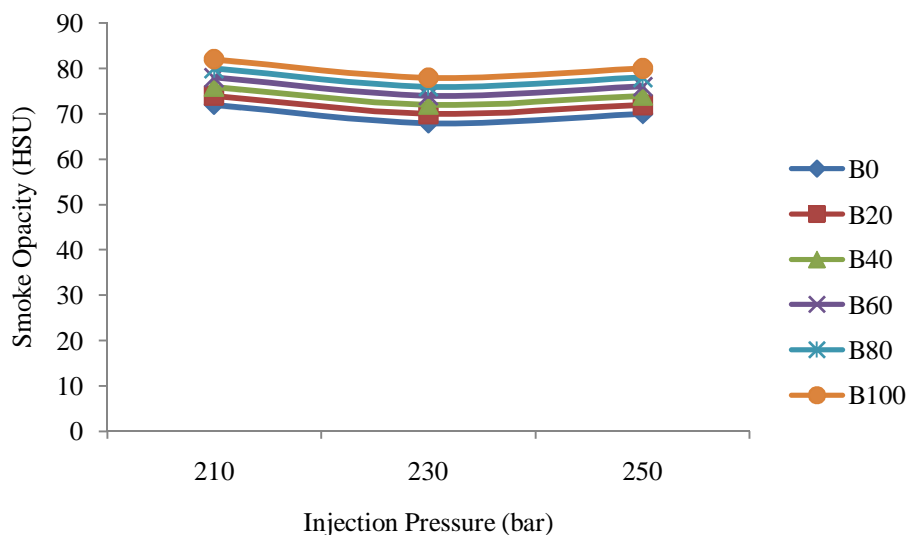

Fig 15 : Variation of smoke opacity with injection pressure

### VII. CONCLUSIONS

The brake thermal efficiency of biodiesel blends was found to be lower compared to diesel at all power output. Total fuel consumption for diesel is less as compared to biodiesel blends. Brake specific fuel consumption for blends of biodiesel blends is higher when compared with diesel. HC, CO and soot emissions for diesel are lower as compared to biodiesel blends. NO<sub>x</sub> emissions are higher for diesel as compared to biodiesel blends. Among the biodiesel blends tested, B20 gave the best performance with reduced emissions. The brake thermal efficiency of the engine with the B20 blend at 80% power output which is closer to diesel operation. Hence B20 blend is recommended for existing diesel engine. At all injection pressure tested 230 bar injection pressure gives higher brake thermal efficiency, lower brake specific fuel consumption, lower HC, CO and soot emissions and higher NO<sub>x</sub> emissions. Hence 230 bar injection pressure is recommended for existing diesel engine.

### REFERENCES

1. Temitayo. (2017). Optimization of oil extraction from thevetia peruviana (yellow oleander) seeds. International Journal of Engineering and Modern Technology, 3(4), 25-42.
2. Pattanaik, Sahoo, Naik. (2017). Thevetia peruviana a non-edible biodiesel feedstock. Journal of Thermal Energy Systems, 2(1), 47-55.
3. Eboka, Inambo. (2017). Production properties studies of tropical thevetia peruviana and Jatropha curcas biodiesel using biometallic salts as catalyst. Proceedings of the World Congress on Engineering and Computer Science, 2, 1-7.
4. Raj, Manokar. (2016). Combustion characteristics of di-ethyl ether mixed thevetia peruviana seed oil. Journal of Chemical and Pharmaceutical Research, 8(7), 424-430.
5. Jabar, Lajide, Bakare, Oloye. (2016). Extraction and characterization of vegetable oil from thevetia peruviana and Jatropha curcas seeds. Journal of Research in Sciences, 1, 73-80.

# International Journal of Innovative Research in Science, Engineering and Technology

(A High Impact Factor, Monthly, Peer Reviewed Journal)

Visit: [www.ijirset.com](http://www.ijirset.com)

Vol. 7, Issue 8, August 2018

6. Panchal, Deshmukh, Sharma. (2016). Biodiesel from thevetia peruviana seed oil with dimethyl carbonate using as an active catalyst potassium methoxide. *Sains Malaysiana*, 45(10), 1461-1468.
7. Madhura, Arulnithy, Mathiventhan. (2016). Yellow oleander seed poisoning in the batticaloa district, srilanka was related with fruiting season. *International Journal of Research Studies in Biosciences*, 4(8), 8-13.
8. Godson, Bassey. (2015). Characterization of oil and biodiesel produced from thevetia peruviana seeds. *International Journal of Sustainable and Green Energy*, 4(4), 150-158.
9. Adamu, Jahun, Daniel. (2015). Assessment and optimization of energy use of yellow oleander (thevetia peruviana) for biodiesel blends in Nigeria. *International Journal of Science and Research*, 4(11), 1277-1280.
10. Basumatary. (2015). Yellow oleander (thevetia peruviana) seed oil biodiesel as an alternative and renewable fuel for diesel engine. *International Journal ChemTech Research*, 7(6), 2823-2840.
11. Lawrence, Banjoko, Oluwabunmi, Mosebolatan, Funmilola. (2014). Extraction and characterization of oil from thevetia peruviana seeds (yellow oleander) using n-hexane as a solvent. *Proceedings of the International Conference on Science, Technology, Education, Arts, Management and Social Sciences*, 195-202.
12. Basumatary, Deka. (2014). Transesterification of yellow oleander (thevetia peruviana) seed oil to fatty acid methyl ester using heterogeneous catalyst derived from rhizome of musabalbisanacolla. *International Journal ChemTech Research*, 6(4), 2377-2384.
13. Ezekwe, Ajiwe. (2014). The effect of temperature on the viscosities of biofuels from thevetia, gourd and bush melon. *International Journal of Recent Scientific Research*, 5(3), 611-617.
14. Titus, Abuduganiy, Taofik. (2013). The evaluation of some physical and thermal properties of thevetia peruviana as affected by days of storage. *International Journal of Scientific and Engineering Research*, 4(1), 1-11.
15. Yarkasuwa, Wilson, Michael. (2013). Production of biodiesel from yellow oleander (thevetia peruviana) oil and its biodegradability. *Journal of the Korean Chemical Society*, 57(3), 377-381.
16. Singh, Agrawal, Mishra, Uddin, Shukla. (2012). A review on thevetia peruviana. *International Research Journal of Pharmacy*, 3(4), 74-77.
17. Dhoot, Jaju, Deshmukh, Panachal, Sharma. (2011). Extraction of thevetia peruviana seed oil and optimization of biodiesel production using alkali-catalyzedmethanolysis. *Journal of Alternate Energy Sources and Technologies*, 2(2), 8-16.
18. Harari, Akshatha, Manavendra. (2015). Effect of Injection Pressure and Nozzle Hole Diameter on Combustion Parameters of CI Engine Fuelled with B20 Neem Blend, *International Journal of Innovative Research in Science, Engineering and Technology*, 4(5), 2857-2870.
19. Mansukh, Jadhav, Patil, Nichite, Harari, Bhagwat. (2016). Experimental investigation on the production of biodiesel from various oils and determine various properties. *International Journal of Engineering and Management Research*, 6(2), 666-670.
20. Harari, Kokku. (2016). Experimental Investigation on the Performance Characteristics of Compression Ignition Engine Fuelled with various Blends of Nerium Biodiesel, *Imperial Journal of Interdisciplinary Research*, 2(9), 1015-1020.
21. Harari, Ghadge. (2016). Experimental Investigation on the Performance Characteristics of Compression Ignition Engine Fuelled with Various Blends of Calophyllum Inophyllum Biodiesel, *International Research Journal of Engineering and Technology*, 3(8), 752-757.
22. Harari. (2017). Experimental Investigation on the Performance and Emission Characteristics of Compression Ignition Engine Fuelled with Various Blends of Water Melon Biodiesel, *Integrated Research Advances*, 4(1), 18-23.
23. Harari, Pattanashetti. (2017). Experimental Investigation on the Effect of Injection Timing, Carburetor Type and Exhaust Gas Recirculation on Compression Ignition Engine Fuelled with Diesel – Compressed Biogas and Rice Bran Oil Methyl Ester – Compressed Biogas, *Integrated Research Advances*, 4(2), 29-36.