

Recent Advances on Desalination Technologies

Abdulkarim Mayere

Sokoto Energy Research Centre, Usmanu Danfodio University, Sokoto, Nigeria.

ABSTRACT: The literature associated with water desalination is presented here. An assessment of the global water crises was carried out base on the availability and consumption of water, water scarcity and possible solutions. Hence the review of desalination as one possible solution to the growing crises due to scarcity of nature’s most abundant resource. This includes a review of growing trend in adopting desalination for fresh water supply. Various technologies for water desalination are presented. The suitability of integrating renewable energy sources to desalination is explored. And finally the cost of desalination and market opportunities are analysed.

KEYWORDS: Desalination, Renewable energy, market opportunities

I. INTRODUCTION

Water is the essence of life and a fundamental need for human existence. About 70% of the surface of the earth is covered with water. However, up to 97% of earth’s water is salt water from the oceans with salinity up to 30,000 parts per million of total dissolved solids (ppm TDS). Only 3% of the earth’s water is fresh water. Freshwater according to the World Health Organisation (WHO) can be defined as water with less than 500ppm TDS. Most of the fresh water comes from ground water sources such as wells, or from surface waters such as rivers, lakes and reservoirs. The distribution of earth’s water is shown in figure 1.

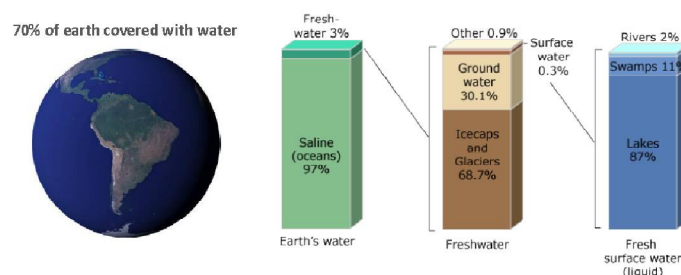

Figure 1. Distribution of earth’s water (US Geological Survey) [1]

There have been various estimates of the global water resource base on different calculation methods [2]. Shiklomanov in Gleick (1993) calculated the total volume of water in the world to be approximately $1.4 \times 10^{18} \text{ m}^3$. Surface freshwater is $1.05 \times 10^{14} \text{ m}^3$ or 0.3% of the world's freshwater [3]. Niemczynowicz (2000) estimated more than 50% of the surface freshwater as non renewable water [4]. The amount of renewable water is therefore around $4.2 \times 10^{13} \text{ m}^3$ per year which replenishes groundwater source or returns to the oceans by rivers. Most of it (around $3 \times 10^{13} \text{ m}^3$ per year) is in flush flows that are not captured by man. It is assumed that the available renewable freshwater resource is between 9×10^{12} and $14 \times 10^{12} \text{ m}^3$ per year. However around 70% of is required for the ecosystem and thus only 30% or $4.2 \times 10^{12} \text{ m}^3$ per year is available for human consumption [5]. The balance between availability of fresh water and demand has reached critical level. If the world is to depend only on freshwater source, soon any form of life will face extinction. According to International Desalination Association (IDA), humans use as little as 0.02m^3 (20 litres) of water a day for domestic use in the developing countries to as high as 0.2m^3 (200 litres) in the developed countries. And although a lot of water is consumed by industry, the largest use of water is for producing the products we eat and wear. Consider these facts [6]; it takes 0.245m^3 (245 litres) of water to produce 0.25kg of wheat. It takes 2.7m^3 (2700 litres) of water to

International Journal of Innovative Research in Science, Engineering and Technology

(A High Impact Factor, Monthly, Peer Reviewed Journal)

Visit: www.ijirset.com

Vol. 7, Issue 9, September 2018

produce an average size cotton shirt. Around 1.23m³ (1230 litres) is required to produce 0.25kg of cheese. And 13m³ (13000 litres) of water is needed to produce 1kg of beef. Agriculture uses up to 70 times more water to produce food than is used in drinking and other domestic purposes, including cooking, washing and bathing.

II. MEASURING WATER AVAILABILITY

There are several methods of measuring water availability. The most widely used method is Falkenmark's per capita index. This is the relationship between the available water resource and the population. Falkenmark projected about 0.1m³ (100 litres) per person per day is the rough minimum required for domestic needs. And 5 to 20 times of the domestic need is required to meet the demands of the agricultural and industrial sectors [7]. Hence a benchmark which indicates water stress and water scarcity was established. A country is said to be water stressed when availability per capita is between 1000 to 1700m³ per year. And anything below 1000m³ per year per capita is regarded as water scarcity. The benchmark was further divided into four main categories by Schram (1999) as shown in Table 1 [5]. It should be noted that the Falkenmark's concept do not account for other factors which include non renewable water sources and virtual water. It only accounts for renewable water from rainfall or snow. Bearing in mind the world major rivers drying up, depletion of groundwater level and melting glaciers, it can be concluded that the approximation is generous. One advantage of the approximation is that data is widely available. And hence the concept is widely accepted by big organizations such as the United Nations.

Table 1. Water per capita index

Renewable fresh water per capita [m ³ per year]	Effects
>1700	Limited stress
1700-1000	Water stressed
1000-500	Water scarce
<500	Absolute scarcity

III. DESALINATION AS A SOLUTION TO WATER PROBLEM

Water conservation is a very crucial part of the overall water strategy. Every drop of water that is used is another drop in supply. It is very much encouraged to strengthen conservation efforts before turning to desalination. But in many communities additional water supply is needed even after they have fully considered the conservation measures. There are in fact communities around the world that rely 100% on desalinated water for their supply. Hence desalination technique is the most promising solution to supply some remote regions with fresh water. Desalination is the process of removing salt from water. Over the past decade, the number of desalination plants and their total capacity has almost doubled [8]. The current production capacity exceeds 65 million m³ per day and the number of plants has increased to more than 14,000 units [9]. Saudi Arabia in Middle East has the largest installed capacity, and then followed by Spain in Europe and then USA in North America. All other top ten capacities are within the Middle East with Qatar and Kuwait depending 100% on desalination except Algeria and Libya in North Africa and then China in Asia [10].

IV. EXISTING DESALINATION TECHNOLOGIES

There are several desalination processes and most of them are reliable and in commercial use. The most important processes are divided into two classes; the thermal and the membrane processes. The thermal process is based on natural processes of distillation and usually involves heat transfer. Main thermal technologies are the multi-effect distillation (MED) and multi-stage flash (MSF). The membrane process is base on filtration through a membrane and usually driven by electricity. Major membrane technologies are electrodialysis (ED) and reverse osmosis (RO). Thermal processes produce water around 20 ppm TDS and membrane processes are usually designed to produce water

International Journal of Innovative Research in Science, Engineering and Technology

(A High Impact Factor, Monthly, Peer Reviewed Journal)

Visit: www.ijirset.com

Vol. 7, Issue 9, September 2018

of 100-500 ppm TDS while 1000 ppm TDS is the maximum limit for drinking water [5]. Other desalination technologies which are either not very common or are currently under research includes processes such as the membrane distillation, vapour compression and electrodeionization.

Membrane distillation (MD) combines the use of both thermal distillation and membranes. The process was introduced commercially on a small scale in 1980s. It primarily depends upon thermal evaporation and the use of membranes to pass vapour, which is then condensed to produce fresh water. In the process, saline water is warmed to enhance vapour production. This vapour is then exposed to a membrane that can pass water vapour but not liquid water. After the vapour passes through the membrane, it is condensed on a cooler surface to produce fresh water. In the liquid form, the fresh water cannot pass back through the membrane, so it is trapped and collected as the output of the plant [11]. The process of MD is illustrated in figure 2.

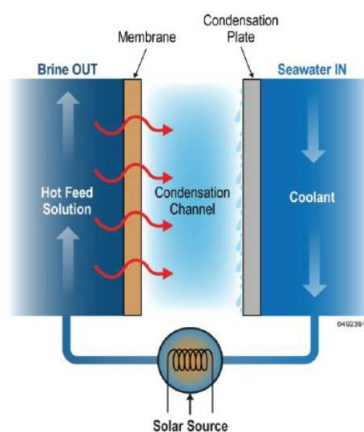

Figure 2. Principle of membrane distillation [12]

MD has been used only in a few facilities, since it requires more space, more pumping energy per unit of fresh water produced, and more money and other approaches. The main advantages of MD lie in its simplicity and the need for only small temperature differentials to operate. Commercially it is of little significance.

In Vapour Compression (VC) technique, the mechanism is similar to MED except that the heat for evaporating the water comes from the compression of vapour rather than the direct exchange of heat from vapour produced in a boiler. They are usually built in relatively small units ranging from a few litres up to 3000m³ per day [13]. It has high energy requirement and capital cost compared to other technologies. VC desalination process is illustrated in figure 3.

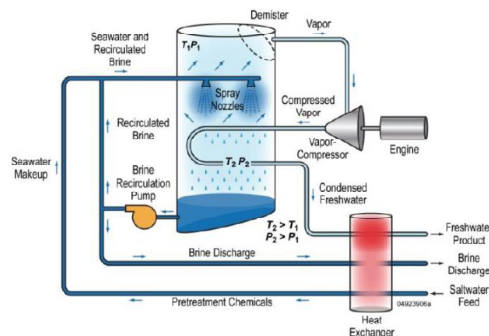

Figure 3. Vapour compression desalination system [12]

International Journal of Innovative Research in Science, Engineering and Technology

(A High Impact Factor, Monthly, Peer Reviewed Journal)

Visit: www.ijirset.com

Vol. 7, Issue 9, September 2018

Electrodeionisation (EDI) is a modification of electrodialysis that combines ion exchange and membrane filtration. In this process, ions are removed using conventional ion exchange resin. However, an electric current allows the continuous regeneration of the resin eliminating the elution stage which induces addition of chemical reagents [14]. The main advantages of the EDI process include continuous operation, stable product quality, and the ability to produce high purity water without the need of chemical regeneration [15]. However, the principal application of EDI is limited to the further purification of water obtained from reverse osmosis. Figure 4 shows process of EDI.

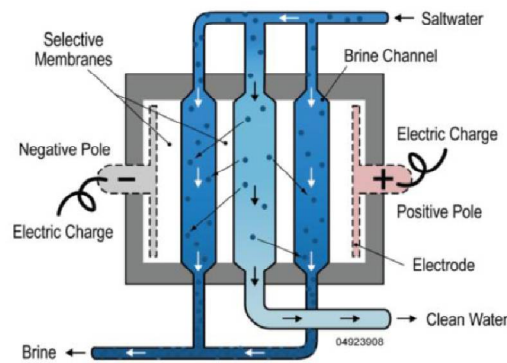

Figure 4. Principle of Electrodeionisation [12]

Figure 5 shows distribution of total worldwide installed capacity of desalination by technology. Each of the desalination technologies has its own unique advantage. However all desalination technologies are known to be highly energy intensive. The investment and operation costs are also very high. And finally the discharge of large amount of high concentration salt known as brine can have effect on the environment.

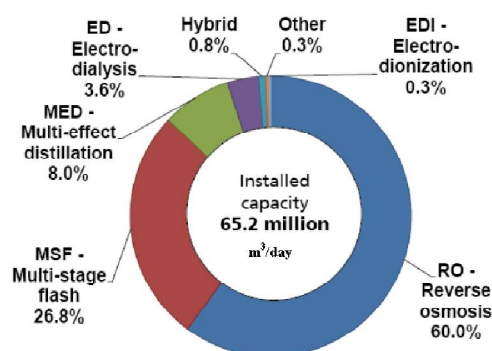

Figure 5. Total installed capacity by technology [IDA Year Book 2010-2011]

Reverse Osmosis (RO)

Membrane processes represents the fastest growing process. In the reverse osmosis process, pressure is used for separation by forcing seawater to move through a membrane from a solution of saltwater to obtain fresh water. A diagram of RO process is illustrated in figure 6. In RO process, there is no need for heating or phase change. The major energy requirement is for pressurising the feed water. This pressure ranges from 10 to 25 bars for brackish water. Due to higher concentration of seawater, it requires pressure from 50 to 80 bars. A turbine could be used to recover most of the energy consumed. Hence the RO process consumes 3kWh/m³ energy for brackish water and 5kWh/m³ consumption for seawater [16].

International Journal of Innovative Research in Science, Engineering and Technology

(A High Impact Factor, Monthly, Peer Reviewed Journal)

Visit: www.ijirset.com

Vol. 7, Issue 9, September 2018

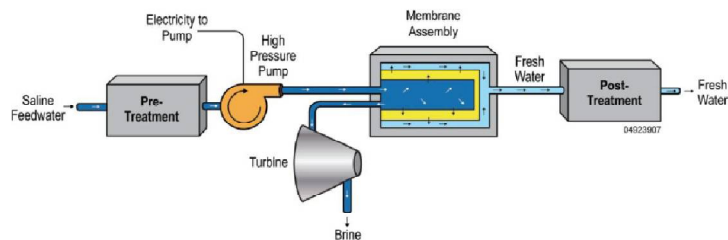

Figure 6. Principle of reverse osmosis process [12]

RO plants have low capital cost and high maintenance and running cost due to the high cost of the membrane replacement and the cost of the energy used to drive the plant. The process also requires intensive pre/post-treatment. The RO system has range from as little as 0.5m³ per day, the largest RO plant (Ashkelon Plant) is located in Israel with capacity of 330,000m³ per day which contribute 5-6% water needs. The plant cost \$212m with water cost \$0.52/m³. It occupies 75,000m³ of land, and it consists of four 5.5MW high pressure pump and 40,000 membrane modules.

Electrodialysis (ED)

Electrodialysis was commercially introduced in the early 1950s, about 10 years before RO [13]. In the 1960s, Electrodialysis Reversal (EDR) was introduced, to avoid organic fouling problems. Electrodialysis uses an electrical potential to move salts selectively through a membrane and leaving fresh water as product water. The amount of electricity required for ED and its costs increase with increasing salinity of feed water. The total energy consumption under ambient temperature conditions and assuming product water of 500 ppm TDS would be about 1.5 to 4 kWh/m³ for a feed water of 1500 to 3500 ppm TDS respectively [17]. The ED process is illustrated in figure 7. ED/EDR is not always a cost effective option for seawater desalination and does not have a barrier effect against microbiological contamination. Hence it is more suitable for brackish water and used in conjunction with conventional water treatment plants.

Like RO, ED/EDR can have capacity from 1m³ per day. The largest EDR plant is located in Abrera with a capacity of treatment of 220.000 m³ per day (576 stacks in two stages, provided by GE Water & Process) and it is related with desalting brackish water to improve the quality of the produced drinking water. The cost of the plant is €61 million with operation and maintenance cost of \$25 million over two years.

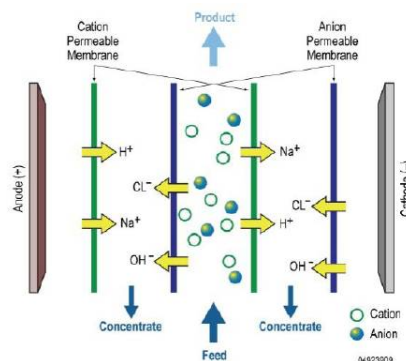

Figure 7. Ion exchange in electrodialysis process [12]

Multi-Stage Flash Distillation (MSF)

Multi-Stage flash is currently the most common technique used in thermally driven desalination. Seawater is heated and pressurised in the brine heater and then flows into chambers or stages. A fraction of it flashes into vapour due to lower pressure in the chamber and the brine passes from one stage to another and flashes repeatedly without adding

International Journal of Innovative Research in Science, Engineering and Technology

(A High Impact Factor, Monthly, Peer Reviewed Journal)

Visit: www.ijirset.com

Vol. 7, Issue 9, September 2018

more heat. The vapour produced by flashing is converted to fresh water by being condensed on tubes of heat exchangers that run through each stage. The feed water going to the heater cools the tubes and in turn gets heated, so a reduced amount of thermal energy is required in the heater. A typical MSF unit is shown in figure 8.

MSF plant can contain from 4 to about 40 stages, and usually operate at temperatures of 100 - 110 °C to produce 6-11kg of distillate per kg of steam applied [18]. Performance ratio can be as high as 12 and a 40 year life span [17]. A plant with performance ratio greater than 7 could consume thermal energy of 290kJ/kg and the electricity used to drive auxiliary components is only 4 to 6 kWh/m³. However the overall capital and energy cost are very high. The largest MSF plant is Shoaiba Desalination Plant, Saudi Arabia. It was completed in 2003 with total capacity of 450,000m³ per day at an estimated total project cost of \$1.06 billion.

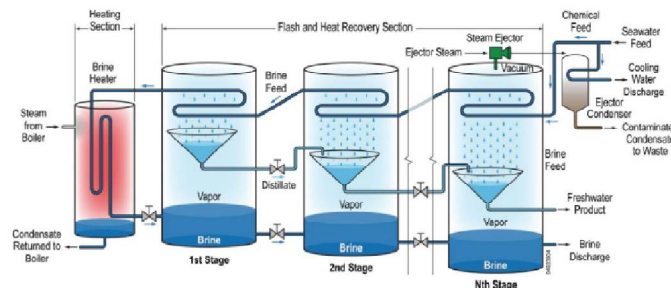

Figure 8. An illustration typical MSF plant [12]

Multiple Effect Distillation (MED)

The MED process uses same principle of evaporation and condensation at various stages known as effects. Each effect has reduced pressure than the previous effect. Hence the seawater goes through multiple boiling without the need to supplying additional heat. Preheated steam from boiler is fed into a series of tubes. It then heats the tube and act as heat exchanger to evaporate incoming seawater from another channel. The evaporated seawater becomes less salty and is fed into the next effects which are lower in pressure. The vapour condenses into fresh water. This is illustrated in figure 9.

The MED has performance ratio up to 15 for 8 to 16 effects [16]. It has maximum operating temperature of 80°C and energy consumption of 290kJ/kg and 2.5 to 3kWh/m³. The largest MED plant is to be completed by 2012 with capacity of 68,000m³ per day at the cost of \$124 million in Yanbu Saudi Arabia.

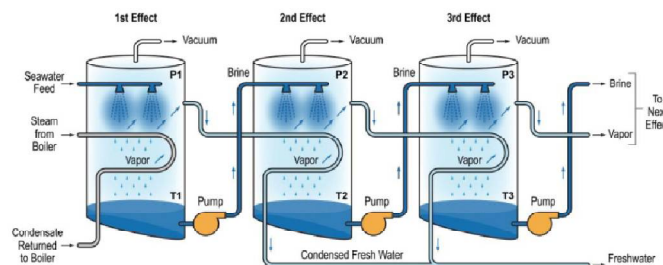

Figure 9. An illustration of MED plant [12]

V. DESALINATION AND RENEWABLE ENERGY

Due to the large energy consumption in the major commercial desalination processes, along with the growing concern about carbon emissions, there is a strong interest in desalination units driven by alternate sources of energy, and in particular, renewable energy sources (RES) such as solar, wind, geothermal and biomass energy. While majority of

International Journal of Innovative Research in Science, Engineering and Technology

(A High Impact Factor, Monthly, Peer Reviewed Journal)

Visit: www.ijirset.com

Vol. 7, Issue 9, September 2018

desalination systems driven by RES are currently under research, the current installed capacity is more than 9,000m³ per day. The distribution of installed capacity of desalination by major RES is given in figure 10.

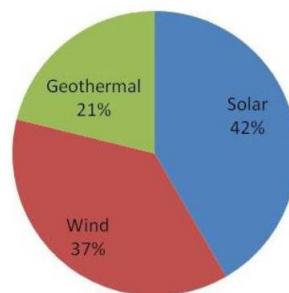

Figure 10. World distribution of desalination capacity by major RES [19]

It can be seen that solar energy dominates as renewable energy source for desalination. Regions with higher water scarcity have the most abundant solar energy. Hence the solar desalination process might be the answer for the optimum choice of water desalination. A 6kWh/m²/d of solar energy is equivalent to 0.6 litre/m²/d of oil [9]. The potential transition from conventional desalination to solar desalination would further contribute to the climate protection. In the MENA region alone, there is potential to reduce the emissions of carbon dioxide from fossil fuel from 570 million tCO₂ in 2010 to 270 million tCO₂ in 2050. This can be achieved in spite of a significant growth of population and economy expected in the region that would lead to emissions of over 1.5 billion tCO₂ following a business as usual strategy if no action is taken [20].

VI. MARKET OPPORTUNITIES

Worldwide, less 1% of drinking water is produced by desalination which is supplied by more than 14000 plants in more than 120 countries. Considering that almost one quarter of the world's population lives less than 25 km from the coast, seawater could become one of the main sources of freshwater in the near future. The market volume has soared from \$2.5 billion in 2002 to \$3.8 billion in 2005 with a growth rate of over 15% per annum (estimated value is only for plant and equipment, and not considering the whole value chain). The market worldwide is estimated to reach nearly \$30 billion with installed capacity of more than 4.38×10^{10} per year (1.2×10^8 m³ per day) by 2015. A dramatic increase is expected in new technologies and small systems applications in Asia and in particular in India and China [21]. The most attractive markets for desalinated water are within the MENA region which constitute over 50% market share. However, there are other potential regions where the price of public water is already comparatively high, and also a region where the climate is arid and regions where the population is rapidly growing. The future water demand in the MENA region was assessed by an analysis of FutureWater (Immerzeel et al. 2011), which included effects of climate change on the future availability of natural surface and groundwater resources. The analysis suggests that there will be a significant reduction of available surface and groundwater in the medium and long-term future, from 2.25×10^{11} m³ per year (6.16×10^8 m³ per day) in the year 2000 to less than 1.9×10^{11} m³ per year (5.2×10^8 m³ per day) in 2050. At the same time, water demand will grow from 2.55×10^{11} m³ per year (7×10^8 m³ per day) in the year 2000 to 4.5×10^{11} m³ per year (1.2×10^{10} m³ per day) in 2050, opening a very dangerous gap of supply that will affect the whole region from now on [20].

VIII. CONCLUSION

There is no doubt humanity is faced with growing scarcity of fresh water despite huge abundance on the planet. Demand exceeds supply with consumption only around 50% of withdrawal due to mismanagement. It will cost more to manage water resource only and not seek for alternative source. Water desalination has huge potential as a solution to

International Journal of Innovative Research in Science, Engineering and Technology

(A High Impact Factor, Monthly, Peer Reviewed Journal)

Visit: www.ijirset.com

Vol. 7, Issue 9, September 2018

global water shortage as larger population of the world live along coastlines. However, desalination technologies are energy intensive. Combining desalination with RES is promising solution.

Although the strong potential of solar thermal energy to seawater desalination is well recognized, the process is not yet developed at the commercial level. The main reason is that the existing technology, although demonstrated as technically feasible, cannot presently compete on the basis of produced water cost with conventional distillation and RO technologies. However, it is also recognized that there is still potential to improve desalination systems based on solar thermal energy.

REFERENCES

- [1] <http://ga.water.usg.gov/edu/waterdistribution.html>, Accessed 10/05/2011
- [2] FAO, Review of World Water Resources by Country, Rome 2003.
- [3] <http://enviroscope.iges.or.jp/contents/eLearning/waterdemo/factsforall.htm> <accessed 28/04/11>
- [4] Niemczynowicz, J., Present challenges in water management. Water International. 25: 139-147 (2000).
- [5] Abdul Khaleq Lazard, Development of Novel Small-Scale Desalination, London South Bank University, PhD Thesis. 2005.
- [6] International Desalination Association. Desalination for a better world, <http://www.idadesal.org/t-homevideo.aspx>. Accessed 19/12/09
- [7] Tom Gardner-Outlaw and Robert Engelman, Sustaining Water, Easing Scarcity: A Second Update, Population Action International, 1997.
- [8] Michael Krebs, Water shortage in Mexico City could echo the global water issue, 2009. <http://www.digitaljournal.com/article/279761> <accessed 05/01/2010>
- [9] Joachim Koschikowski, Water Desalination: When and Where Will it Make Sense?, Fraunhofer Institute for Solar Energy Systems ISE Freiburg, Germany, 2011
- [10] Koussai Quteishat, Desalination 2008: Where Do We Stand? Developments in Technologies: Technical and Economic, Middle East Desalination Research Centre, ADIRA WORKSHOP, Marrakech, Morocco 26-27 April, 2008
- [11] Michael Papapetrou et al., 2010. Roadmap for the Development of Desalination Powered by Renewable Energy. Fraunhofer Verlag.
- [12] Michael Schorr, Desalination, Trends and Technologies. Intech. 2011.
- [13] O.K. Buros, The ABCs of Desalinating. IDA. 2000.
- [14] O. Souilah et al., Water reuse of an industrial effluent by means of electro-deionisation Desalination 167, 49-54, (2004).
- [15] Brian P. Herton et al., Electrodeionization in Power Plant Applications, Presented at the 8th Annual Ultrapure Water Expo „94, Philadelphia, Pennsylvania, May 9-11, 1994.
- [16] El-Dessoukey, et al., 1998. Performance of compact parallel feed multiple effect evaporation. International workshop on desalination. University of Rome, Dec. 1998.
- [17] S. Loupasis, Technical analysis of existing renewable energy sources desalination schemes. Commission of the European Communities Directorate- General for Energy and Transport. 2002.
- [18] T. Pankratz, Large-scale desalination plants-A drought-proof water supply. International Desalination News, Issue 3-4, pg 3-6, 2000.
- [19] Koussai Quteishat, Desalination: Where Do We Stand? Developments in Technologies: Technical and Economic, Middle East Desalination Research Centre, Adira Workshop, Marrakech, Morocco 26-27 April, 2008
- [20] Fulya Verdier, MENA Regional Water Outlook Part II Desalination Using Renewable Energy Task 1 – Desalination Potential, Fichtner, 2011
- [21] <http://ec.europa.eu/environment/etap> (accessed 03/03/11)