

Performance Enhancement of Direct Torque Control of Induction Motor Using Fuzzy Logic Controller

C.Vignesh¹, S. Shantha sheela², R. Balachandar³

P.G Scholar, Sri Subramanya College of Engg & Tech, Palani, Tamilnadu, India^{1, 2, 3}

Abstract— In this paper, Direct Torque Control (DTC) approaches of induction motor (IM) drives has been proposed and it is extensively implemented in industrial variable speed applications. This paper presents a unique direct torque control (DTC) approach for induction motor (IM) drives fed by using a fuzzy logic controller. The intention is to develop a low-ripple high-performance induction motor (IM) drive. The presented scheme is founded on the emulation of the operation of the conservative six switch three-phase inverter. It routines the dc current to re-construct the stator currents desired to estimate the motor flux and the electromagnetic torque. This methodology has been adopted in the design of the vector selection table of the suggested DTC approach through fuzzy logic controller. The modelling and simulation results of direct torque control of induction motor have been confirmed by means of the software package MATLAB/Simulink.

Index Terms—Induction machine, Direct torque control, Fuzzy logic controller.

I. INTRODUCTION

For high power industrial applications it is desirable to use AC motor drive instead of DC drive. But due to inherent torque coupling present in AC motor, the dynamic response becomes sluggish. In order to improve the performance of AC motor, the motion control techniques are widely used. So that AC motor can provide good dynamic torque response as it is obtained from DC motor drives [1]. In recent years, an advanced control method called direct torque control has gained importance owing to its capability to produce fast torque control of induction motor.

Conventional DTC does not require any mechanical sensor or current regulator and coordinate transformation is not present, thus reducing the complexity. Fast and good dynamic performances and robustness has made DTC popular and is now used widely in all industrial applications [4]. Despite these advantages it has some

disadvantages such as, high torque ripple and slow transient response to step changes during start up. The major problem in a DTC-based motor drive is the presence of ripples in the motor-developed torque and stator flux. Generally, there are two key techniques to reduce the torque ripples. The first one is to use a multilevel inverter which will provide the more precise control of motor, torque and flux. However, the cost and complexity of the controller increase proportionally. The other method is space vector modulation. Its drawback is that the switching frequency still changes continuously.

Advantages of intelligent controllers such as fuzzy logic, neural network, neuro-fuzzy, etc., are well known as their designs do not depend on accurate mathematical model of the system and they can handle non-linearity of arbitrary intricacy. Among different intelligent algorithms, fuzzy logic is the simplest, which does not necessitate intensive mathematical analysis. For this purpose, we follow artificial intelligent techniques such as neural network, fuzzy logic. In this study, the Fuzzy Logic (FL) method, which is based on the language rules is employed to work out this non-linear issue.

The ripples can be reduced if the errors of the torque and the flux linkage and the angular region of the flux linkage are subdivided into several smaller subsections. Since the errors are divided into smaller sections different voltage vector is selected for small disparity in error so a more accurate voltage vector is selected and hence the torque and flux linkage errors are condensed. For this purpose we follow artificial intelligent techniques such as neural network, Fuzzy Logic. In this paper the Fuzzy Logic (FL) method, which is based on the language rules, is employed to solve this nonlinear issue

II. OPERATING STRATEGY OF PROPOSED SYSTEM

Direct Torque Control (DTC) is one of the proposal used in variable frequency drives to control the torque (and thus finally the speed) of three phase AC electric motors. The name direct torque control is

imitative from the fact that on the basis of the errors between the reference and the estimated values of torque and flux, it is possible to directly control the inverter states in order to shrink the torque and flux errors within the prefixed band limits. Direct torque control method was introduced in the middle of 80's by Isao Takahashi and Toshihiko Noguchi (1980). The philosophy of DTC method is to select one of the inverters namely six voltage vectors and two zero vectors in order to keep the stator flux and torque within a hysteresis band around the demand flux and torque magnitudes. The basic DTC scheme is revealed in Figure.1.

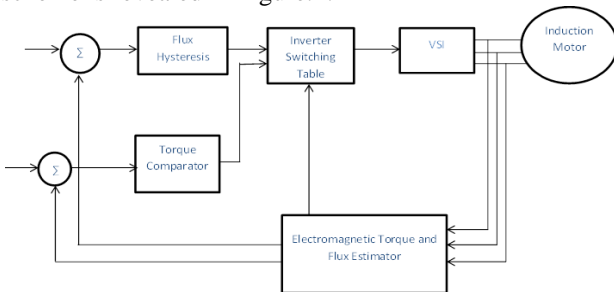

Fig.1. Block Diagram of DTC.

Direct torque control technique stator flux modulus is kept constant and its angle is changed rapidly then electromagnetic torque is directly controlled. The reference values of stator flux modulus and torque are compared to their actual values. The resulting errors are fed to the input of optimum switching table. The fundamental principle of DTC is to directly manipulate the stator flux vector such that the desired torque is produced. This is achieved by choosing an inverter switch combination that drives the stator flux vector by directly applying the appropriate voltages to the motor windings.

2.1 Basic DTC Operation

Direct torque control (DTC) is one way used in variable frequency drives to control the torque (and thus finally the speed) of three-phase AC electric motors. This involves calculating an estimate of the motor's magnetic flux and torque based on the measured voltage and current of the motor.

2.2 Operating Method

Stator flux linkage is estimated by integrating the stator voltages. Torque is estimated as a cross product of estimated stator flux linkage vector and measured motor current vector. The estimated flux magnitude and torque are then compared

with their reference values. If either the estimated flux or torque deviates from the reference more than allowed tolerance, the transistors of the variable frequency drive are turned off and on in such a way that the flux and torque errors will return in their tolerant bands as fast as possible. Thus direct torque control is one form of the hysteresis or bang-bang control.

The direct torque method performs very well even without speed sensors. However, the flux estimation is usually based on the integration of the motor phase voltages. Due to the inevitable errors in the voltage measurement and stator resistance estimate the integrals tend to become erroneous at low speed. Thus it is not possible to control the motor if the output frequency of the variable frequency drive is zero. However, by careful design of the control system it is possible to have the minimum frequency in the range 0.5 Hz to 1 Hz that is enough to make possible to start an induction motor with full torque from a standstill situation.

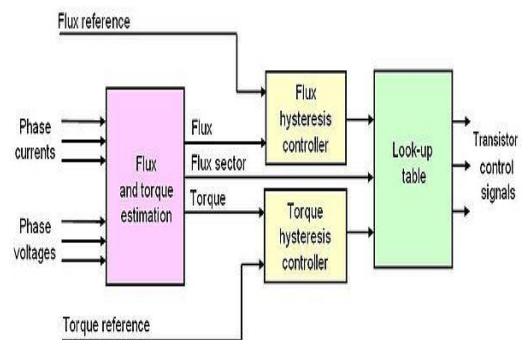

Fig.2. Control Method

2.3 Torque Ripple Minimization

In order to reducing the ripples in the output, intelligent controllers are used. Some of the intelligent controllers are fuzzy logic, neural network, neuro fuzzy etc. Advantages of intelligent controllers are well known as their designs do not depend on accurate mathematical model of the system and they can handle non linearity of arbitrary complexity. A rectifier is an electrical device that converts alternating current (AC), which periodically reverses direction, to direct current (DC), which is in only one direction, a process known as rectification. Rectifiers have many uses including as components of power supplies and as detectors of radio signals. Rectifiers may be made of solid state diodes, vacuum tube diodes, mercury arc valves, and other components.

An inverter is an electrical device that converts direct current (DC) to alternating current (AC) the

converted AC can be at any required voltage and frequency with the use of appropriate transformers, switching, and control circuits. Solid-state inverters have no moving parts and are used in a wide range of applications, from small switching power supplies in computers, to large electric utility high-voltage direct current applications that transport bulk power. Inverters are commonly used to supply AC power from DC sources such as solar panels or batteries.

2.4 CONTROL TECHNIQUES

2.4.1 Flux Hysteresis Control

This is the set of tools and conveniences that help you use MATLAB functions and files. Many of these tools are graphical user interfaces. It includes the MATLAB desktop and Command Window, a command history, and browsers for viewing help, the workspace, files, and the search path.

2.4.2 Torque Hysteresis Control

This is a enormous collection of computational algorithms ranging from elementary functions like sum, sine, cosine, and complex arithmetic, to more sophisticated functions like matrix inverse, matrix eigen values, Bessel functions, and fast Fourier transforms.

2.4.3 Logic Control

Logic control systems for industrial and commercial machinery were historically implemented at mains voltage using interconnected relays, designed using ladder logic. Today, most such systems are constructed with programmable logic controllers (PLCs) or microcontrollers. The notation of ladder logic is still in use as a programming idiom for PLCs. Logic controllers may respond to switches, light sensors, pressure switches, etc., and can cause the machinery to start and stop various operations. Logic systems are used to sequence mechanical operations in many applications. PLC software can be written in many different ways – ladder diagrams, SFC – sequential function charts or in language terms known as statement lists. Examples include elevators, washing machines and other systems with interrelated stop-go operations. Logic systems are quite easy to design, and can handle very complex operations. Some aspects of logic system design make use of Boolean logic.

2.4.4 On–Off Control

For example, a thermostat is a simple negative-feedback

control when the temperature (the "process variable" or PV) goes below a set point (SP), the heater is switched on. Another example could be a pressure switch on an air compressor: when the pressure (PV) drops below the threshold (SP), the pump is powered. Refrigerators and vacuum pumps contain similar mechanisms operating in reverse, but still providing negative feedback to correct errors. Simple on off feedback control systems like these are cheap and effective. In some cases, like the simple compressor example, they may represent a good design choice. In most applications of on off feedback control, some consideration needs to be given to other costs, such as wear and tear of control valves and maybe other start-up costs when power is reapplied each time the PV drops. Therefore, practical on off control systems are designed to include hysteresis, usually in the form of a deadband, a region around the setpoint value in which no control action occurs. The width of deadband may be adjustable or programmable.

2.5 PRINCIPLES OF FUZZY LOGIC CONTROLLER

The Fuzzy Logic system involves three steps fuzzification, application of Fuzzy rules and decision making and defuzzification. Fuzzification involves mapping input crisp values to Fuzzy variables. Fuzzy inference consists of Fuzzy rules and decision is made based on these Fuzzy rules. These Fuzzy rules are applied to the fuzzified input values and Fuzzy outputs are calculated. In the last step, a defuzzifier converts the Fuzzy outputs back to the crisp values. The Fuzzy controller in this paper is designed to have three Fuzzy input Variables and one output variable for applying the Fuzzy control to direct torque control of Induction Motor there are three variable input Fuzzy Logic variables - the stator flux error, electromagnetic torque error, and angle of flux stator.

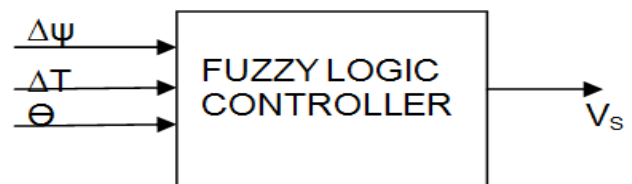

Fig.3. Block Diagram of Fuzzy logic controller.

The membership functions of these Fuzzy sets are triangular with two membership function N, P for the flux-error, three membership functions N, Z, P for the torque-error, six membership variables for the stator flux

position sector and eight membership functions for the output commanding the inverter. The inference system contains thirty six Fuzzy rules which is framed in order to reduce the torque and flux ripples. Each rule takes three inputs, and produces one output, which is a voltage vector. Each voltage vector corresponds to a switching state of the inverter. The switching state decides the pulse to be applied to the inverter. The Fuzzy inference uses Mamdani's procedure for applying Fuzzy rules which is based on min-max decision. Depending on the values of flux error, torque error and stator flux position the output voltage vector is chosen based on the Fuzzy rules. Using Fuzzy Logic controller the voltage vector is selected such that the amplitude and flux linkage angle is controlled. Since the torque depends on the flux linkage angle the torque can be controlled and hence the torque error is very much reduced.

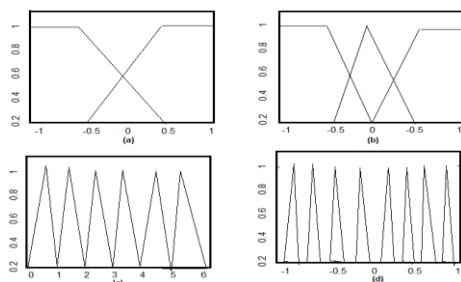

Fig 4. Fuzzy membership functions. (a) flux error, (b) torque error, (c) stator flux position sector, (d) pulses controlling the pwm inverter.

2.5.1 Fuzzy Direct Torque Controller

The fuzzy direct torque control technique consists of inverter, induction motor, torque controller, flux controller, flux estimator, torque estimator and Clarke 's transform. The Fuzzy Logic (FL) technique, which is based on the language rules, is employed to solve this nonlinear issue. In a three phase voltage source inverter, the switching commands of each inverter leg are complementary. For each leg a logic state C_i ($i=a, b, c$) is defined, that is C_i is 1 if the upper switch is turned on and lower switch is turned off. If C_i is 0 then it means that the lower switch is on and upper switch is turned off. Since there are 3 independent legs there will be eight different states, so eight different voltages.

To study the performance of the developed DTC model, a closed loop torque control of the drive is simulated using Matlab/Simulink simulation package. The torque error and flux errors are compared in their respective defined hysteresis band to generate the respective logic

states as ST and SΨ. The sector determination logic state S_0 is used as the third controlling signal for referring the DTC switching table. These three controlling signals are used to determine the instantaneous inverter switching voltage vector from three-dimensional DTC switching lookup table. The simulation results are implemented for conventional DTC scheme and proposed Fuzzy based DTC scheme. There are six non-zero voltage vectors and two zero voltage vectors.

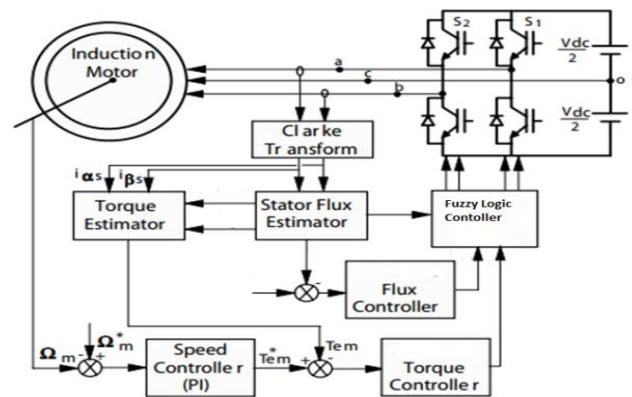

Fig 5. Block Diagram of fuzzy logic DTC.

The DTFC of induction motor drive is designed to have three fuzzy input variables and one output control variable to achieve fuzzy logic based DTC of the induction machine. Its functional block diagram is as shown in fig 6

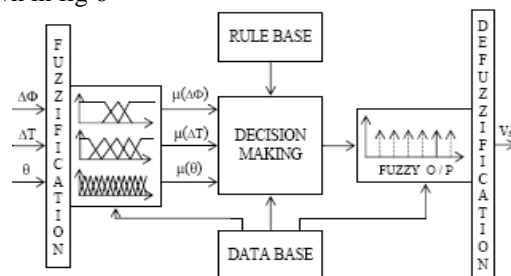

Fig.6:DTFC functional Block diagram

It necessitates three input variables, the stator flux error, electro magnetic torque error and angle of stator flux. The output is the voltage space vector. The anticipated DTFC consists of fuzzification, rule base, data base, decision making and defuzzification blocks as shown in Fig 5.4. The input variables $\Delta\Phi$, ΔT and θ are fuzzyfied using fuzzy functions over the respective domains. The output of DTFC is also fuzzyfied using fuzzy singletons. The all possible fuzzy rules are stored in fuzzy rule base.

DTFC takes the decision for the given input crisp variables by firing this rule base.

III. SIMULATION RESULTS

The simulation of the direct torque control of induction motor using fuzzy logic controller is done by using MATLAB/Simulink. The various input and output waveforms are showed below.

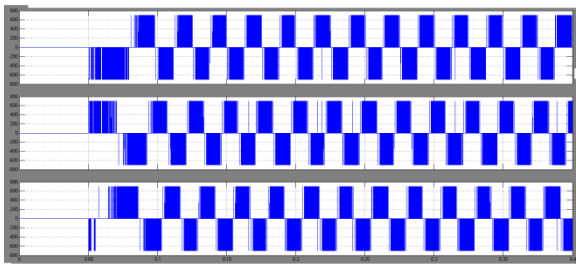

Fig.(a).Proposed stator voltage(Vas)

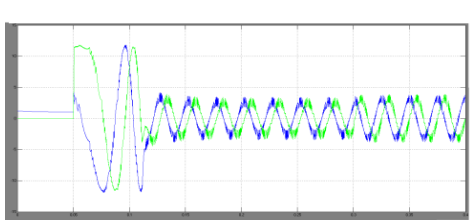

Fig.(b) .Proposed stator current

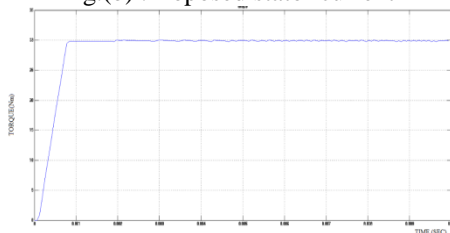

Fig.(c).Proposed torque

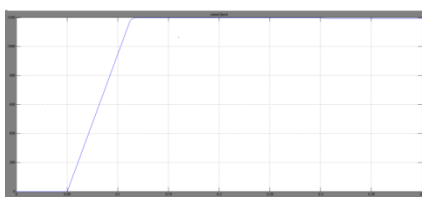

Fig.(d).Proposed speed

Hence the various output voltages are illustrated with respect to the input voltage and current. The final conclusion about the direct torque control of induction motor using fuzzy logic controller can be evidently known from above showed figures[fig: a-e].

IV. CONCLUSION

This paper deals with the direct torque control of induction motor using fuzzy logic controller .Direct torque control (DTC) is one technique used in variable frequency drives to control the torque (and thus finally the speed) of three-phase AC electric motors. This involves calculating an estimate of the motor's magnetic flux and torque based on the measured voltage and current of the motor. This sort of control allows decoupling the flux and the torque without the need for a transformation of coordinates. DTC system has a high ripples for both electromagnetic torque and stator flux and a distortion of the stator current. To solve this problem the new approach of DTC scheme making use of fuzzy logic controller. . The analysis of voltage and current waveforms are also done by using the simulation results. MATLAB/SIMULINK is used for the simulation of the proposed system.

REFERENCES

- [1] Ahmed Masmoudi,BadiiBouzidi,BassemElBads(2013) ‘ DTC Scheme for a Four Switch Inverter Fed Induction Motor Emulating the Six Switch Inverter Operation .’IEE transactions on power electronics,vol . 28, no. 7.
- [2] Hao Zhu, Xi Xiao, and Yongdong Li, (2012) ‘ Torque Ripple Reduction of the Torque Predictive control Scheme for Permanent-Magnet Synchronous Motors IEEE transactionson industrial electronics, vol. 59, no.2.
- [3] M. E. Elbuluk,N. R. B. N. Idris,A. B. Jidin,T. SutiknoA. H. B. M. Yatim,(2012) ‘A wide-speed high torque capability utilizing overmodulationstrategy in DTC of induction machines with constant switching frequency controller.’IEEE transactionspower electronics’ vol. 27, no. 5, ,May 2012.
- [4] M. Hafeez, M. N. Uddin (2012) “FLC-based DTC scheme to improve the dynamic performance of an IM drive,IEEE transactions vol. 48,no.6
- [5] Khoa D. Hoang , Z. Q. Zhu, and Martin P, Foster, (2011) ‘ Efficiency Improvement in DTC of Six Phase Induction Machine by Adaptive Gradient Descent of Flux.’ IEEE transactions on power electronics, vol 27,no.3.
- [6] M. P. Foste,r K. D. Hoang , Z. Q. Zhu(2011) ‘Influence and Compensation of Inverter Voltage Dropin Direct Torque-Controlled Four-SwitchThree-Phase PM Brushless AC Drives.’ IEEE transactions on power electronics,vol . 26, no. 8.
- [7] J. Beerten, J Driesen, Verveckken, and .(2010)‘Predictive direct torque controlfor flux and torque ripple reduction. IEEE transactions on industrial electronics vol. 57,no. 1.
- [8] B. BoadongX. DexinT. Renyuyan,Z. Zhifeng, (2010) Novel direct torque control