

# A Comparative Study of the Three Most Frequently Used PLL Techniques

Swagat Pati#1, Sarthak Chand#2, Santosh Achaya#3

#1 Department of electrical engineering, Siksha 'O' Anusandhan University, hubaneswar, Odisha, India

#2 Department of electrical engineering, Siksha 'O' Anusandhan University, hubaneswar, Odisha, India.

#3 Department of electrical engineering, Siksha 'O' Anusandhan University, hubaneswar, Odisha, India.

**ABSTRACT**— This paper represents a comparative analysis between conventional SRF-PLL, notch filter based PLL and double decoupled SRF-PLL both under balanced and unbalanced voltage conditions. Nature of phase angle, angular frequency and positive and negative sequence voltage components for different techniques are studied. It shows that conventional SRF-PLL technique gives suitable response till balanced voltage condition prevails. At the moment system became unbalanced SRF-PLL response suffer from double frequency oscillation which makes it unreliable. Then notch filter based PLL technique is analysed. Here the unbalanced condition response is improved but the system suffers from comparatively large settling time. It also suffers from overshoot and undershoot at transient period making the estimation rather critical at that point. Finally an improved SRF-PLL with decoupling network and low pass filter is described called DDSRF-PLL. This method separates out the positive and negative sequence components initially by means of decoupling network there by eliminates the double frequency vibration in the response. it also has faster convergence and smooth transient response then that of notch filter based PLL the whole simulation is done in matlab/ simulink and a comparative statement is established.

**KEYWORDS:** SRF PLL, Notch filter based PLL, DDSRF PLL, Decoupling network, Low Pass Filter

## I. INTRODUCTION

Phase locked loops play a very vital role during the control of any type of electrical system. Mostly PLLs are designed to estimate the supply frequency and phase angle of supply voltage. But the basic requirements from a PLL circuit are, they should be fast and accurate. In its

conventional structure the PLL is called as a synchronous reference frame PLL or SRF PLL. The SRF PLL has very simple construction and is fast and accurate. But the major drawback of SRF PLL is that its output is inaccurate during unbalanced voltage conditions [1,7]. So these types of PLLs are not well suited for unbalanced network conditions. Another PLL structure which is an extension to SRF PLL employs a resonant controller in combination with a PI controller for the estimation of frequency and

phase angle [8-11] is the notch filter based PLL. The notch filter based PLL is a very extensively used PLL, which works efficiently during both balanced and unbalanced supply conditions [7]. During network unbalance presence of both positive and negative sequence components introduces an oscillating quantity to the  $d_q^+$  and  $d_q^-$  component which oscillates at a frequency twice that of the supply frequency. By using notch filters having cut of frequency of  $2\omega_s$ , the oscillatory signals are filtered out and we get DC  $d_q^+$  and  $d_q^-$  quantities. But the notch filter as a second order filter makes the convergence of the phase angle value rather slower. Again a double decoupled synchronous reference frame PLL is designed in [1-6]. The DDSRF PLL incorporates a SRF PLL with a decoupling network and low pass filters [1,2]. The decoupling network decouples the  $d_q^+$  and  $d_q^-$  quantities, so they become independent of each other and do not interfere with each other during the estimation process. This method cancels the double frequency oscillation  $V_{sq+}$  automatically without controlling the control loop band width. Here the  $\theta$  value converges to its final value very fast and waveform is improved. In this paper the basic SRF PLL is designed simulated and the performance of the PLL is evaluated both under balanced and unbalanced conditions. The notch filter based PLL is designed and simulated. Again a double decoupled synchronous reference frame

## A comparative study of the three most frequently used PLL techniques.

PLL is designed and simulated both for balanced and unbalanced network conditions. Finally all the performance of the three PLLS are evaluated and compared and a comparative statement is provided at the end. The whole simulation process is done in Matlab/Simulink environment.

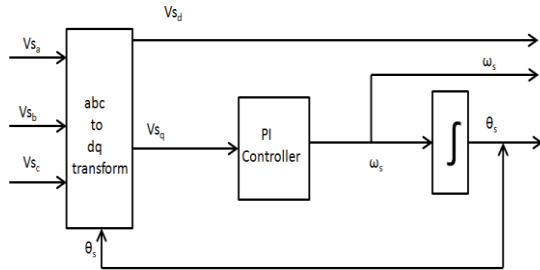

Fig.1 Block diagram of SRF PLL

Conventional SRF-PLL converts three phase voltage vector from its natural abc reference frame to synchronously rotating dq reference frame. The feedback loop controls the angular position of dq reference frame in such a manner that the q-component converge to zero. During steady state the d-component gives the amplitude of voltage vector and feedback loop output gives phase and angular frequency.

Under balanced grid condition high bandwidth SRF-PLL feedback loop gives precise and fast detection of phase and amplitude of utility voltage vector. But for distorted and unbalanced grid condition the voltage vector contains higher order harmonics. To get desired result, it is required to reduce the band width so as cancel and reject the harmonic effect.

Under balanced grid operating condition neglecting the effect of voltage harmonics, the phase voltages  $V_{si}$  where  $i \in \{a,b,c\}$  can be reproduced as follows.

$$V_{si} = V_s^{+1} \cos(\omega t - k \frac{2\pi}{3})$$

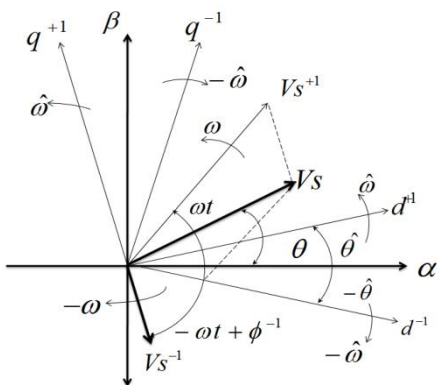

Fig.2 Phasor diagram of voltage vector.

$+V_s^{-1} \cos(-\omega t - k \frac{2\pi}{3} + \phi^{-1}) + V_s^0 \cos(\omega t + \phi^0)$   
Here superscript +1 and -1 represents the co-efficient for positive, negative sequences components,  $k=0,1,2$  for

$i=a,b,c$  respectively. According to non-normalized Clarke Transformation, the grid voltage vector is given by:

$$V_{S(\alpha\beta\gamma)} = \frac{2}{3} \begin{bmatrix} 1 & -\frac{1}{2} & -\frac{1}{2} \\ 0 & \frac{\sqrt{3}}{2} & -\frac{\sqrt{3}}{2} \\ \frac{1}{2} & \frac{1}{2} & \frac{1}{2} \end{bmatrix} \begin{bmatrix} V_{S_a} \\ V_{S_b} \\ V_{S_c} \end{bmatrix}$$

Neglecting the zero-sequence, voltage vector in  $\alpha$ - $\beta$  plane considering positive sequence voltage component as phase origin can be given as follows.

$$V_{S(\alpha\beta)} = V_s^+ \begin{bmatrix} \cos(\omega t) \\ \sin(\omega t) \end{bmatrix} + V_s^- \begin{bmatrix} \cos(-\omega t - \phi^{-1}) \\ \sin(-\omega t + \phi^{-1}) \end{bmatrix}$$

Where, sub-vector  $V_s^{+1}$  rotates with a positive angular frequency  $\omega$  and  $V_s^{-1}$  rotates with a negative angular frequency  $-\omega$ , the amplitude and angular position of voltage vector is given by above two equations. It is also clearly understood that the magnitude and rotational frequency are always variable under unbalanced grid conditions.

$$|V_s| = \sqrt{(V_s^{+1})^2 + (V_s^{-1})^2 + 2(V_s^{+1})(V_s^{-1})\cos(-2\omega t + \phi^{-1})}$$

$$\phi = \omega t + \tan^{-1} \left( \frac{V_s^{-1} \sin(-2\omega t + \phi^{-1})}{V_s^{+1} + V_s^{-1} \cos(-2\omega t + \phi^{-1})} \right)$$

$$V_{sd} \approx V_s^{+1} + V_s^{-1} \cos(-2\omega t + \phi^{-1})$$

$$\phi \approx \omega t$$

$$V_{s(dq^{+1})} = V_s^{+1} \begin{bmatrix} \cos(\omega t - \hat{\theta}) \\ \sin(\omega t - \hat{\theta}) \end{bmatrix} + V_s^{-1} \begin{bmatrix} \cos(-\omega t + \phi^{-1} - \hat{\theta}) \\ \sin(-\omega t + \phi^{-1} - \hat{\theta}) \end{bmatrix}$$

$$V_{s(dq^{-1})} = V_s^{+1} \begin{bmatrix} \cos(\omega t + \hat{\theta}) \\ \sin(\omega t + \hat{\theta}) \end{bmatrix} + V_s^{-1} \begin{bmatrix} \cos(-\omega t + \phi^{-1} + \hat{\theta}) \\ \sin(-\omega t + \phi^{-1} + \hat{\theta}) \end{bmatrix}$$

This SRF-PLL structure can be properly adjusted by adjusting its control parameters to achieve  $\hat{\theta} \approx \omega t$  by small signal analysis method. This method gives the following equations.

$$\sin(\omega t - \hat{\theta}) \approx (\omega t - \hat{\theta})$$

$$\cos(\omega t - \hat{\theta}) \approx 1 - ((\omega t - \hat{\theta})^2 / 2)$$

$$(\omega t - \hat{\theta}) \approx -2\omega t$$

Such conditions can also be linearised as given below.

$$V_{s(dq+1)} = V_s^{+1} \begin{bmatrix} (1 - (\omega t - \hat{\theta})^2 / 2) \\ \omega t - \hat{\theta} \end{bmatrix} + V_s^{-1} \begin{bmatrix} \cos(-2\omega t + \phi^{-1}) \\ \sin(-2\omega t + \phi^{-1}) \end{bmatrix}$$

$$V_{s(dq-1)} = V_s^{+1} \begin{bmatrix} \cos(2\omega t) \\ \sin(2\omega t) \end{bmatrix} + V_s^{-1} \begin{bmatrix} \cos(\phi^{-1}) \\ \sin(\phi^{-1}) \end{bmatrix}$$

The double frequency oscillations at  $2\omega$  appeared here is due to the coupling between axes appearing as a result of oppositely rotating vectors. These unwanted oscillations are considered as noise in the detection of  $V_s^{+1}$  and  $V_s^{-1}$  and should be attenuated by means of conventional filtering

## A comparative study of the three most frequently used PLL techniques.

techniques. One of such most used filtering techniques is notch filter based SRF-PLL techniques. In notch filter based SRF-PLL method a band trap filter tuned at twice the line frequency is used. This filter removes the double frequency oscillations present in the negative sequence components the schematic diagram is given as below.

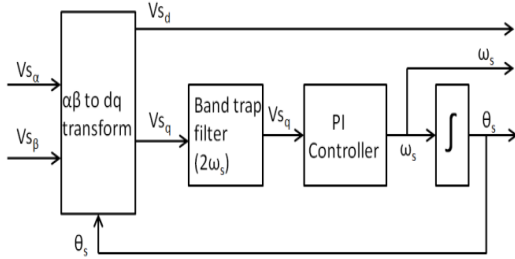

Fig.3 Block diagram of Notch filter based PLL.

This technique improves the SRF-PLL response and positive and negative sequence component waveforms are improved and also the phase angle variation became smoother than that of the SRF-PLL, during the unbalanced grid condition. But in this technique the convergence of phase angle became very slower due to the presence of second order notch filter. Also the positive sequence component suffers from slight oscillations whose effect is negligible in many cases but in critical analysis this slight oscillations can cause serious problems in the dynamic response of high performance control processes.

It has now become necessary to obtain accurate results for amplitudes of positive and negative sequence components i.e.  $V_{s^{+1}}$  and  $V_{s^{-1}}$  respectively along with improving the detection system dynamics. This requirement needs a decoupling network which separates out the  $dq^+$  and  $dq^-$  quantities so that they become independent of each other and do not interfere during estimation process.

This technique adopts an SRF-PLL along with low pass filters and a decoupling network to make it double decoupled SRF-PLL. The decoupling network assumes the voltage vector to be consisting of two generic components rotating at  $n\omega$  and  $m\omega$  frequencies respectively. Here  $n$  and  $m$  are may be positive or negative and  $\omega$  is the fundamental grid frequency. The voltage vector can be written as follows.

$$V_{s(\alpha\beta)} = \begin{bmatrix} V_{s\alpha} \\ V_{s\beta} \end{bmatrix} = V_{s^n(\alpha\beta)} + V_{s^m(\alpha\beta)} = V_{s^n} \begin{bmatrix} \cos(n\omega t + \phi^n) \\ \sin(n\omega t + \phi^n) \end{bmatrix} + V_{s^m} \begin{bmatrix} \cos(m\omega t + \phi^m) \\ \sin(m\omega t + \phi^m) \end{bmatrix}$$

Here  $dq^n$  and  $dq^m$  are two rotating reference frames having angular positions  $n\hat{\theta}$  and  $m\hat{\theta}$  respectively. Here  $\hat{\theta}$  is the detected phase angel given by the DDSRF-PLL. When  $\hat{\theta} = \omega t$ , perfect synchronization of PLL is possible. In this

case the voltage vector can be described on  $dq^n$  and  $dq^m$  reference frame.

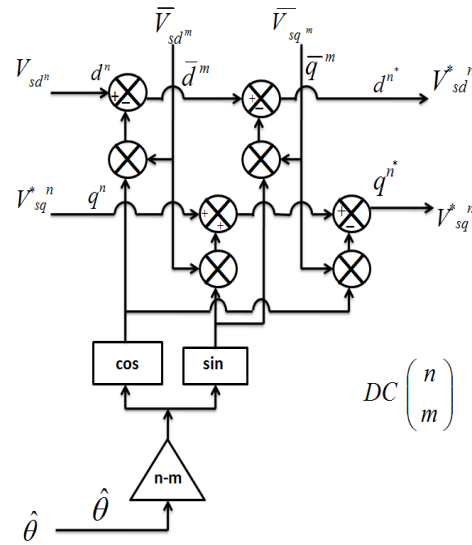

Fig.4 Block diagram of decoupling network.

$$V_{s(dq^n)} = \begin{bmatrix} V_{s_{d^n}} \\ V_{s_{q^n}} \end{bmatrix} = V_{s^n} \begin{bmatrix} \cos(\phi^n) \\ \sin(\phi^n) \end{bmatrix} + V_{s^m} \cos(\phi^m) \begin{bmatrix} \cos((n-m)\omega t) \\ -\sin((n-m)\omega t) \end{bmatrix} + V_{s^m} \sin(\phi^m) \begin{bmatrix} \sin((n-m)\omega t) \\ \cos((n-m)\omega t) \end{bmatrix}$$

$$V_{s(dq^m)} = \begin{bmatrix} V_{s_{d^m}} \\ V_{s_{q^m}} \end{bmatrix} = V_{s^m} \begin{bmatrix} \cos(\phi^m) \\ \sin(\phi^m) \end{bmatrix} + V_{s^n} \cos(\phi^n) \begin{bmatrix} \cos((n-m)\omega t) \\ \sin((n-m)\omega t) \end{bmatrix} + V_{s^n} \sin(\phi^n) \begin{bmatrix} -\sin((n-m)\omega t) \\ \cos((n-m)\omega t) \end{bmatrix}$$

The amplitude of oscillation of the signal in  $dq^n$  axes depends upon the mean value of the signal present in  $dq^m$  axes and vice versa. The proposed Fig.4 is the decoupling cell which cancels out the oscillations present in  $dq^n$  axes signal. To cancel out the oscillations present in  $dq^n$  axes signal simple interchanging of  $m$  and  $n$  can do the job.

For both the decoupling cells to act properly it is always necessary to design the determination mechanism for the values of vector  $V_{sd^n}$ ,  $V_{sq^n}$ ,  $V_{sd^m}$  and  $V_{sq^m}$ . To achieve this objective a cross feedback de coupling network is proposed in figure (5). Here in this network the LPF block is a first order low pass filter whose transfer

**A comparative study of the three most frequently used PLL techniques.**

function is given as follows.  $LPF(S) = \frac{\omega_f}{s + \omega_f}$

$\frac{\omega_f}{\omega} = k$ , and k in this work has been set to  $\frac{1}{\sqrt{2}}$ .

Fig.5 Block diagram of DDSRF PLL

After the unbalanced condition is over SRF-PLL takes 0.08 sec to attain its steady state response making conventional SRF-PLL more vulnerable to transient conditions.

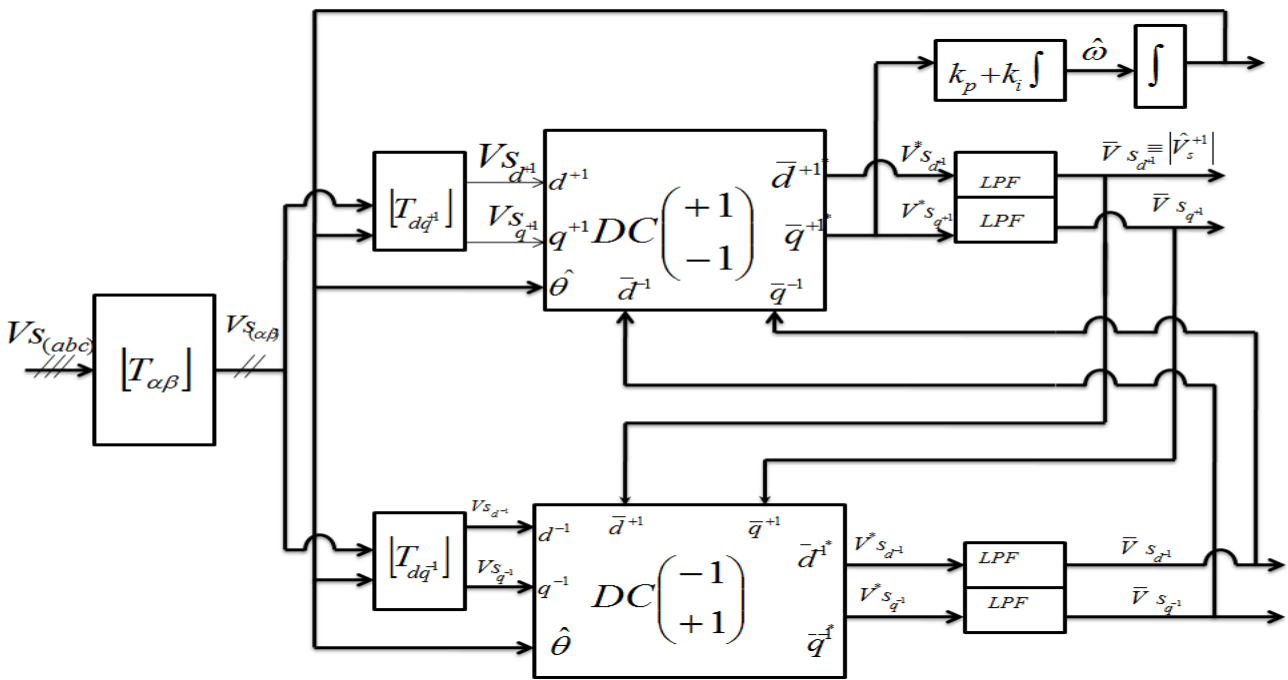

**II. SIMULATION RESULTS**

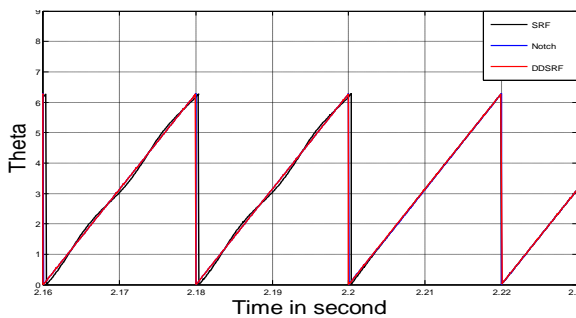

Fig.6 Response of theta ( $\theta$ ) during fault

Fig.6 shows for unbalanced condition the  $\theta$  response is unaffected in DDSRF technique but conventional SRF fails to remain in steady state and suffers from oscillations. Notch filter based PLL takes 0.03 sec. to catch the final value rendering slow operation.

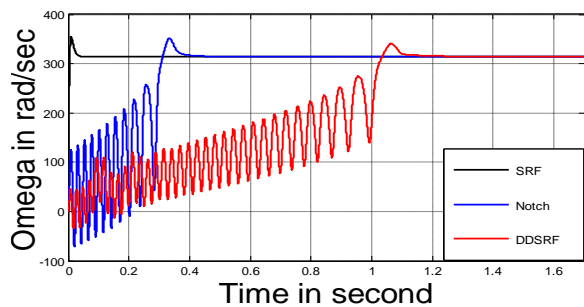

Fig.7(a)

Fig.7(a) shows angular frequency ( $\omega$ ) estimation is bit slower in case of DDSRF-PLL initially during steady

## A comparative study of the three most frequently used PLL techniques.

state. Here DDSRF-PLL takes 1.65 sec. to reach its steady state value.

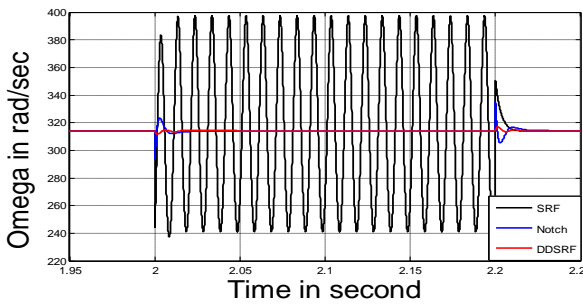

Fig.7(b)

Fig.7(b) shows during unbalanced grid condition conventional SRF-PLL suffers from undamped double frequency oscillation about a mean of 314.2 with amplitude of 84.1 rad/sec.

Notch Filter based SRF-PLL attains an 6.5% undershoot and takes time 0.06sec to settle down to steady state also at the end of unbalance condition an overshoot of 6.61% occurs and takes 0.06 sec. to settle down. But for DDSRF, only small variation occurs during transient condition at 2 and 2.2sec and settles down very fast making the DDSRF technique robust and fast.

Fig.10(a) shows the d axis component of positive sequence voltage for all the three PLLs. The d axis component of positive sequence shows that response of SRF-PLL suffers a sustained doubled frequency oscillation about the mean value during network unbalanced condition. So it fails to attain steady state, but after fault is over, it again attains steady state value very fast.

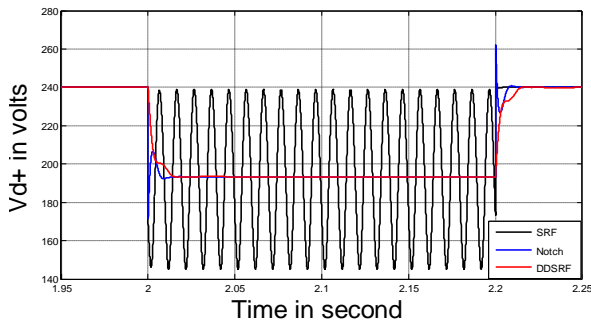

Fig.10(a)

In notch filter technique the response attains a undershoot of 12.9% at starting and a overshoot of 35.5% at the end of unbalanced condition with an pretty long delay time of 0.0215sec in both the cases. Whereas DDSRF technique response, attains the final value faster (in 0.015sec) than the rest two during unbalanced condition with zero oscillation. Here in this case also DDSRF proves to be robust and fast in operation.

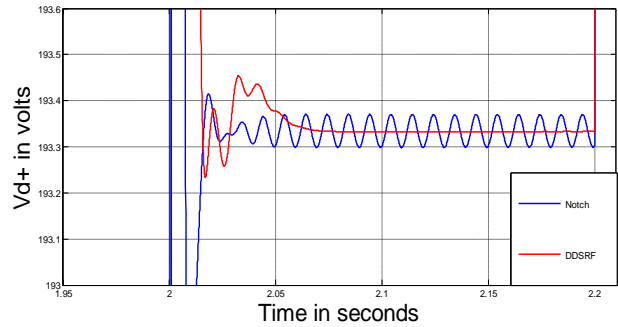

Fig.10(b)

Fig.10(b) shows the magnified version of Fig.10(a) where the response of Notch filter based PLL and DDSRF technique are only shown. It shows that notch filter response always contain a double frequency oscillation with an amplitude of 0.3 volt which is negligible. But here DDSRF PLL operates without any vibration.

The d-axis transformation of negative sequence components shows response of SRF-PLL suffers from double frequency undamped oscillation irrespective of grid condition. It attains overshoot both at starting and ending of unbalanced conditions. Notch filter response attains 63.9% undershoot at starting and 281% overshoot at end of unbalanced condition with a slower convergence (0.015 sec) to attain steady state value.

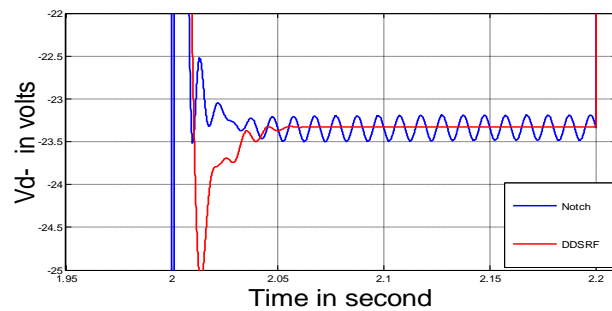

Fig.11(b)

Fig.11(b) shows the d axis component of negative sequence voltage of notch filter based and DDSRF-PLL based technique responses. It shows very negligible double frequency vibration of magnitude 0.3 volt peak to peak still present in notch filter based PLL technique response. But DDSRF response has no oscillation giving pure D.C out put both in balanced and unbalanced condition. During network transient condition it reaches the final value faster and is smoother, making DDSRF more reliable than others.

## A comparative study of the three most frequently used PLL techniques.

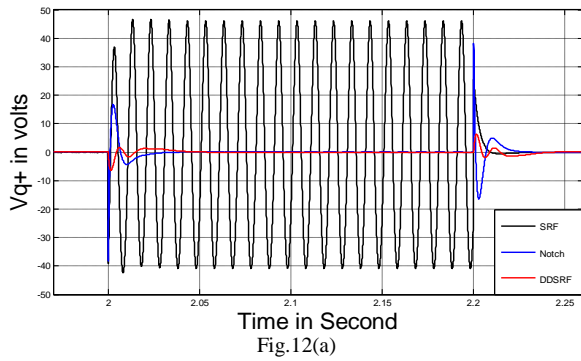

Fig.12(a)

Fig.12(a) shows the q-axis component of positive sequence voltage for all the three PLLs. The q-axis transformation of positive sequence components shows SRF-PLL technique has D.C value for balanced grid condition. During fault it suffers double frequency vibration about mean zero. But once the fault is over it settle downs to final value very fast. But notch filter based PLL attains 38% undershoot and 38% overshoot at starting and ending of fault condition respectively. It has a very long settling time of about 0.0835sec both during starting and ending of fault condition.

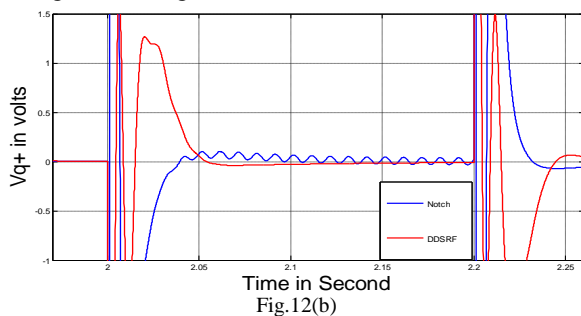

Fig.12(b)

Fig.12(b) shows in case of notch filter. Practically a very small magnitude (0.06 volt peak-to-peak) double frequency oscillation present. DDSRF technique shows the best result irrespective of fault or balanced condition except a small variation at transient periods. Zero oscillation with negligible under shoot (-6.45 V) and overshoot of (6.39 V) and very fast convergence to final value makes it more robust than other techniques.

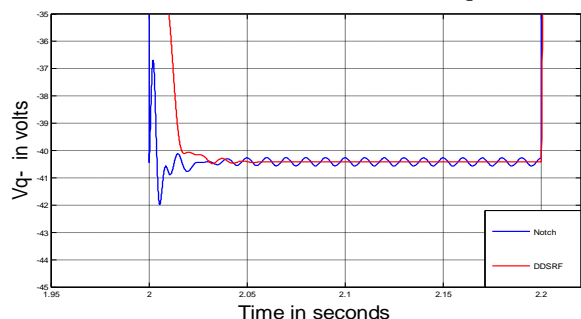

Fig.13

Fig.13 shows the q-axis component of negative sequence voltage for notch filter based PLL and DDSRF-PLL. Notch filter based PLL attains a 5.9% undershoot of at starting and 103.7% overshoot of at ending of unbalanced

condition with a settling time of 0.045sec. Here also practically the notch filter based PLL response suffers from less magnitude (0.29peak - peak) double frequency vibration.

DDSRF-PLL technique response gives the actual data here. It gives pure D.C value irrespective of network condition and track the final value very fast. It has a settling time (0.005sec).

### III.CONCLUSION

Three different PLLs namely SRF-PLL, notch filter based PLL and DDSRF-PLL have been modelled and simulated successfully. The work shows that the SRF-PLL is the fastest and most accurate PLL but gives inaccurate results during unbalanced voltage conditions. The settling time for SRF-PLL during balanced condition is ().Where as the notch filter based PLL has rather accurate results during unbalanced conditions but suffers from draw backs as low speed of convergence and small oscillations at steady state. The DDSRF-PLL has the best response during unbalanced conditions although its response is a bit slower than the SRF-PLL during balanced network condition but DDSRF-PLL is the most reliable PLL among the three.

### REFERENCES

- [1] Pedro Rodríguez, Josep Pou, Joan Bergas, J. Ignacio Candela, Rolando P. Burgos and Dushan Boroyevich, "Decoupled Double Synchronous Reference Frame PLL for Power Converters Control," *IEEE Transactions On Power Electronics*, VOL. 22, NO. 2, MARCH 2007.
- [2] Bo Sun, Ning-Yi Dai, U-Fat Chio, Man-Chung Wong, Chi-Kong Wong, Sai-Weng Sin, Seng-Pan U, R. P. Martins, "FPGA-based Decoupled Double Synchronous Reference Frame PLL for Active Power Filters," 2011 6th *IEEE Conference on Industrial Electronics and Applications*.
- [3] Pedro Rodríguez, Josep Pou, Joan Bergas, J. Ignacio Candela, Rolando P. Burgos, and Dushan Boroyevich, "Correction to "Decoupled Double Synchronous Reference Frame PLL for Power Converters Control,"" *IEEE Transactions On Power Electronics*, VOL. 22, NO. 3, MAY 2007.
- [4] Lenos Hadjidemetriou, Elias Kyriakides and Frede Blaabjerg, "A New Hybrid PLL for Interconnecting Renewable Energy Systems to the Grid." *IEEE Transactions On Industry Applications*, Vol. 49, No. 6, November/December 2013.
- [5] Gilbert Bergna, Erik Berne, Philippe Egrot, Pierre Lefranc, Amir Arzandé, Jean-Claude Vannier and Marta Molinas, "An Energy-Based Controller for HVDC Modular Multilevel Converter in Decoupled Double Synchronous Reference Frame for Voltage Oscillation Reduction," *IEEE Transactions On Industrial Electronics*, Vol. 60, No. 6, June 2013.
- [6] Manuel Reyes, Pedro Rodriguez, Sergio Vazquez, Alvaro Luna, Member, Remus Teodorescu and Juan Manuel Carrasco, "Enhanced Decoupled Double Synchronous Reference Frame Current Controller for Unbalanced Grid-Voltage Conditions," *IEEE Transactions On Power Electronics*, Vol. 27, No. 9, September 2012.
- [7] Lie Xu and Yi Wang, "Dynamic Modeling and Control of DFIG-Based Wind Turbines Under Unbalanced Network Conditions," *IEEE Transactions On Power Systems*, Vol. 22, No. 1, February 2007.

## A comparative study of the three most frequently used PLL techniques.

- [8] Oriol Gomis-Bellmunt, Adrià Junyent-Ferré, Andreas Sumper and Joan Bergas-Jané, "Ride-Through Control of a Doubly Fed Induction Generator Under Unbalanced Voltage Sags," *IEEE Transactions On Energy Conversion*, Vol. 23, No. 4, December 2008.
- [9] Peng Zhou, Yikang He and Dan Sun, "Improved Direct Power Control of a DFIG-Based Wind Turbine During Network Unbalance," *IEEE Transactions On Power Electronics*, Vol. 24, No. 11, November 2009.
- [10] Lei Shang and Jiabing Hu, "Sliding-Mode-Based Direct Power Control of Grid-Connected Wind-Turbine-Driven Doubly Fed Induction Generators Under Unbalanced Grid Voltage Conditions," *IEEE Transactions On Energy Conversion*, Vol. 27, No. 2, June 2012.
- [11] Heng Nian, Yipeng Song, Peng Zhou and Yikang He, "Improved Direct Power Control of a Wind Turbine Driven Doubly Fed Induction Generator During Transient Grid Voltage Unbalance," *IEEE Transactions On Energy Conversion*, Vol. 26, No. 3, September