

Robust Crone Control for Quadrotor type UAV's

Geetanjali Pal¹, Shimi Sudha Letha²P.G. Student, Department of Electrical Engineering, NITTTTR, Chandigarh, India¹Assistant Professor, Department of Electrical Engineering, NITTTTR, Chandigarh, India²

ABSTRACT: In this study, a robust CRONE controller is developed and implemented to improve the flight control performance and robustness of a Quadrotor type unmanned aerial vehicle(UAV). The decoupled roll-channel control is realized under certain condition and tested using the designed controller in this study. The inner closed-loop system of the roll-channel is realized using mathematical equations. For comparison purpose, a Fractional PID controller is designed and tuned, based on this identified roll-channel control model. Further a classical PID controller is also designed taking into consideration a single motor. These three designed controller share the same gain crossover frequency and gain margin settings for fair comparison. From simulation experiments, the CRONE outperforms the classical PID and designed Fractional-order PID controller.

KEYWORDS: Fractional Order Proportional-Integral- derivative(FOPID),Proportional-Integral-Derivative(PID) Unmanned Aerial Vehicle(UAS) Unmanned Aircraft System.

I. INTRODUCTION

Fractional calculus was developed as pure theoretical discipline, however its practical applications are being studied only for a couple of decades and include diffusion, electrochemistry, hereditary mechanics and control theory. Motivation on using the fractional-order controllers is that PID controllers belong to the dominating industrial controllers and therefore there is a continuous effort to improve their quality and robustness. One of the possibilities to improve PID controllers is to use fractional-order PID controllers with non-integer differentiation and integration parts.

Feedback control system is one of the major areas where the concept of fractional calculus is being applied to obtain an efficient system and also longevity and freedom. To the control engineer to compensate any shifts in the transfer function due to parametric spreads, aging etc. a system is efficient if the controller is of the similar order to that of a plant being controlled. In reality the systems are of fractional order and therefore to have a fractional order controller will be efficient.

The time domain representation of a fractional order system is given as:

$$a_n D^{\alpha n} y(t) + a_{n-1} D^{\alpha n-1} y(t) + \dots + a_0 D^{\alpha 0} y(t) = b_m D^{\beta m} u(t) + b_{m-1} D^{\beta m-1} u(t) + \dots + b_0 D^{\beta 0} u(t) \quad (1.1)$$

The transfer function of the system is:

$$G(s) = \frac{b_m s^{\beta m} + b_{m-1} s^{\beta m-1} + \dots + b_0 s^{\beta 0}}{a_n s^{\alpha n} + a_{n-1} s^{\alpha n-1} + \dots + a_0 s^{\alpha 0}} \quad (n \geq m) \quad (1.2)$$

Where, β_k ($k = 0, 1, \dots, m$), α_k ($k = 0, 1, \dots, n$) are arbitrary real numbers.

a_k ($k = 0, 1, \dots, n$) and b_k ($k = 0, 1, \dots, m$) are arbitrary constant.

International Journal of Innovative Research in Science, Engineering and Technology

(An ISO 3297: 2007 Certified Organization)

Vol. 4, Issue 8, August 2015

The feedback control loop of a fractional order system with a fractional controller is similar to the integer order feedback control loop. It is shown in fig.1.1

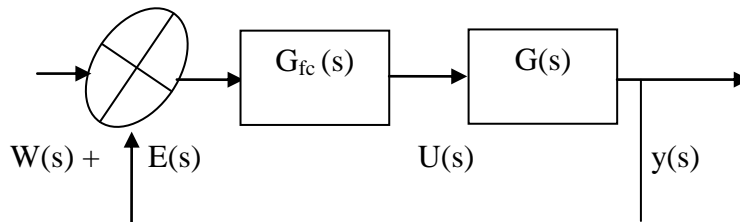

Fig.1.1 Feedback Control Loop for a Fractional system

Where,

- W(s) – Input Signal
- E(s) – Error Signal
- $G_{fc}(s)$ – Controller Transfer Function
- G(s) – System or plant Transfer Function
- Y(s) – output Signal
- U(s) – Controller Signal

II. CRONE CONTROLLER

In the automatic control field, the robustness is the ability of a control system to ensure an utmost constant closed loop characteristic, and more particularly to ensure small variation of the closed loop system stability-degree. Although the controlled plant is perturbed and its model is uncertain . CRONE is a French acronym which means: fractional order robust control.

The CRONE Toolbox, developed since the nineties by the CRONE team, is a MATLAB Toolbox dedicated to fractional calculus. In the frequency domain, they enable to synthesize simply and methodologically, linear robust control laws. The control schematic used is based on the classic unity-feedback configuration. SISO Crone control-system design is a frequency-domain approach for the robust control of uncertain (or perturbed) plants under the common unity-feedback configuration (Fig 1.2). The controller or open-loop transfer function is defined using integro-differentiation with non-integer (or fractional) order. The required robustness is that of both stability margins and performance, and particularly the robustness of the peak value (called resonant peak) of the complementary sensitivity function.

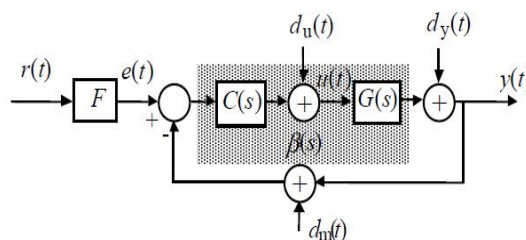

Fig 1.2 Control Diagram for CRONE

International Journal of Innovative Research in Science, Engineering and Technology

(An ISO 3297: 2007 Certified Organization)

Vol. 4, Issue 8, August 2015

The major advantage over the H_∞ designs is that the plant uncertainties (or perturbations) are taken into account without distinction of their nature, whether they be structured or unstructured. Using frequency uncertainty domains, as in the Quantitative Feedback Theory(QFT) approach where they are called template, the uncertainties are taken into account in a fully structured form without overestimation, thus leading to control laws which are as little conservative as possible. The integro-differentiation fractional order, which is either real or complex depending on the generation of the control design, permits parameterization of the open-loop transfer function with a small number of high-level parameters. The optimization of the control is thus reduced to only the search for the optimal values of these parameters. As the form of uncertainties taken into account is structured, this optimization is necessarily nonlinear. It is thus very important to limit the number of parameters to be optimized. After this optimization, the corresponding Crone controller is synthesized as a rational fraction only for the optimal open-loop transfer function. Unlike QFT, Crone control avoids iterative nonlinear optimization of each parameter of the controller's rational transfer function. Three Crone control design methods have been developed, successively extending the application field:-

- 1stfor gain-like plant perturbation model and for constant plant phase around ω_{cg} (real fractional diff. order for controller definition)
- 2ndfor gain-like plant perturbation model (real fractional diff. Order for open-loop definition)
- 3rdfor most general perturbation model (complex fractional diff. order(s) for open-loop definition)

III. CONTROLLER DESIGN AND SIMULATION

The quadrotor system is a six degrees of freedom system defined with twelve states. Six out of twelve states govern the attitude of the system . These include the angles (ϕ, θ, ψ) and angular rates(p, q, r) around the three orthogonal body axes. The other six states are the three position and three linear velocities of the center of mass of the quadrotor with respect to a fixed reference frame (earth fixed frame).

The governing state equations are non-linear. These equations have to be linearized about the stable hovering conditions. Linearization's of the nonlinear state equations are done by using jacobians of the nonlinear state equations with respect to the states and inputs around hovering condition $x_0 = [0 \ 0 \ 0 \ 0 \ 0 \ 0.1]$.

Given a set of state equations $y = f(x)$ in n equations in n state variables x_1, \dots, \dots, x_n ,

The jacobian matrix of state equations can be calculated as

$$\frac{\partial f}{\partial x} = \begin{bmatrix} \frac{\partial f_1}{\partial x_1} & \frac{\partial f_1}{\partial x_2} & \dots \\ \frac{\partial f_2}{\partial x_1} & \frac{\partial f_2}{\partial x_2} & \dots \\ \vdots & \vdots & \ddots \end{bmatrix}$$

With the mentioned non linear state equations the state space matrices A, B, C, D of the UAV system are obtained substituting respective states and inputs. Hence, state space representation is converted to transfer representation using matlab command. "ss2tf" converts a state-space representation of a given system to an equivalent transfer function representation.

$[b, a] = \text{ss2tf}(A, B, C, D, iu)$ returns the transfer function

$$H(s) = \frac{B(s)}{A(s)} = C(sI - A)^{-1}B + D$$

$$x = Ax + Bu$$

$$y = Cx + Du$$

International Journal of Innovative Research in Science, Engineering and Technology

(An ISO 3297: 2007 Certified Organization)

Vol. 4, Issue 8, August 2015

Vector *a* contains the coefficients of the denominator in descending powers of *s*. The numerator coefficients are returned in array *b* with as many rows as there are outputs *y*. Hence transfer function for roll angle, yaw angle and pitch angle is computed for a single motor. Hence PID, FOPID and CRONE control for yaw angle is computed. The SIMULINK diagram is shown below:-

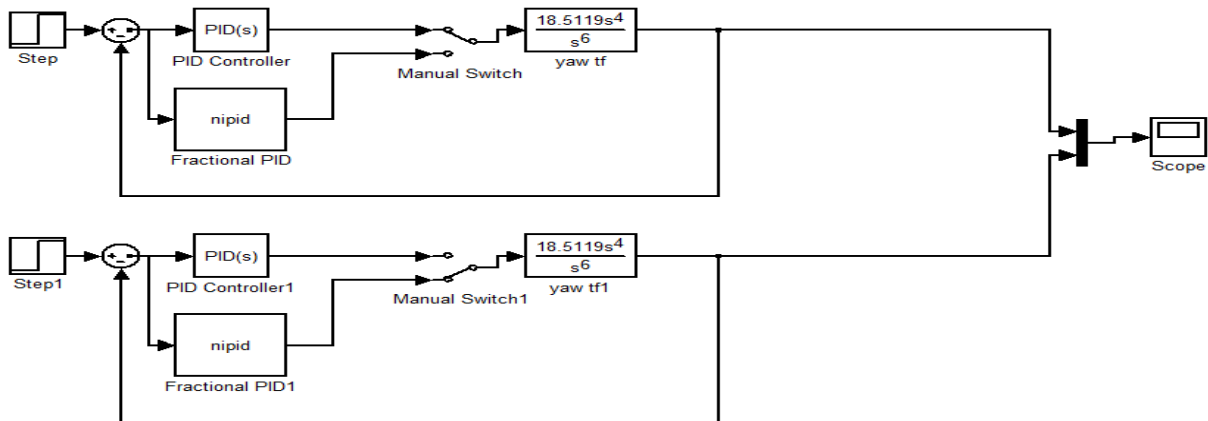

A. PID

PID stands for proportional-integral-derivative controller. Output of this controller is a control variable which is a function of its input variable i.e. an error signal. Transfer Function of the PID controller is given by:

$$\frac{U(s)}{E(s)} = \frac{K_d s^2 + K_p s + K_i}{s}$$

where, K_p is proportional gain, K_i is integral gain, and K_d is derivative gain. A PID controller is designed for the integer order model of UAV using MATLAB PID tuner block[8]. The system (Fig. 3.2 & 3.3) is tuned for the following parameters for the PID controller:

$$K_p = 0.00495520993305768$$

$$K_i = 3.91435052551545e-005$$

$$K_d = 0.0572096512468946$$

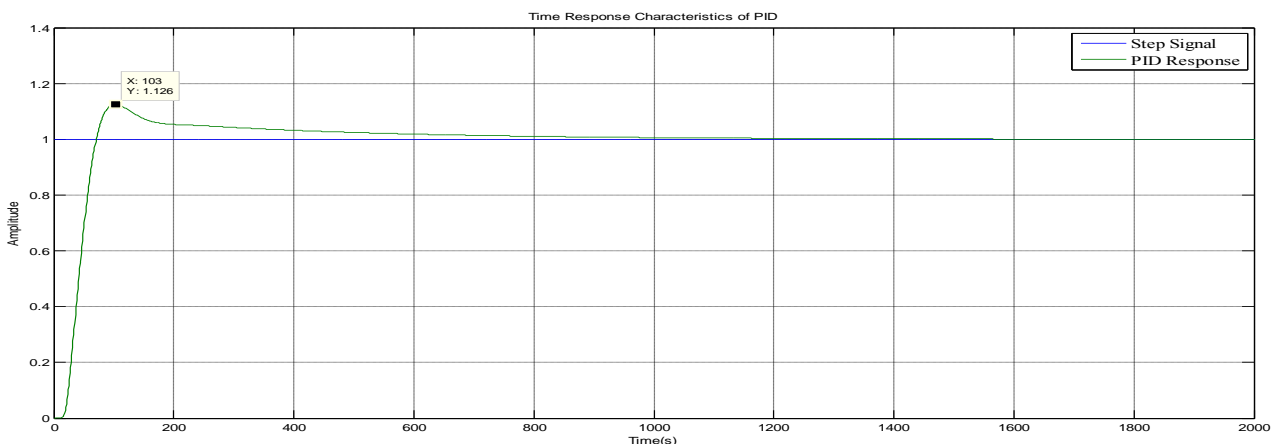

Fig 1.2 Time response of PID Controller for Yaw Angle

International Journal of Innovative Research in Science, Engineering and Technology

(An ISO 3297: 2007 Certified Organization)

Vol. 4, Issue 8, August 2015

PID controller works well for the system with fixed parameters. However, in the presence of large parameter variations or major external disturbances, the PID controllers usually face trade-off between:

- I. Fast response with significant overshoot.
- II. Smooth but slow response.

UAV control system is a highly complex, non-linear and uncertain system. For such systems a controller with more number of tuning parameters and which works well for the complex non-linear systems is to be used. Fractional PID controller and CRONE are such controller which are to be designed for the UAV control.

B. Design of Fractional PID Controller

To design a fractional controller, there are two approaches possible. The first one is placements of pole and second is by experimental results. The method of experimental results is used for design of controllers. The method involves studying the closed loop response of system by varying a tuning parameter[13]. An appropriate value of tuning parameter is

chosen depending on the closed loop performance requirements of the system i.e. overshoot, settling time, rise time, etc[15].

Fractional PID controller design involves following steps:

1. Determination of proportional gain K_p

The value of proportional gain K_p is adjusted to get minimum steady state error possible. With increase in K_p , the system leads to instability. A value of K_p is chosen as

$$K_p = 0.0$$

2. Determination of K_i and λ

When integral time T_i is increased keeping $K_p = 0.0$, it is observed that the controlled response become more and more oscillatory in nature.

Now K_i is kept constant at 0.003 and integral order λ is changed. The peak value and oscillatory nature of the response increases with increasing value of λ . The integral order λ is chosen so as to have less oscillations in the controlled response, less settling time and K_i is selected to have low possible peak value.

The values chosen are:

$$\lambda = -0.9, K_i = 0.003$$

3. Determination of K_d and δ

The increase in derivative time K_d causes the initial response to set point change becomes faster and also the peak value decreases. The value of derivative order δ is varied, which affects the peak value and also speed of the response. δ is chosen to have faster response but to avoid any peak overshoot.

The values chosen for the derivative gain and derivative order are:

$$K_d = 0.8, \delta = 0.999$$

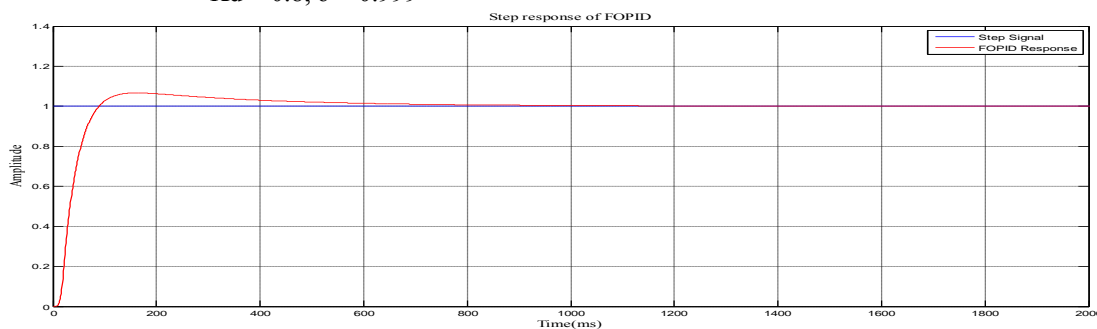

Fig 1.3 Time Response of FOPID Controller for Yaw Angle

International Journal of Innovative Research in Science, Engineering and Technology

(An ISO 3297: 2007 Certified Organization)

Vol. 4, Issue 8, August 2015

C. Crone controller

CRONE controller can be designed with 1 of the 3 units of the CRONE Control-System design toolbox.

CRONE designing is GUI based. Following steps are followed to design the controller[17]:-

Step1 Controller Implementation:-**Controller implementation way** command allows the definition of how will be implemented the controller. The field "**Controller implementation way**" can be digital or analog depending on the type of system.

Step2 Plant Definition :- The **Online definition** command allows to set the numerical variables describing the uncertain plant to be controlled.

Step 3 We select the generation of CRONE. In this case generation1 is used. Rest all the fields are automatically filled.

Step4 Hence the time response to a step function is analysed.

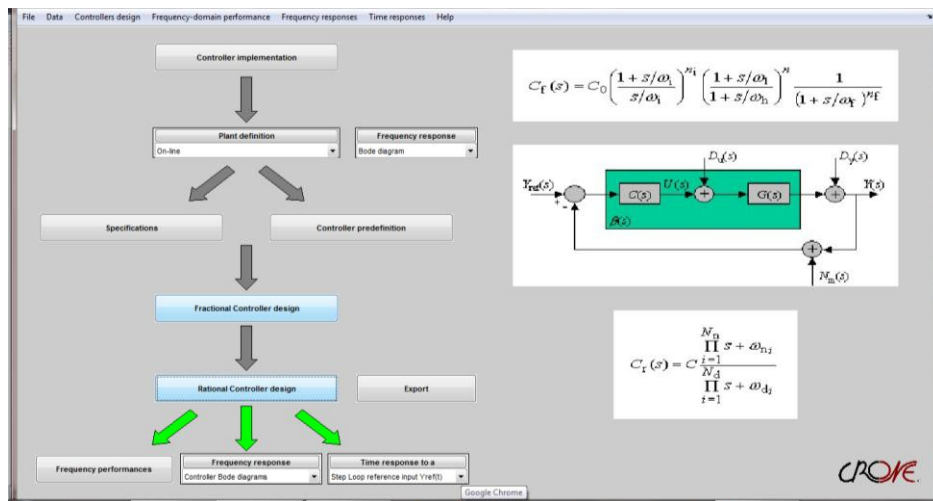

Fig 1.4 GUI for CRONE 1ST GENERATION Controller

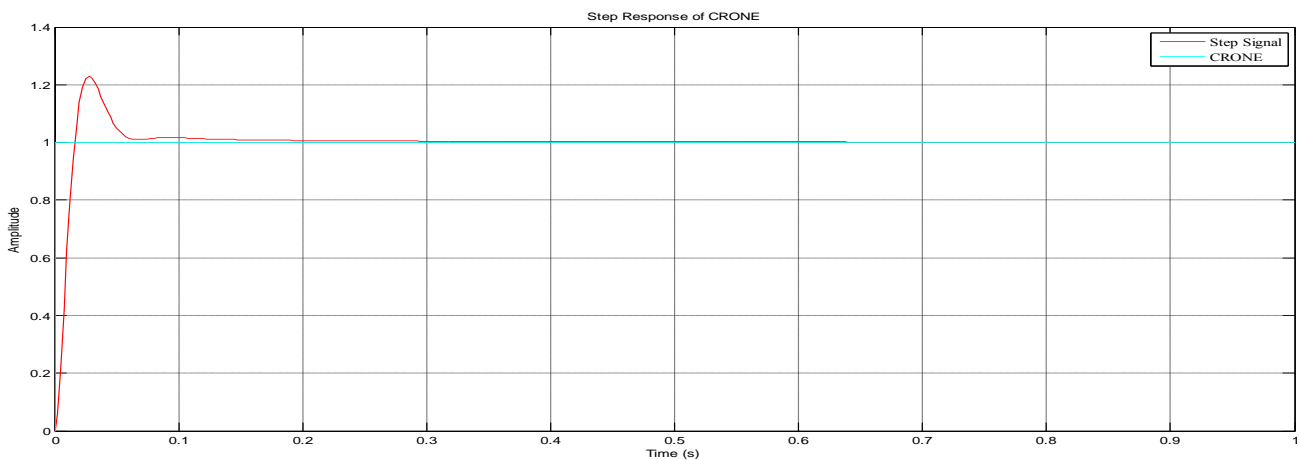

Fig. 4.8 Time Response of CRONE Controller for Yaw Angle

International Journal of Innovative Research in Science, Engineering and Technology

(An ISO 3297: 2007 Certified Organization)

Vol. 4, Issue 8, August 2015

Table 1 Comparative of time response characteristic

Specifications	PID	FOPID	CRONE
Overshoot	1.126	0.05	1.25
Rise time	2sec	1.5sec	0.1sec
Settling time	2min	1.7min	3sec
Steady state value	1	1	1

III. CONCLUSION

In present work, performance comparison of PID controller with that of fractional order PID controller is presented. Firstly, a simulation model of Unmanned Ariel Vehicle is constructed with the help of MatLab/Simulink module. Then, performance comparison of PID controller with that of fractional order PID controller are simulated and studied. The time response characteristics of both the systems for PID and fractional order PID controller are demonstrated. The effectiveness of the fractional order PID controller, CRONE and PID controller is evaluated in terms of:

- i. Rise-time
- ii. Settling-time
- iii. Overshoot

Comparing the step responses with the ones obtained (in simulation) with the PID controller, the better performance of the system with the CRONE and fractional order PID controller was observed.

Fractional order PID controller and CRONE for integer order plants offer better flexibility in adjusting gain and phase characteristics than the PID controllers, owing to the two extra tuning parameters i.e. order of integration and order of derivative in addition to proportional gain, integral time and derivative time. The key point is that fractional order controller achieves similar robustness which is achievable with very high order integer order controller. The fractional order controller is applied to a model with disturbance. Even in that case, the fractional $PI^{\delta}D^{\delta}$ controller and CRONE showed good control behavior.

Though fine-tuned FOPID controller presents smaller overshoot but CRONE outstands with its smaller settling time than conventional PID and FOPID controller.

REFERENCES

- [1] HaiYang Chao, YongCan Cao, and YangQuan Chen, "Autopilots for Small Unmanned Aerial Vehicles: A Survey", International Journal of Control, Automation and Systems, Vol 8, No.1, pp. 36-44 , 2010.
- [2] Mehmet Önder Efe " Neural Network Assisted Computationally Simple PID Control of a Quad-rotor UAV", IEEE Transaction on Industrial Informatics , VOL. 7, NO. 2, pages:- 354-361 , 2011.
- [3] Y. Luo, H. Chao, L. Di, Y.Q. Chen, "Lateral directional fractional order (PI) A Control of a Small Fixed-Wing Unmanned Aerial Vehicles: Controller Designs and Flight Tests" Journal of IET Control Theory and Applications, Vol. 5, pages:-. 2156–2167, 2011
- [4] Theerasak Sangyam, Pined Laohapiengsak, Wonlop Chongcharoen, "Autonomous Path Tracking and Disturbance Force Rejection of UAV Using Fuzzy Based Auto-Tuning PID Controller" ECTI-CON International Conference, Vol.1, pages:- 528-531 ,2010.
- [5] Lucio R. Ribeiro and Neusa Maria F. Oliveira, " UAV Autopilot Controllers Test Platform Using MATLAB/SIMULINK and X-Plane", 40th ASEE/IEEE Frontiers in Education Conference, Session s2H, pages:-S2H1-S2H5 , October 2010.

International Journal of Innovative Research in Science, Engineering and Technology

(An ISO 3297: 2007 Certified Organization)

Vol. 4, Issue 8, August 2015

- [6] Chenggong Huang¹, Qiongling Shao, Pengfei Jin, Zhen Zhu, Bihui Zhang “Pitch Attitude Controller Design and Simulation for a Small UAV International Conference on Intelligent Human-Machine Systems and Cybernetics”, International Conference on Intelligent Human-Machine Systems and Cybernetics, IEEE computer society, pages:-58-61, 2009.
- [7] Michael David Schmidt, “Simulation and Control of Quad-rotor Unmanned Aerial Vehicle” Masters Theses, Paper 93, 2011.
- [8] Atheer L. Salih, M. Moghavvemi, Haider A.F. Mohamed and Khalaf Sallom Gaeid, “Flight PID controller design for a UAV quadrotor”, Academic Journals, Scientific Research and Essays Vol. 5(23), pages:- 3660-3667, December, 2010.
- [9] Manohar B. Srikanth, Zachary T. Dydek, Anuradha M. Annaswamy and Eugene, “A Robust Environment for Simulation and Testing of Adaptive Control for Mini-UAV’s” American Control Conference, pages:-5398-5403, June 2009.
- [10] Roman Czyba, “Design of Attitude Control System for an UAV Based on Dynamic Contraction Method”, IEEE/ASME International Conference on Advanced Intelligent Mechatronics, pages:-644-649, July 2009.
- [11] Bora Erginer and Erdiç Altuğ, “Modeling and PD Control of a Quadrotor VTOL Vehicle”, Proceedings of the IEEE Intelligent Vehicles Symposium, pages:-894-899, 2007.
- [12] S. Bouabdallah, A. Noth, “PID vs LQ control techniques applied to an indoor micro quadrotor, (IEEE) International Conference on Intelligent Robots (IROS’04), (Sendai, Japan), Vol. 3, 2004.
- [13] S. Bouabdallah, P. Murrieri, and R. Siegwart, “Design and control of an indoor micro quadrotor”, In Robotics and Automation, Proceedings, ICRA, IEEE International Conference, Vol 5, 2004.
- [14] Pei-zhi Liu, Zhi-qiang Bai and Jin-hua Wang, “Robust controller design of small-scale unmanned Helicopter”, International journal of Modelling, Identification and Control, Vol. 12, pages:-17-21, 2011.
- [15] Adam Loverro, Lecture: “Fractional Calculus: History, Definitions and Applications for the Engineer, University of Notre Dame, Notre Dame, IN 46556, U.S.A., May 8, 2004.
- [16] Vineet Shekher, Kumar Dhiraj and Neel Kamal Saini, “Comprehensive Study of Fractional Controller”, VSRD-International Journal of Electrical, Electronics and Communication Engineering, Vol. 1, 2011.
- [18] Dingyu Xu et al. and YangQuan Chen, A Comparative Introduction of Four Fractional Order Controllers, Proceedings of the 4 World Congress on Intelligent Control and Automation-June 10-14, 2002.