

An Evaluation of “Dense Wavelength Division Multiplexing (DWDM) system” with and without using the “soliton pulses”

Shalini Kapoor¹, Satyendra Srivastav², Munendra Kumar Das³

P.G. Student, Department of Electronics and Communication Engineering, Shobhit University, Meerut, India¹

Associate Professor, Department of Electronics and Communication Engineering, Shobhit University, Meerut, India²

Assistant Professor, Department of Electrical Engineering, Dr. K N Modi Institute of Engineering and Technology, Meerut, India³

ABSTRACT: In the era of telecommunication industry, fiber optic communication plays an important role and we also say that the fiber optics communication is the backbone of telecommunication industry. With the development of optical networks and the use of Wavelength Division Multiplexing (WDM) technology, a new and a very crucial milestone is being reached in network evolution. To upgrade the system to handle voice and data traffic is very expensive and hence the need for the development of an intelligent all-optical network. Such a network will bring intelligence and scalability to the optical domain. DWDM (Dense Wavelength Division Multiplexing) is a technology in fiber optic communication which carries the multiple wavelengths into a single fiber to communicate to the end users with specific wavelength. When multiple wavelength transmitting over a single optical fiber these wavelength suffer cross talk due to low frequency spacing and the cross talk of wavelength affects the BER(Bit error Rate) at the receiver which determines the performance of the system. Quality factor is also a key component in the optical fiber to analyze the system performance of the of the DWDM system. As it is known fact that as the number of user increases system performance decreases. So there are three windows at which attenuation is minimum but here the author has done the research on two wavelengths, 1310nm and 1550nm. The effect of increasing length of the fiber and increasing data rates has been analyzed in the research and according to that the concept of Soliton pulses has been clubbed together so as to make the new effective system which can support higher data rate. The author has simulated and analysed different scenario, which includes the data rates at 320Gbps, 400 Gbps, 560 Gbps at different lengths of 40 km, 50km, and 80km. So the system has been designed and simulated on the optical software which is supporting 640 Gbps for 70km length.

KEYWORDS: DWDM, Soliton pulses, Quality Factor, BER.

I. INTRODUCTION

WDM assigns incoming optical signals to specific frequencies of light (wavelengths) within a certain frequency band. This multiplexing closely resembles the way radio stations broadcast on different wavelengths without interfering with each other. Because each channel is transmitted at a different frequency, we can select from them using a tuner. Another way to think about WDM is that each channel is a different colour of light; several channels then make up a rainbow.

International Journal of Innovative Research in Science, Engineering and Technology

(An ISO 3297: 2007 Certified Organization)

Vol. 4, Issue 8, August 2015

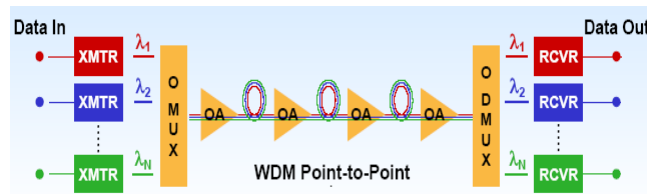

Figure 1: Wavelength Division Multiplexing

Dense Wavelength Division Multiplexing (DWDM) is that multiple wavelengths carry different optical signals on a single optical fiber.

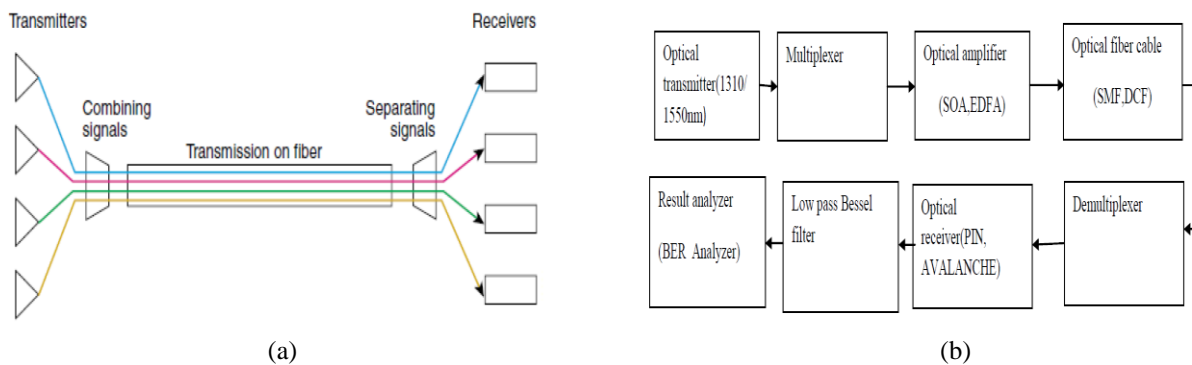

Figure 2: (a) DWDM functional schematic (b) Basic model of proposed work

In optical fiber communication different type of non linearities occurs like dispersion, attenuation, ISI, four waves mixing and many more phenomenons comes into picture when the number of users is increased. Second problem comes into account when the length of the optical fiber is increased, when the length of the fiber is increased, then also different types of non linearity came into existence and reduces the performance of the system. To reduce different type of non linearity (dispersion, scattering, attenuation) which occurs in the optical networks, we should find out the optical pulses whose shape will be constant for long distance. Soliton pulses can be the solution for this problem. Soliton pulses are the narrow width pulses.

Soliton pulses can be modelled as: $u(z, t) = \text{sech}(t) \exp(iz/2)$, where $\text{sech}(t)$ is hyperbolic secant function. Since the phase term $\exp(iz/2)$ has no influence on the shape of the pulse, the soliton is independent of z and hence is non dispersive in time domain. This property of a fundamental soliton that makes it an ideal candidate for optical communications.

II. PARAMETERS STUDIED

The following parameters were studied to compare the results obtained to study DWDM system:

1).Quality Factor: Quality factor, which is dimensionless parameter, is the ratio of the energy stored in the oscillating resonator to the energy dissipated per cycle by damping processes. The Q-factor represents the optical signal-to-noise ratio for a binary optical communication system.

2).Bit Error Rate: The bit error rate (also BER) is the number of bit errors per unit time. BER is a unit less performance measure.

III. SIMULATION SCENARIO

In our work, we have done the analysis in two different scenarios to study DWDM.

International Journal of Innovative Research in Science, Engineering and Technology

(An ISO 3297: 2007 Certified Organization)

Vol. 4, Issue 8, August 2015

1) DWDM System at 1310nm and 1550nm wavelength at 40Gbps, 50Gbps, 70Gbps for different lengths 40km, 50km, 80km for different number of users without soliton pulses.

2) DWDM System at 1310nm and 1550nm wavelength at 40Gbps, 50Gbps, 70Gbps for different lengths 40km, 50km, 80km for different number of users along with soliton pulses.

For the above two cases, graphs has been plotted between Q factor vs number of users, BER vs number of users. The spacing between two channels has been taken as 1nm. The concept of soliton pulses has been utilized as it has been analyzed that soliton pulses provide good response at higher data rates.

SCENARIO 1: a) DWDM sytem at 1310nm at 40Gbps, 50Gbps, 70Gbps for different lengths 40km,50km,80km for different number of users without soliton pulses.

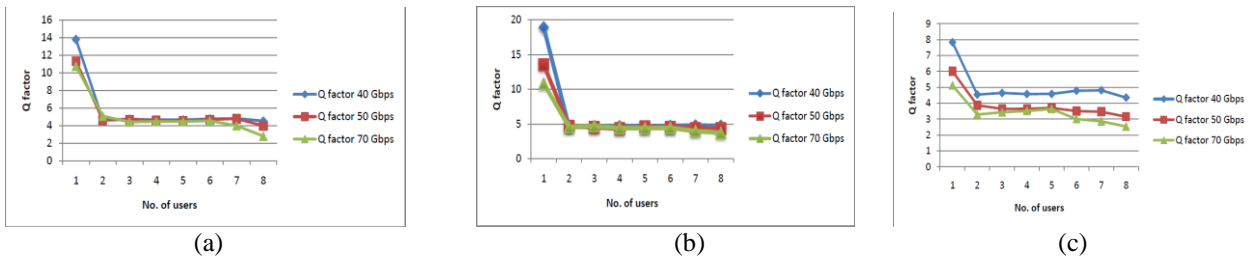

Figure 3: No. of user vs quality factor at (a) 40km; (b) 50km; (c) 80km for 40Gbps, 50Gbps and 70Gbps.

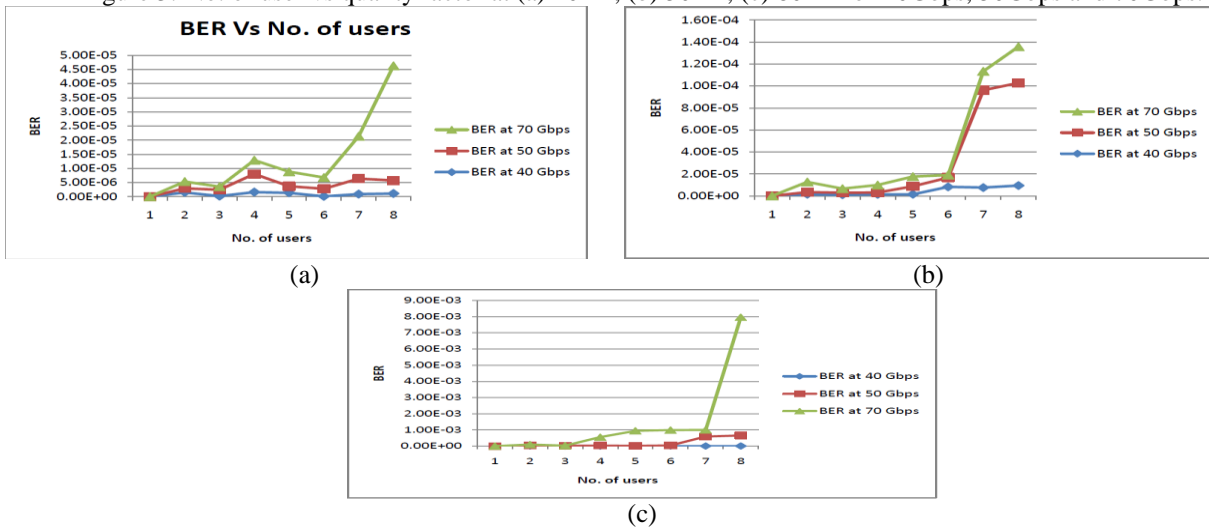

Figure 4: No. of user vs BER at (a) 40km; (b) 50km; (c) 80km for 40Gbps, 50Gbps and 70Gbps.

b) DWDM sytem at 1550nm at 40Gbps, 50Gbps, 70Gbps for different lengths 40km, 50km, 80km for different number of users without soliton pulses.

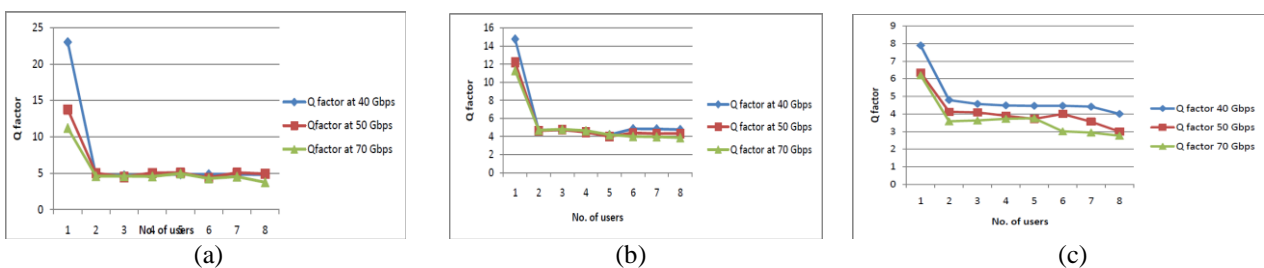

Figure 5: No. of user vs quality factor at (a) 40km; (b) 50km; (c) 80km for 40Gbps, 50Gbps and 70Gbps.

International Journal of Innovative Research in Science, Engineering and Technology

(An ISO 3297: 2007 Certified Organization)

Vol. 4, Issue 8, August 2015

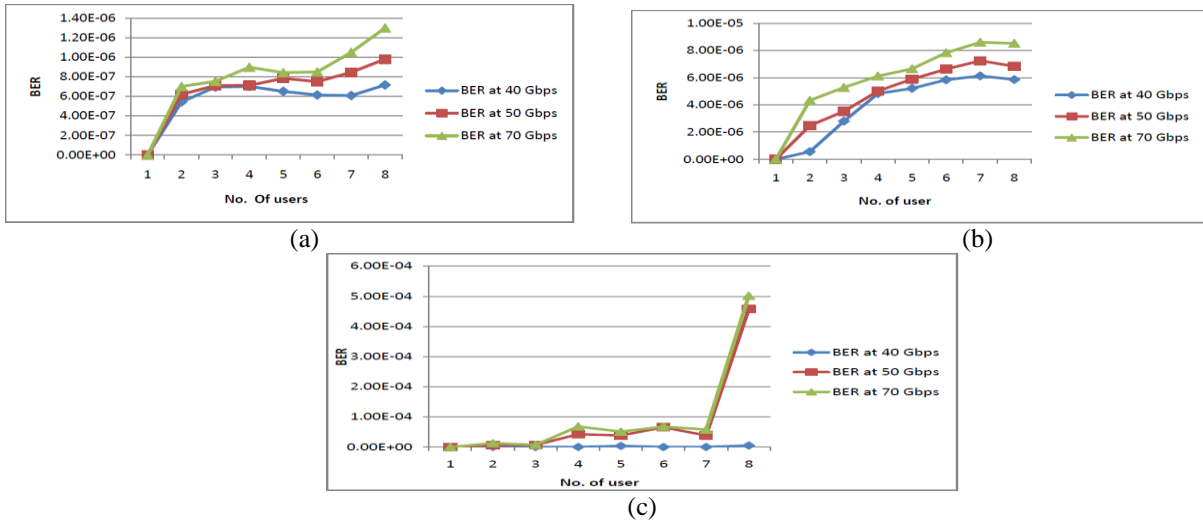

Figure 6: No. of user vs BER at (a) 40km; (b) 50km; (c) 80km for 40Gbps, 50Gbps and 70Gbps.

SCENARIO 2: a) DWDM system at 1310nm at 40Gbps, 50Gbps, 70Gbps for different lengths 40km,50km,80km for different number of users along with soliton pulses.

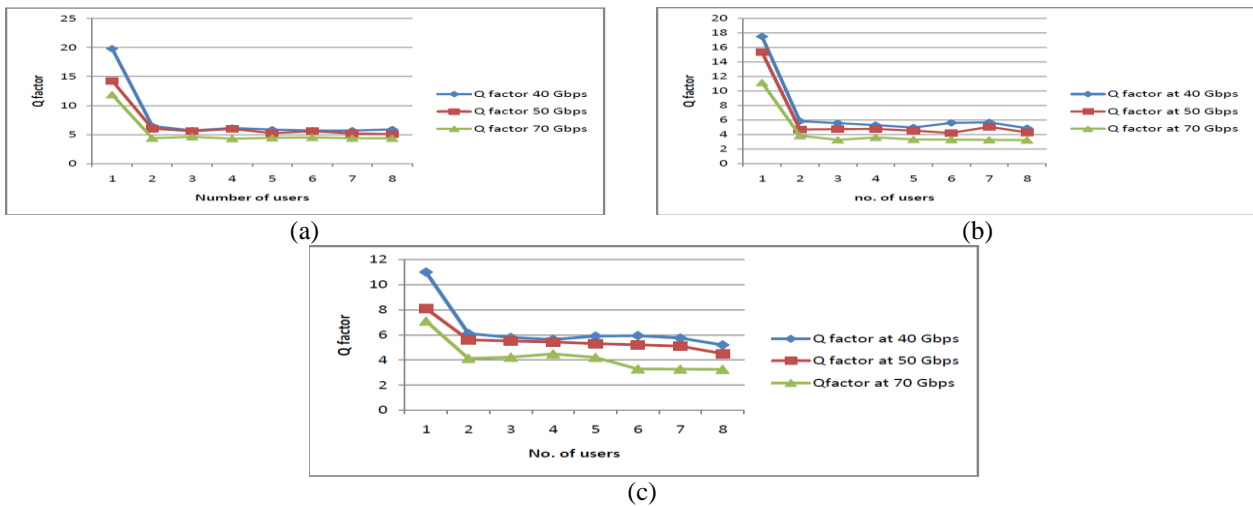
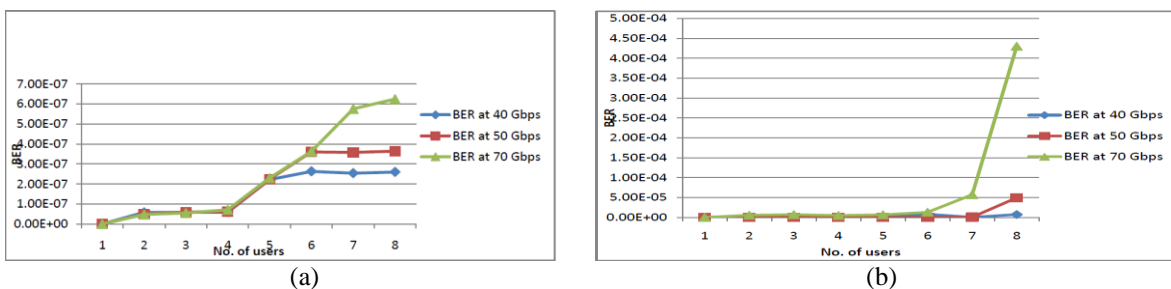

Figure 7: No. of user vs quality factor at (a) 40km; (b) 50km; (c) 80km for 40Gbps, 50Gbps and 70Gbps.



International Journal of Innovative Research in Science, Engineering and Technology

(An ISO 3297: 2007 Certified Organization)

Vol. 4, Issue 8, August 2015

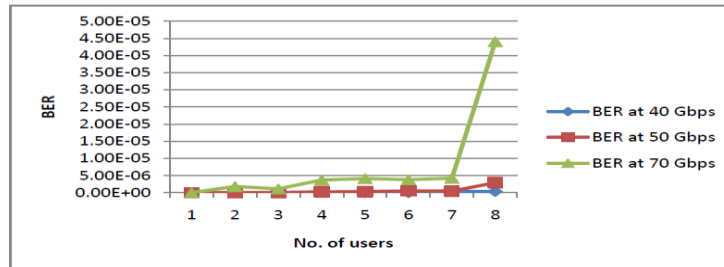

(c)

Figure 8: No. of user vs BER at (a) 40km; (b) 50km; (c) 80km for 40Gbps, 50Gbps and 70Gbps.

b) DWDM system at 1550nm at 40Gbps, 50Gbps, 70Gbps for different lengths 40km, 50km, 80km for different number of users along with soliton pulses.

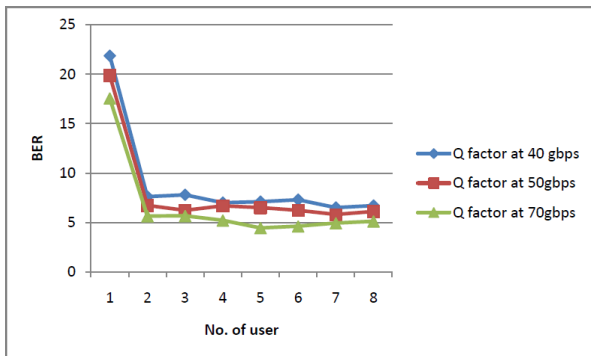

(a)

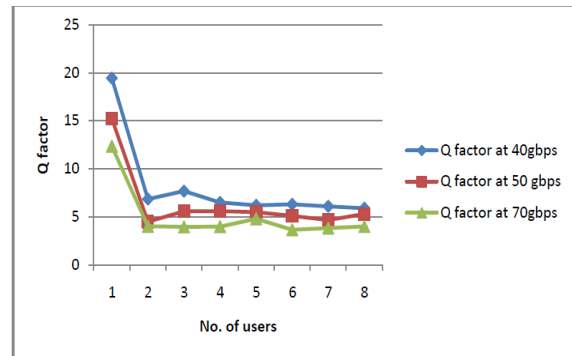

(b)

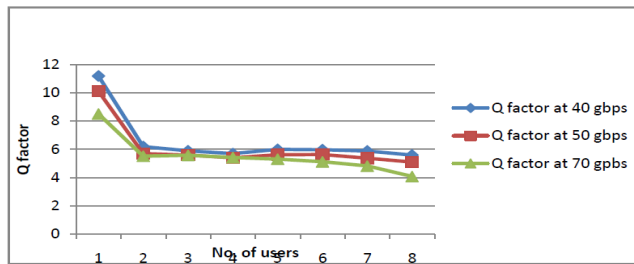

(c)

Figure 9: No. of user vs quality factor at (a) 40km; (b) 50km; (c) 80km for 40Gbps, 50Gbps and 70Gbps.

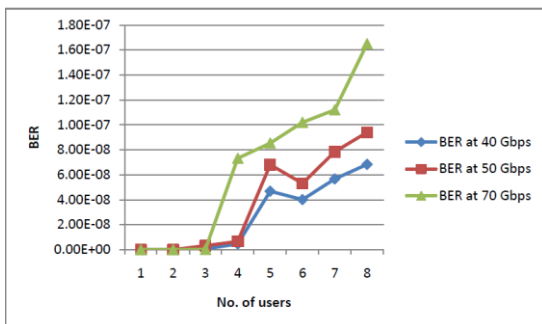

(a)

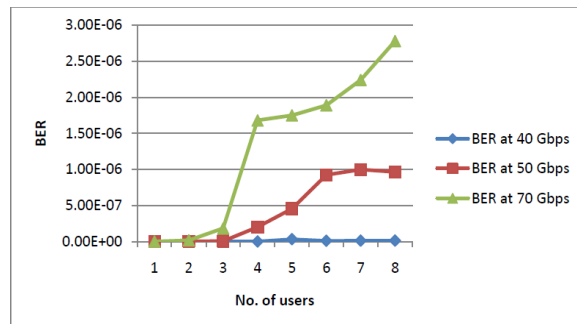

(b)

International Journal of Innovative Research in Science, Engineering and Technology

(An ISO 3297: 2007 Certified Organization)

Vol. 4, Issue 8, August 2015

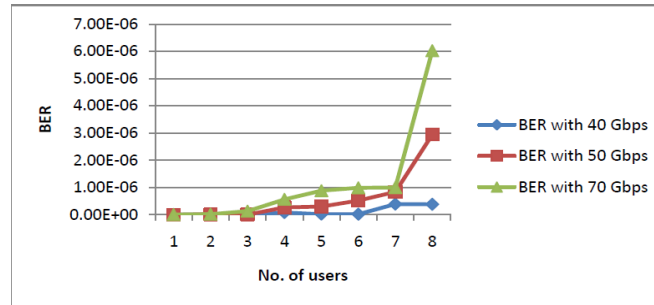

(c)

Figure 10: No. of user vs BER at (a) 40km; (b) 50km; (c) 80km for 40Gbps, 50Gbps and 70Gbps.

ANALYSIS:

- (a). From the graphs of number of users vs quality factor, we concluded that when the length of the optical fiber is least and the total data transmission capacity is least then the value of quality factor will be maximum and when the data transmission rate is increased or length is increased the value of Q factor will be diminished. Also when the number of user increases, value of quality factor decreases.
- (b). Similarly, from the graphs of number of users vs BER, we analysed that when the length of fiber is least and the total data transmission capacity is least then the value of BER will be minimum but as we increase length of fiber and data transmission capacity, the value of BER will increase.
- (c). We also analysed that at 1550nm, attenuation is minimum as value of quality factor and BER improves as compared to 1310nm.

IV. PERFORMANCE EVALUATION

(A). Comparison between simulation of DWDM system with/without soliton pulses:

(a) Comparison at 1310nm:

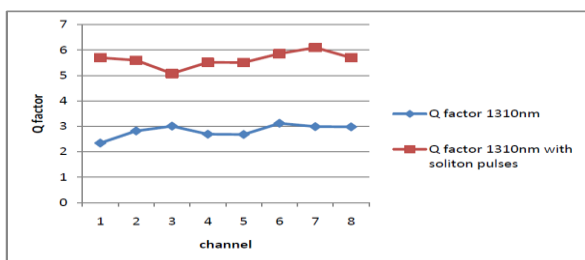

(a)

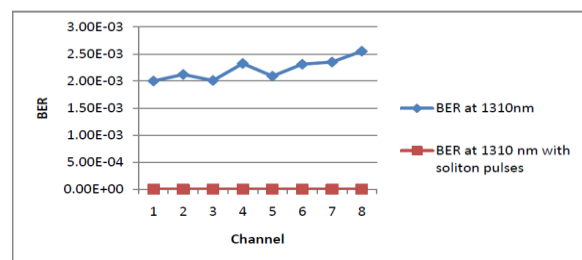

(b)

Figure 11: (a) Channel number vs Quality factor at 70km; (b) Channel number vs BER at 70km.

ANALYSIS:

The total capacity of the system is 640Gbps (80Gbps×8). From figure 11(a), as it can be clearly analyzed that Q factor is better at each channel for the case of soliton pulses. Whereas the value of Q factor for the other case is lower as corresponding to soliton pulse system. From figure 11(b), as it is clear from the graph that the value of BER in case of without considering the soliton pulse system is ranging from $2.52E^{-3}$ to $1.68E^{-3}$. Whereas when the second case is being considered then the BER is very less which is desired.

International Journal of Innovative Research in Science, Engineering and Technology

(An ISO 3297: 2007 Certified Organization)

Vol. 4, Issue 8, August 2015

(b) Comparison at 1550nm:

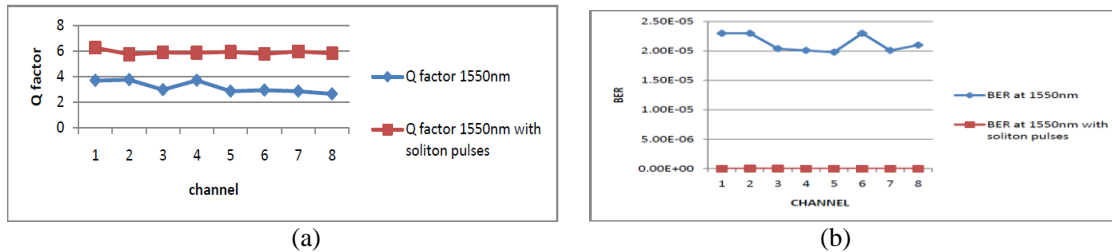

Figure 12: (a) Channel number vs Quality factor at 70km; (b) Channel number vs BER at 70km

ANALYSIS:

From the Figure 12(a), while considering the case without the soliton system the value of Q factor ranges from 2.65 to 3.76. In second case the value of Quality factor is improved, the value in second case ranging from 5.7 to 6.24. From figure 12(b), it can be analyzed that the BER value for system without having effect of soliton pulses is having higher value i.e. more bits are being corrupted. The value of the BER lies in range of E^{-5} . Whereas in the second case the value of BER is far better means less number of bits are corrupted and the value of BER lies in the range of E^{-9} .

(B). Comparison between simulation of DWDM system at 1310nm and 1550nm with soliton pulses:

Both wavelength 1310nm and 1550nm are the minimum attenuation wavelength. But the main issue is that at which wavelength the soliton pulses will perform; hence comparison has been performed by the help of calculation of Q factor and BER.

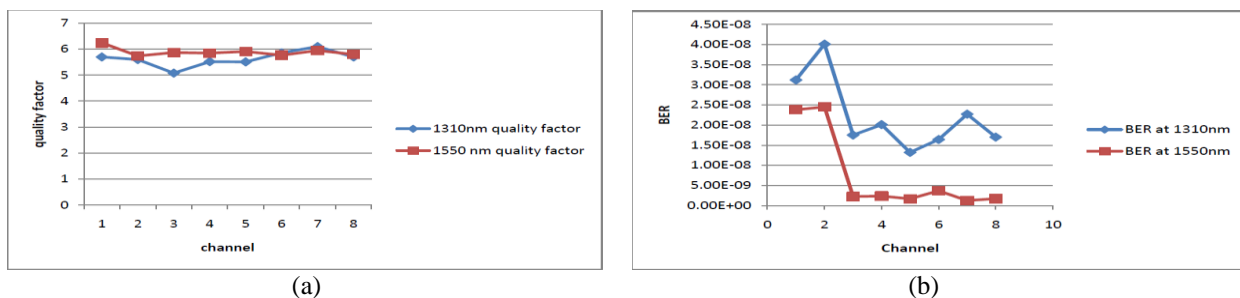

Figure 13: (a) Channel number vs Quality factor at 70km; (b) Channel number vs BER at 70km

ANALYSIS:

From the graph it can be clearly seen that the graph of 1550nm is having more effective value. Whereas the value of Q factor in case of 1310nm is lesser. Hence we can conclude from the graph that 1550nm is a better wavelength for simulation and designing of any system along with soliton pulses. At 1550nm we are getting good quality factor and lower BER which is our desired requirement.

(C). Comparative study between existing system and proposed system:

In the Existing system the author has worked up to 400Gbps having optical fiber length of 40 km and the range of BER obtained is given by $2.0E^{-5}$. The paper has been simulated at 1310nm for eight users and from the figure it can be seen that the value of BER are obtained in the range of E^{-7} . When we simulate the system at 1310 nm along with soliton pulses then the value of BER is obtained in the range of E^{-8} . When the system is simulated at 1550nm along with

International Journal of Innovative Research in Science, Engineering and Technology

(An ISO 3297: 2007 Certified Organization)

Vol. 4, Issue 8, August 2015

consideration of soliton pulses then the BER is obtained in the range of E^{-9} . From this all discussion we can conclude that the soliton pulses can be the good solution for the high data rate transmission up to the range of Tbps.

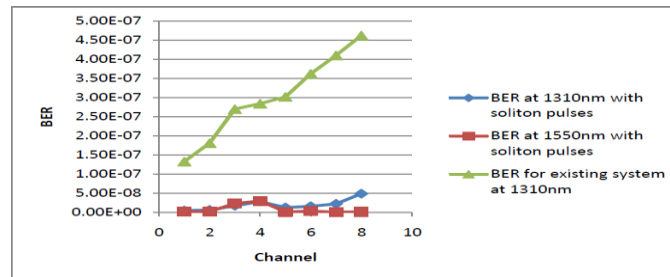

Figure 14: Channel vs BER at 1310nm, 1550nm at 40 km

V. CONCLUSION

When multiple wavelength transmitting over a single optical fiber these wavelength suffer cross talk due to low frequency spacing and the cross talk of wavelength affects the BER(Bit error Rate) at the receiver which determines the performance of the system. Quality factor is also a key component in the optical fiber to analyze the system performance of the of the DWDM system. As it is known fact that as the number of user increases system performance decreases. So there are three windows at which attenuation is minimum but here in thesis work has been done on two wavelengths, 1310nm and 1550nm. The effect of increasing length of the fiber and increasing data rates has been analyzed in the thesis and according to that the concept of Soliton pulses has been clubbed together so as to make the new effective system which can support higher data rate. The advantage of soliton pulse is that these pulses do not disperse.

The aim of the research was to simulate and analyze an improved DWDM system. Different scenario has been analyzed, which includes the data rates at 320Gbps, 400 Gbps, 560 Gbps at different lengths of 40 km, 50km, 80km. So the system has been designed and simulated on the optical software which is supporting 640 Gbps for 70km length. The simulated system is having some characteristics. Firstly it is equipped with soliton pulses that play an important role, because soliton pulses keep their shapes remain unchanged for long time. Then the amplifier used is SOA (Semiconductor Optical Amplifier). This amplifier is having characteristics that it can work effectively at both the wavelengths at 1310nm and at 1550nm. This amplifier works in the saturation mode. In this mode the gain does not vary. The flat band gain or we can say amplification is obtained in a better manner. This system is having is less complex because it does not contain loops; no dispersion compensation is used in this system. Data rate can increase to further higher rate but the main problem is of the degradation of system performance. The system performance is directly related to value of BER and value of Q factor. If the value of BER is below acceptance range that is (E^{-9}) then system is not viable or it can be called system is of no use. So as we increase the data rate at very high manner the value of Q factor degrades and BER value increases. DWDM system is working on increasing the capacity and distance of future DWDM products. DWDM can be supported for the data rate of higher of Tbps, so now the data traffic is growing exponentially in the world of computer network. DWDM technology is also most important in the telecommunication industry. Finally as the aim is to find out the new techniques so that more and more number of users can be supported along with higher security.

REFERENCES

- [1] Introduction to DWDM Technology, by Cisco systems.
- [2] Muralikrishna Gandluru, "Optical Networking and Dense Wavelength Division Multiplexing (DWDM)", Second Edition, Prentice Hall of India.
- [3] Jaroslaw Piotr Turkiewicz and Huug de Waardt, "Low Complexity up to 400-Gb/s Transmission in the 1310-nm Wavelength Domain", *IEEE Photonics Technology Letters*, Vol. 24, No. 11, June 1, 2012.

International Journal of Innovative Research in Science, Engineering and Technology

(An ISO 3297: 2007 Certified Organization)

Vol. 4, Issue 8, August 2015

- [4] Joon-Young Kim, Ho-Sung Cho, Sil-Gu Mun, Hoon-Keun Lee, and Chang-Hee Lee, Fellow, IEEE, "High-Capacity DWDM-PON Using Triple-Contact F-P LDs", *IEEE Photonics Technology Letters*, Vol. 23, No. 2, January 15, 2011.
- [5] S. Susskind and E. A. de Souza, "Transmission Limits Analysis of a 40 Channels DWDM System at 10 Gb/s Without Amplification", *IEEE Latin America Transactions*, Vol. 9, No. 3, June 2011.
- [6] K. Adachi, et al., "25-Gb/s multi-channel 1.3- μm surface-emitting lens integrated DFB laser arrays," *Journal of Lightwave Technology*, Vol. 29, no. 19, pp. 2899–2905, October 1, 2011.
- [7] Richard S. Vodhaniel, "The Effects of Fiber Type on DWDM System Performance", *Published in Journal of Light wave Technology*, 2000.
- [8] M. Jamshidifar, A. Vedadi, and M. E. Marhic, "Reduction of four wave-mixing crosstalk in a short fiber-optical parametric amplifier," *IEEE Photonics Technology Letters*, Vol. 21, no. 17, pp. 1244–1246, Sep. 1, 2009.
- [9] E. S. Son, S. B. Jun, Y. C. Chung "Repeaterless Transmission of Directly Modulated 10-Gb/s Signal over 200 km using Negative Dispersion Fiber", *OptoElectronics and Communications Conference OECC'06*, Taiwan, July 2006.
- [10] D. McCoy, P. Horak, B. C. Thomsen, M. Ibsen, and D. J. Richardson, "Noise suppression of incoherent light using a gain-saturated SOA: Implications for spectrum-sliced WDM systems," *Journal of Lightwave Technology*, Vol. 23, no. 8, pp. 2399–2409, August 2005.