

International Journal of Innovative Research in Science, Engineering and Technology

(An ISO 3297: 2007 Certified Organization)

Vol. 4, Issue 8, August 2015

Performance Test on a Four Stroke Single Cylinder Diesel Engine Using Biodiesel with Cooled EGR Method

Banku Venkataramana¹, P.Sagar², M.Venkateswarlu³, M.Ashok Kumar⁴

P.G. Student, Department of Mechanical Engineering, SSCET, Kurnool, Andhra Pradesh, India¹

Associate Professor, Department of Mechanical Engineering, Dr.KVSRIT, Kurnool, Andhra Pradesh, India²

Associate Professor, Department of Mechanical Engineering, Dr.KVSRIT, Kurnool, Andhra Pradesh, India³

Professor, Department of Mechanical Engineering, Dr.KVSRIT, Kurnool, Andhra Pradesh, India⁴

ABSTRACT: Biodiesel is an alternative to petroleum based fuel derived from vegetables oils, animal fats and used waste cooking oil. Transesterification process is the most common method for producing biodiesel and used as a fuel. In India the two primary biodiesels are jatropha and pongamia. In the present work jatropha and pongamia biodiesel blend B20 is used in a single cylinder with cooled EGR and the performance and emission characteristics of blend are studied. The results show that brake thermal efficiency of engine is increasing with increasing the percentage of EGR and then it is decreasing by increasing EGR percentage. The brake specific energy consumption is increasing with increase in percentage of EGR The BTE of PB20 is higher (2.75%) than the JB20.

KEYWORDS: pongamia biodiesel, jatropha biodiesel, cooledEGR

I. INTRODUCTION

Better fuel economy and higher efficiency with lower maintenance cost has increased the popularity of diesel engine vehicles. Diesel engines are used for bulk movement of goods, powering equipment, and to generate electricity more economically than any other device in this size range. Diesel fuel is moderately cheaper than gasoline and has a higher energy density, i.e. more energy can be extracted from diesel as compared with the same volume of gasoline. Therefore, diesel engine in automobiles provides higher mileage, making it an obvious choice for heavy-duty transportation and equipment. Diesel is heavier and oilier compared with gasoline, and has a boiling point higher than that of water. Even though the diesel fuel give more benefits, but in today's world, where fuel prices are increasing as a consequence of spiralling demand and diminishing supply, so we need to choose a cost effective fuel to meet our needs. Bio-diesel is one of the alternative fuels, which can be effectively used in diesel vehicles.

Bio-diesel refers to a vegetable oil or animal fat based diesel fuel consisting of long chain alkyl (methyl, ethyl or propyl) esters. Bio-diesel is typically made by chemically reacting lipids with an alcohol producing fatty acid esters. ASTM International (originally known as the American Society for Testing and Materials) defines bio-diesel as a mixture of long-chain mono alkylic esters from fatty acids obtained from renewable resources, to be used in diesel engines.

Bio-diesel is a clean, domestic, renewable fuel for diesel engines. It is made from agricultural co-products and by products such as soybean oil, jatropha oil, other natural oils, and greases. Bio-diesel, blend with petroleum diesel fuel and are free from sulphur. It is nontoxic and biodegradable. Bio-diesel has a higher oxygen content, which allows it to burn more completely, causing lower emissions. It is safer than petroleum diesel because it is less combustible. The flashpoint for Bio-diesel is higher than 130°C, compared with about 71.5°C for petroleum diesel Bio-diesel has excellent properties as a lubricant also.

International Journal of Innovative Research in Science, Engineering and Technology

(An ISO 3297: 2007 Certified Organization)

Vol. 4, Issue 8, August 2015

In the present energy scenario lot of efforts are being focused on improving the thermal efficiency of IC engines with reduction in emissions. Apart from the studies on the suitability and efficiency of these alternate fuels, the main concern is the amount of modifications required in the existing engines. Though bio-diesels can be directly used in diesel engines, there are many issues related to optimum performance and emission, which need to be addressed. As far as the internal combustion engines are concerned the thermal efficiency and emission are the important parameters for which the other design and operating parameters have to be optimized.

Pongamia Pinnata found as one of the most suitable non edible oil plant species in India. It can be grown in water logged, saline, alkaline soil and waste land and can withstand harsh agro climates. It is a medium sized evergreen tree with spreading crown and a short bole. The tree is planted in for shade and grown as ornamental tree. The seed contain 30% - 40% oil.

II. MATERIALS AND METHODS

The materials used to conduct the performance test on 4-stroke single cylinder diesel engine using bio-diesel is tabulated below

Table 1: Materials and their blends

MATERIAL	BLENDS
pongamia biodiesel	PB20
jatropha biodiesel	JB20

Method of cooled EGR (Exhaust Gas Recirculation) is used to conduct the experiment. Without EGR,5% EGR,10% EGR,15% EGR with PB20 and JB20 is used to conduct the experiment. Experiment was carried out at three injection timings 25.5, 27.5, 29.5 degree bTDC with three fuels diesel, B20 blend of jatropha and pongamia biodiesel. Then experiment carried with the 5%, 10%, 15% and 20% percentage of EGR at 25%, 50%, 75% and 100% load.

III. EXPERIMENTAL SETUP

The components of the experiment set up of the present work are detailed below.

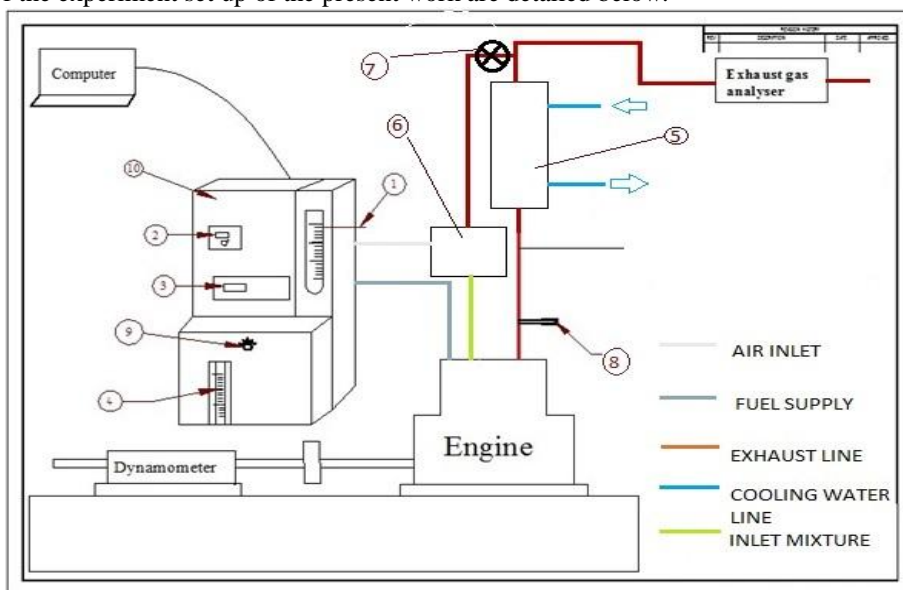

Figure 1: Schematic diagram of experimental setup

International Journal of Innovative Research in Science, Engineering and Technology

(An ISO 3297: 2007 Certified Organization)

Vol. 4, Issue 8, August 2015

- | | | |
|-------------------------|------------------------------|-------------------|
| 1. Burette | 5. heat exchanger | 9. Loading knob |
| 2. Load indicator | 6. Air inlet manifold | 10. control panel |
| 3. RPM indicator | 7. Exhaust gas control valve | |
| 4. water flow indicator | 8. Thermocouple (k type) | |

The experiments will be conducted on a single cylinder four stroke naturally aspirated direct injection water cooled diesel engine test rig. The engine is directly coupled to an eddy current dynamometer. The engine and the dynamometer are interfaced to a control panel.

The time taken for 10ml of fuel consumption is noted. By using density of fuel, calorific value of fuel and time for 10ml consumption the engine parameters Brake thermal efficiency, Brake specific energy consumption are calculated. The engine specifications are given below.

Table 2: Specifications of the Diesel engine test rig

Engine	4 stroke single cylinder CI engine
Make	Kirloskar
Power	5.0 kW @ 1500 RPM
Bore X Stroke	87.5 X 110 mm
Compression ratio	17.5:1
Connecting rod length	234mm
Dynamometer type	Eddy current with load cell
Load measurement	Strain Gauge load cell
Fuel and air flow measurement	Differential pressure unit
Speed measurement	Rotary encoder

Exhaust gas recirculation circuit:

The exhaust gas from the engine is at high temperature. The exhaust gas is allowed through the heat exchanger. The exhaust gas is cooled to require temperature by controlling the cooling water flow rate.

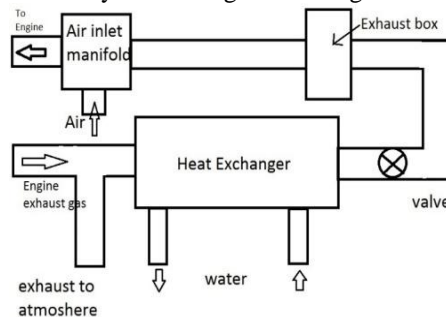

Figure 2: EGR circuit diagram

The EGR value is given by

$$EGR = 1 - \frac{m_{with\ EGR}}{m_{without\ EGR}}$$

$m_{with\ EGR}$ = mass flow rate with EGR, $m_{without\ EGR}$ = mass flow rate without EGR

International Journal of Innovative Research in Science, Engineering and Technology

(An ISO 3297: 2007 Certified Organization)

Vol. 4, Issue 8, August 2015

Measurement System:

Airflow measurement was done in by the conventional method U-tube manometer as well as by air intake DP unit in the control panel. Engine speed measurement was sensed and indicted by inductive pickup sensor in conjunction with digital RPM indicator. To measure the load on the engine, a eddy current dynamometer is attached to the crankshaft of the engine. A strain gauge type load cell mounted beneath the dynamometer arm measures the load and signals are interfaced with ADC card to give load in kg. The dynamometer was loaded by dynamometer loading unit situated in the control panel.

IV. EXPERIMENTAL PROCEDURE

The entire experimental investigation has the scheme as shown in figure below.

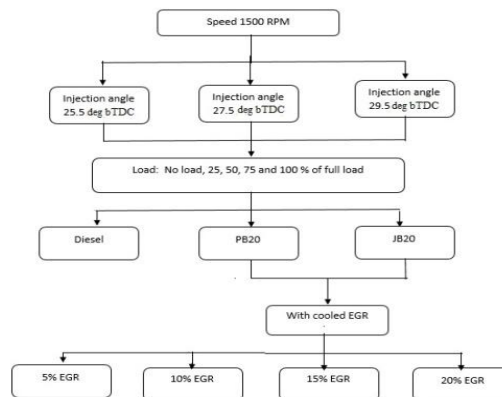

Figure3: Scheme of experimentation

Experimental Procedure:

1. Fill the fuel tank and start the engine.
2. After that engine is allowed to run at rated speed of 1500rpm at least 10 minutes for stabilization.
3. Apply the required load on the engine by adjusting knob and maintain the speed 1500rpm.
4. Note the time consumption for 10 ml of fuel, emission, smoke readings.
5. The performance and emissions are noted for all loads (no load, 25%, 50%, 75% and full load).
6. The above experimental procedure is repeated for the blends PB20, JB20.
7. The experiment is carried at 5%, 10%, 15% and 20% percentage of EGR with the blends.
8. The above procedure is repeated for 25.5, 27.5 and 29.5 injection timings.

Observations:

Fuel properties determined:

Table 3: Properties of fuel

Properties of fuel	Diesel	PB20	JB20
Flash point (°C)	48	69	57
Fire point (°C)	52	74	61
Density (kg/m ³)	821	837	825
Kinematic viscosity @ 40°C (centi stokes)	2.44	3.25	3.54

International Journal of Innovative Research in Science, Engineering and Technology

(An ISO 3297: 2007 Certified Organization)

Vol. 4, Issue 8, August 2015

Sample calculations:

The sample calculations are show for the observations shown in table 3.3for 75% load with diesel fuel at 180 bar injection pressure.

Table 4: Time of fuel consumption of fuel at different loads

Load in Watts	Time for 10ml fuel consumption (sec)
0	63
1250	47
2500	41
3750	26
5000	21

V. EXPERIMENTAL RESULTS

Experiment was carried out at three injection timings 25.5, 27.5, 29.5 degree bTDC with three fuels diesel, B20 blend of jatropha and pongamia biodiesel. Then experiment carried with the 5%, 10%, 15% and 20% percentage of EGR at 25%, 50%, 75% and 100% load. Variations of engine Brake Thermal Efficiency against load were interpreted in graphs. They are shown below.

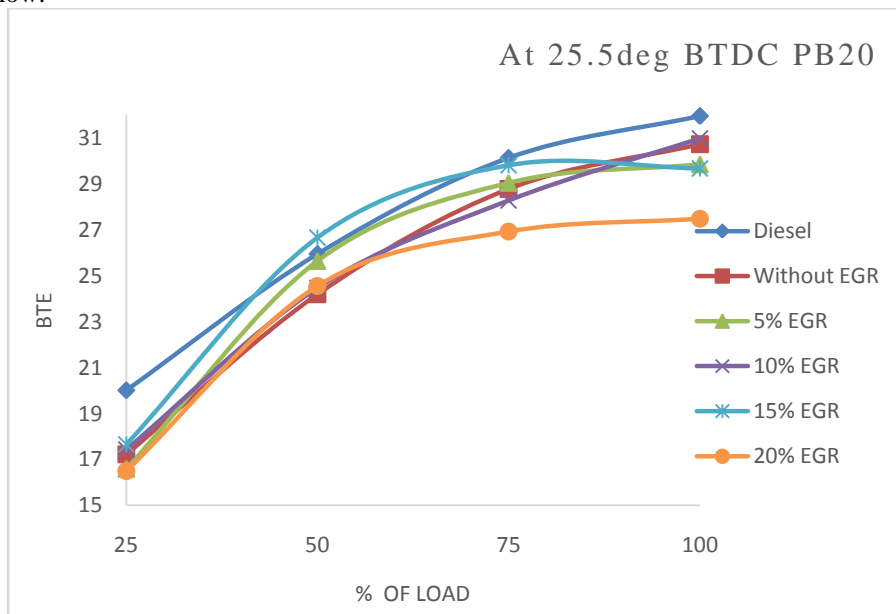

Graph1

Graph1: Variation of BTE at 25.5 degree IT for PB20 fuel with load and through different EGR rate. It is observed that the BTE of PB20 at 15% EGR is higher (2.46% at 50%load, 1.03% at 75%load) than PB20 without EGR. At 20% EGR the BTE of PB20 is lower (2.2%) than the 15% EGR.

International Journal of Innovative Research in Science, Engineering and Technology

(An ISO 3297: 2007 Certified Organization)

Vol. 4, Issue 8, August 2015

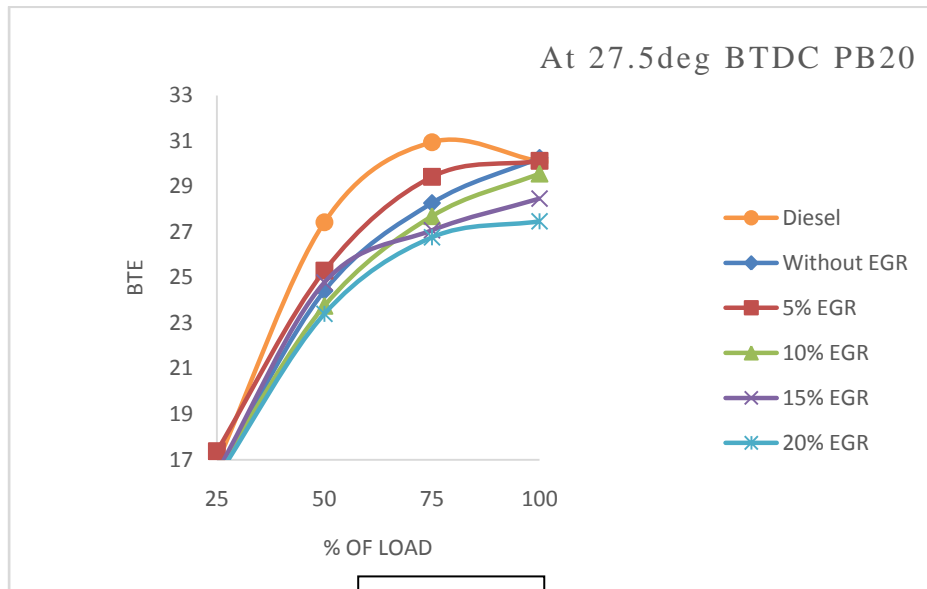

Graph 2

Graph2: Variation of BTE at 27.5 degree IT for PB20 fuel with load and through different EGR rate. It is observed that the BTE of PB20 at 5% EGR is higher (1.143% at 75% load and .914% at 50% load) than without EGR. After that with increase in percentage of EGR the BTE of PB20 is decreasing

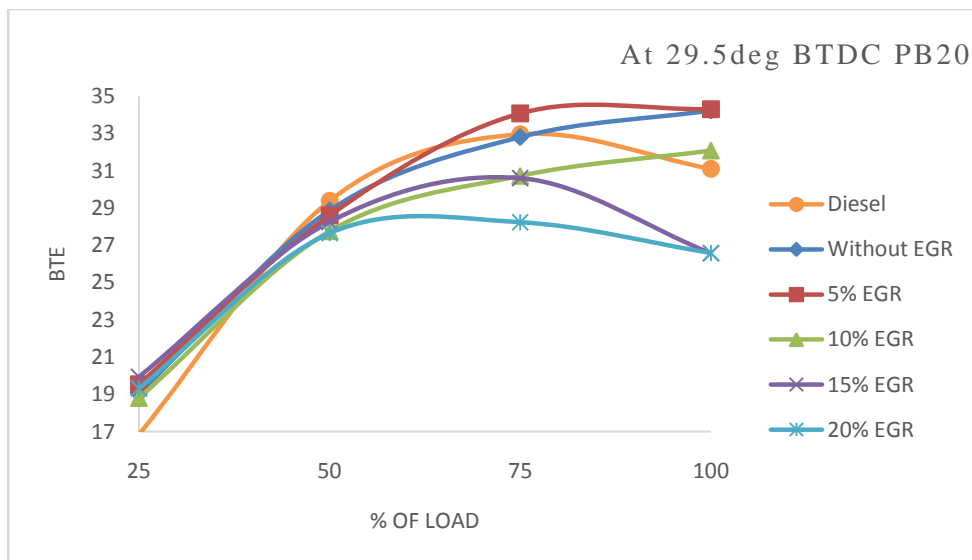

Graph 3

Graph3: Variation of BTE at 29.5 degree IT for PB20 fuel with load and through different EGR rate. It is observed that the BTE of PB20 at 5% EGR is higher (1.12% at 75% load and 3.2% at full load) than diesel fuel. After that with increase in % of EGR the BTE of PB20 is decreasing. This is due to the negative effect of decrease in oxygen concentration in the inlet gas of an engine

International Journal of Innovative Research in Science, Engineering and Technology

(An ISO 3297: 2007 Certified Organization)

Vol. 4, Issue 8, August 2015

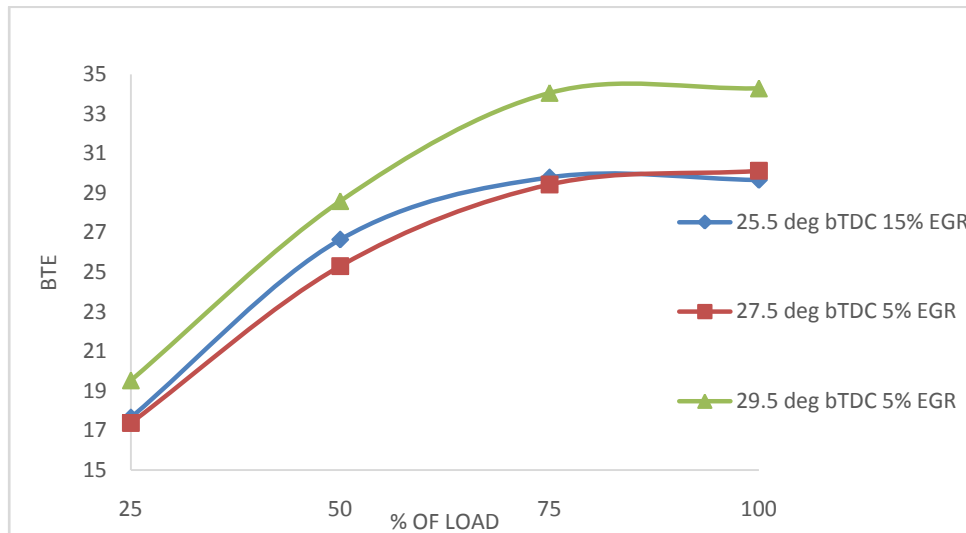

Graph 4

Graph4: The variation of BTE with load through different IT and EGR for PB20. The results show that the BTE of PB20 at 29.5 degree IT with 5% of EGR is better than other. This is due to the increase in IT. The increase in IT minimizes the effect of high viscosity PB20 compared to diesel and results in complete combustion.

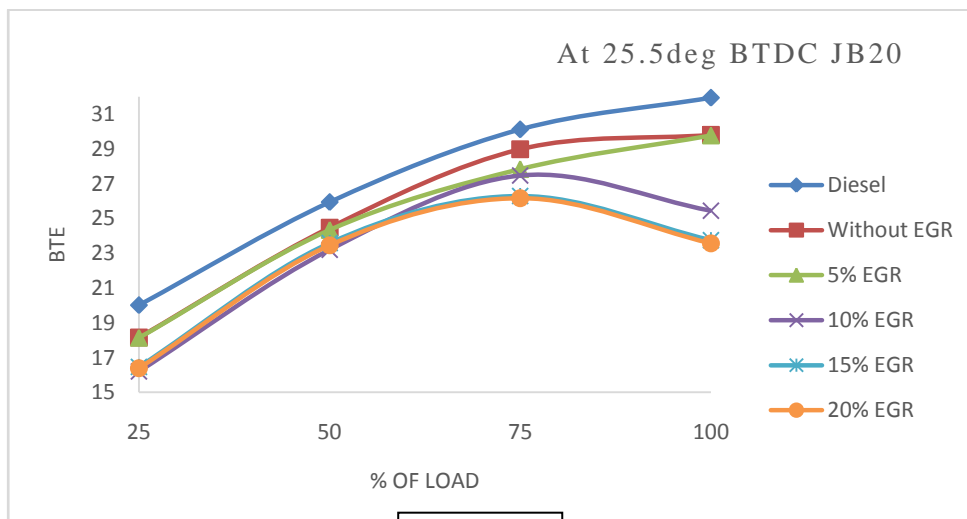

Graph 5

Graph5: Variation of BTE at 25.5 degree IT for JB20 fuel with load and through different EGR rate. From the test result it is observed that by increasing load the brake thermal efficiency of the diesel and the blend are increasing. The brake thermal efficiency of the blend is lower than that with diesel fuel throughout the entire range. It is also observed that brake thermal efficiency of the blend is increasing with decreasing the percentage of EGR. JB20 without EGR has BTE near to the BTE of diesel fuel.

International Journal of Innovative Research in Science, Engineering and Technology

(An ISO 3297: 2007 Certified Organization)

Vol. 4, Issue 8, August 2015

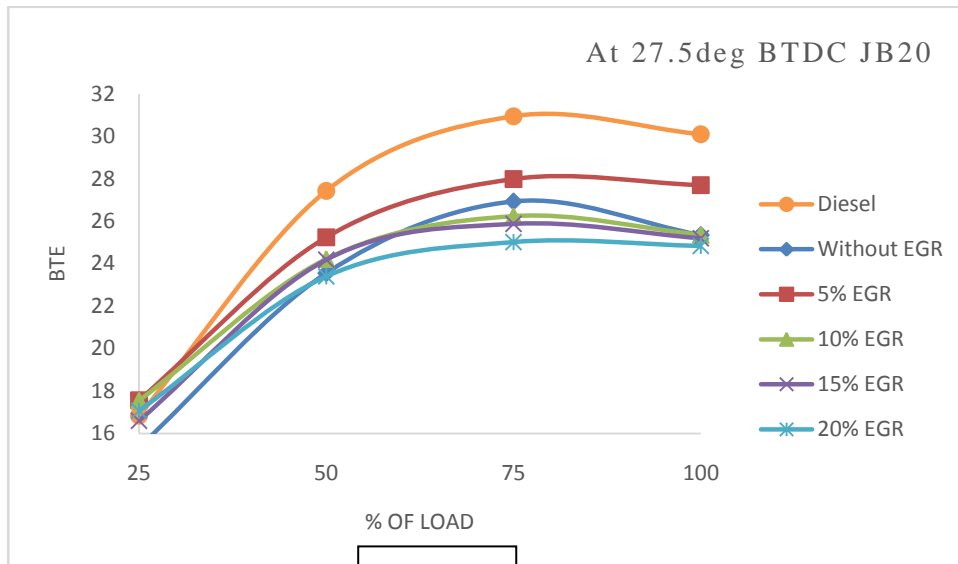

Graph 6

Graph 1: Variation of BTE at 27.5 degree IT for JB20 fuel with load and through different EGR rate. It is also observed that brake thermal efficiency of the blend is increasing with increasing the percentage of EGR up to 5% EGR. The BTE increased 1.69%, 2.94% and 2.336% than JB20 without EGR. After the 5% EGR the BTE is decreasing with increasing EGR.

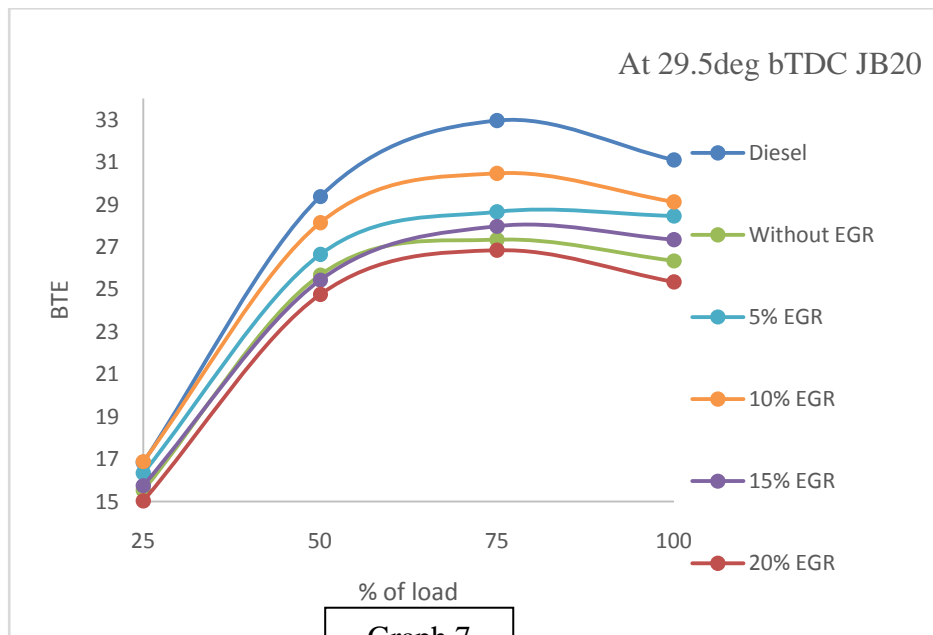

Graph 7

Graph 2: Variation of BTE at 29.5 degree IT for JB20 fuel with load and through different EGR rate. It is observed that at 10% EGR JB20 has Better BTE (3.99% at 50%load, 3.625% at 75% load and 2.77% at 100% load) compared to other EGR percentage. After the 10% EGR the BTE is decreasing with increasing EGR.

International Journal of Innovative Research in Science, Engineering and Technology

(An ISO 3297: 2007 Certified Organization)

Vol. 4, Issue 8, August 2015

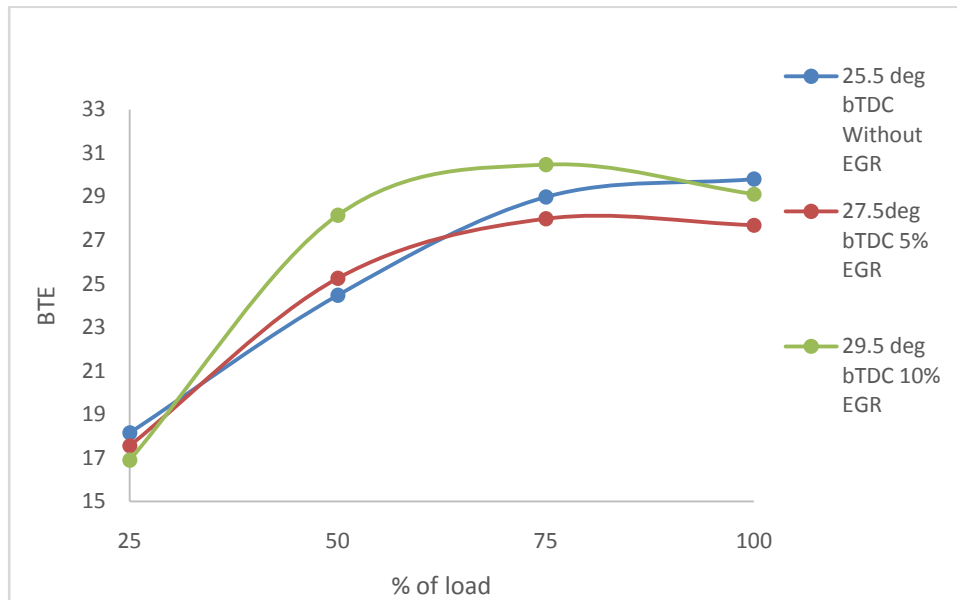

Graph 8

Graph8: The variation of BTE with load through different IT and EGR for JB20. The results shows that the BTE of JB20 at 29.5 degree IT with 10% of EGR is better than other. This due to increase in IT. The increase in IT minimize the effect of high viscosity JB20 fuel and result complete combustion

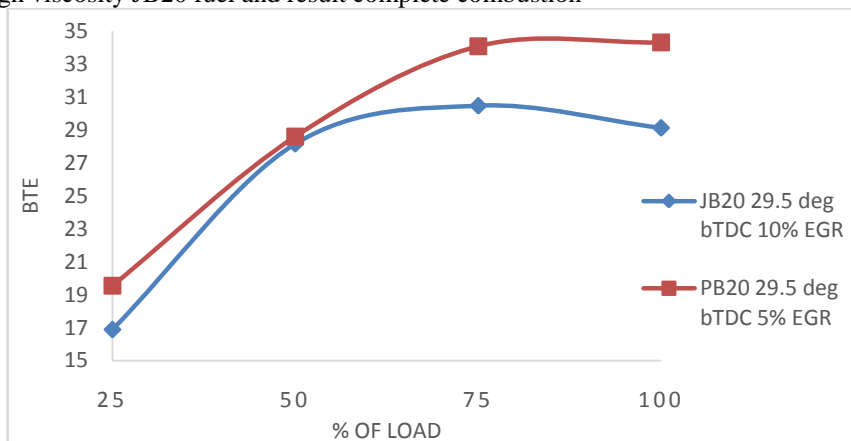

Graph 9

Graph9: Variation of BTE with load for PB20 and JB20. The BTE of PB20 is higher than JB20

V.CONCLUSION

Based on the observation, the brake thermal efficiency of engine is increasing with increasing the percentage of EGR and then it is decreasing by increasing EGR percentage. The brake thermal efficiency of the PB20 at 29.5 degree bTDC and with 5% EGR is higher (2.85%) than the brake thermal efficiency of JB20 at 29.5 degree bTDC with 10% EGR. Form the above it is concluded that the PB20 fuel is having better performance than the JB20 fuel.

International Journal of Innovative Research in Science, Engineering and Technology

(An ISO 3297: 2007 Certified Organization)

Vol. 4, Issue 8, August 2015

REFERENCES

- [1] Ajav E. A., Bachchan singh and Bhattacharya T. K. (2000) "Thermal balance of a single cylinder diesel engine operating on alternative fuels" *Energy Conversion and Mangement* 41, 1533-1541.
- [2] Amar Pandhare and Atul Padalkar (2013) "Investigations on Performance and Emission Characteristics of Diesel Engine with Biodiesel (Jatropha Oil) and Its Blends", *Renewable Energy*, 1-11
- [3] Baiju B., Naik M. K. and Das L. M. (2009) "A comparative evaluation of compression ignition engine characteristics using methyl and ethyl esters of karanja oil" *Renewable energy* 34, 1616-1621.
- [4] Bhupendra singh Chauhan, Naveen Kumar and Haeng Muk Cho (2012) "A study on the performance and emission of a diesel engine fueled with jatropha biodiesel oil and its blends" *Energy* 37, 616-622.
- [5] Forson, F.K., Odoro E. K. and Hammond-Dunkoh E (2004) "Performance of jatropha oil blends in a diesel engine", *Renewable Energy*, 1135–1145.
- [6] Ganapathy T., Murugesan K. and Gakhar R. P. (2009) "Performance optimization of Jatropha biodiesel engine model using Taguchi approach" *Applied Energy*, 2476–2486
- [7] Gaurav Dwivedi and sharma M. P. (2014) "Prospects of biodiesel from pongamia in India" *Renewable and sustainable energy* 32, 114-122.
- [8] Haiyong Peng, Yicui, Lei shi and kang yao deng (2008) "Effects of exhaust gas recirculation on combustion and emissions during cold start of direct injection diesel engine" *Energy* 33, 471-479
- [9] Huntalas D. T., Mavropoulos G. C. and Binder K. B. (2008) "Effect of EGR temperature for various EGR rates on heavy duty DI diesel engine performance and emissions" *Energy* 33, 272-283.
- [10] Jaffar Hussain, Palaniradja K., Alagumurthi N. and Manimaran R. (2012) "Effect of Exhaust Gas Recirculation (EGR) on Performance and Emission characteristics of a Three Cylinder Direct Injection Compression Ignition Engine" *Alexandria Engineering Journal* (2012) 51, 241–247
- [11] JinlinXue, Tony E. Grift and Alan C. Hansen (2011) "Effect of biodiesel on engine performances and emissions" *Renewable and Sustainable Energy*, 1098–1116.
- [12] Jothithirumal B. and Jamesgunasekaran E. (2012) "Combined impact of biodiesel and exhaust gas recirculation on NOx emissions in DI diesel engines", *ICMOC2012*
- [13] Kothandaraman C. P. and Subramanyan S. (2008) "Heat and Mass Transfer Data Book" New Age International, 196.
- [14] Lu-Yen Chen , Yi-Hung Chen , Yi-Shun Hung , Tsung-Han Chiang and Cheng-Hsien Tsai (2013) "Fuel properties and combustion characteristics of jatropha oil biodiesel–diesel blends", *Journal of the Taiwan Institute of Chemical Engineers* 44, 214–220
- [15] Narayana Reddy J. and Ramesh A. (2006) "Parametric studies for improving the performance of a Jatropha oil-fuelled compression ignition engine" *Renewable Energy* , 1994–2016.
- [16] Sunilkumar R. Kumbhar, H. M. "Dange Performance Analysis Of single Cylinder Diesel Engine, Using Diesel Blended with Thumba Oil" (IJSCE) ISSN: 2231-2307, Volume-4, Issue-1, March 2014

BIOGRAPHY



B. Venkataramana, graduated (Mechanical Engineering) from JNTU Anantapuramu in 2012 and is pursuing M. Tech (Thermal Engineering) at Stanley Stephen College Of Engineering and Technology, Kurnool under JNTU Anantapuramu. His areas of interest are Internal Combustion Engines, Heat transfer and Thermal Engineering-II.



P. Sagar, graduated (Mechanical Engineering) from GPREC Kurnool, SK University, M.Tech (Advanced Manufacturing System) From SVITS ,JNTU Hyderabad and His areas of interest are composite materials, Refrigeration and Air Conditioning.



M. Venkateswarlu, graduated (Mechanical Engineering) from GPREC Kurnool, SK University, M.Tech (Production Engineering) From SVUCE Tirupathi and His areas of interest are thermal engineering, Production, Robotics.



Dr. M. Ashok Kumar, working as a professor in Department of Mechanical Engineering in one of the reputed colleges in the Kurnool Dist. His area of research is Polymer Nanocomposites/Hybrid Nanocomposites and Characterization. He published more than 50 National and International Journals so far. He attended more than 10 international conferences and workshops. He graduated from JNTUCEA, Anantapuramu with distinction. Upon his B.Tech (Mechanical), he did his M.Tech (Machine Design) in Govt. College of Technology, Coimbatore, Tamilnadu. Then he has done his Ph.D in Mechanical Engineering at JNTUA Anantapuramu.