

Design of an Electrically Operated Compact Vehicle for Physically Challenged

K.S.Prithiv¹, C.Jagadeesh Vikram², G.Kalaiarasan³ & A.Thamaraiselvan⁴

Assistant Professor, Department of Automobile Engineering, Bharath Institute of Science and Technology.
Bharath University, Chennai, India.

ABSTRACT: At present, vehicles for physically challenged been available through exterior modifications and custom adjustments of user. These adaptations may not be fully stable and secured. In order to satisfy their needs and to cope up with current Economic status (petrol hike and environmental hazards), an alternate energy been utilized for the operation of vehicle. Here we design an electrically powered steer able vehicle of 35 Km/h cruising speed. It is a battery operated vehicle that is very economical with low maintenance cost and zero pollution. The vehicle consists of long retention chargeable battery, signal receiving probes, electrical connections with reverse DC motor. Electric current is the prime source of which vehicle been operated. These provisions increase the accustom usage of vehicle in future.

Hence all our efforts been grouped together on the basis of service and care for others. For the purpose of Design and Simulation the software's like Pro-e and Auto-Cad were employed effectively.

KEYWORDS: Physically Disabled, Variable steering column, Reverse motor mechanism, Electronic Bikes, DC changeover relay, DC motor.

I. INTRODUCTION

Due to the crisis situation, now there been scarcity of fuel and it would results in reduced operation of vehicles and trade ships. According to a verdict "It is estimated that India's fossil fuel dependency on other countries currently from 70% to 82% in 2012. In order to overcome the dilemma, energy from natural resource or alternate energy been utilized. Government has reduced the custom duty of the imported components to 10% and it would arouse the interest among all in favour. Here Electric energy is the prime source been employed for the operation of vehicle for Disabled.

Introduction of Electric vehicle is a modern innovation and it been available in the market. But for the case of disabled, they may not have properly secured vehicle to travel from one place to other for satisfying their needs. Now a day's some adaptations and modifications had been carried out through providing extra wheels on the rear, but it will not results better in all factors? In order to acquire safety and security in all purpose, a new generative design of electrically operated vehicle been adapted specially to overcome the failures such as imbalanced load distribution and stability aspects. The meritorious advantages were highlighted below:

- Eco friendly vehicle (free from environmental hazards).
- Less maintenance
- Ease of repairs and replacement of parts.

It also possess various peculiar features and modern adaptations like

- Single hand driving control.
- Variable steering column length adjustment.
- Reverse motor mechanism.[1]

As a nation of keen minds, the answer lies in innovation, which always been the force behind the powerful changes in our times. It is the most sustainable invention recognized for applying technology to a strong business model and commercial potential has been the Electric vehicles.

International Journal of Innovative Research in Science, Engineering and Technology

(An ISO 3297: 2007 Certified Organization)

Vol. 4, Issue 6, June 2015

II. HISTORY OF ELECTRICAL VEHICLES

In Late 1860 the earliest references to the electrically operated vehicle can be found in patents. As the years been passed the succession of E-bikes rejuvenates now due to non eco friendly nature and hike in fuel demand.

These vehicles were considered as a new technical green product and a potential industry for many countries. Now a day in this modern world the E-bikes spreads their roots in various fields like transportation, paramedical...etc.

Merits of Electric vehicle

The fuel costs for electric power are approximately 25% the cost of gasoline power.

- Environmental friendly (no exhaust gases at point of use).
- No trips needed to a gas station, it can be easily recharged at home or in charging stations.
- Can be used in V2G system.
- Lower maintenance costs and fewer maintenance activities.

However, they may possess' innumerable advantages but at the same time there be some little considerable remarks like longer battery "fill up" or recharge time.

General needs

A need is present for a compact two seated vehicle for physically challenged powered by alternative energy that will be marketable for intra-campus and intra-community travel. The vehicle must address the problems of pollution, oil dependency, oil consumption, parking, and money spent on gasoline. It must be of high-quality, safe, aesthetically appealing, weatherproof and capable of being used all year. It should also solve the purpose of make by promoting assistance by all means.

One of the important aspects of this design is customer appeal. In addition to the aesthetics of the vehicle and reliability, the ease of use and comfort of the driver are important factors in creating an appealing vehicle. In order to make an economically feasible and desirable vehicle, several assessments of customer needs and desires were used to define what constitutes comfort, reliability and usability for the consumer.

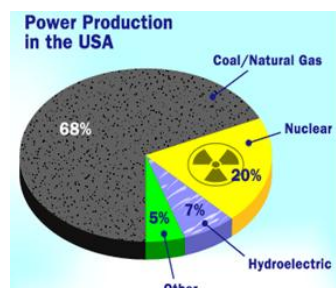

III. DESIGN FEATURES

Electric vehicles are fascinating to build and drive, even taking into consideration the limitations as outlined above. Electric vehicles are so simple in overall construction that they can easily be built by people with basic construction skills. In the simplest form, such as in a high school class, a very basic electric go cart can be built that can consist of a simple wood frame built out of 2" x 4"s, basic wheels, an electric motor, a car battery and a momentary electrical switch to turn the electricity on and off as a gas pedal. A more sophisticated system would use a go-cart body made out of steel (or perhaps converted from an existing gasoline go-cart), with the same elements as the wooden cart would use. Simple electric vehicles as just described can probably be built in two weeks with minimal skills.

Main Categories of 3-wheeled electric vehicles

Due to the vagueness in motor vehicle laws, any three wheeled vehicle that can travel over 31 mph (50 Km/h) may be classified as a motorcycle. This classification does not depend on whether the operator is fully enclosed by a "cage" or exposed to the elements. Several automotive start-up companies made their initial design as three wheeled

International Journal of Innovative Research in Science, Engineering and Technology

(An ISO 3297: 2007 Certified Organization)

Vol. 4, Issue 6, June 2015

vehicles, because the motorcycle classification does not require the same costly battery of crash safety testing as a four wheeled vehicle. For design purposes, three wheeled vehicles are divided into 2 categories.

1 wheel in front and 2 in rear and then it are known as delta design or the traditional design (tricycle).

2 wheels in front and 1 in rear are known as tadpole design.

In some vehicles the cabin is enclosed. These include Twine, Myers Motors Nmg. They also have independent suspension allowing the vehicle to tilt or lean. The first 3-wheel design is a fully enclosed, somewhat Egg-like shape... The second conceptual design is a little lower to the ground and more aerodynamic. The driver would be seated in a cockpit. The last design is a boxy design with open on both sides with 2 Wheel Configuration or 3 Wheel Configuration or 4 Wheel Configurations.

Application:	4-Wheel automobiles:	3- Wheelers with two front wheels:			2- Wheel Regular motorcycles				
	Rear drive: Corvette, Porsche...	Front drive: Civic, Golf ...	Rear engine and rear drive: Scorpion, T-Rex, Cyclone et G-Max	Two front driving-steering wheels: New 3-Wheeler concept			Bomb	Custom	Tourism
				Bomb	Custom	Tourism	Bomb	Custom	Tourism
A) Practical for passengers and luggages / Snow traction / Collision protection		1st							
B) Acceleration 1/4 mile	2nd		3rd	3rd			1st		
C) Motorcycle free-air-freedom / Custom lock / Simple					2nd			1st	
D) Race car sensations / Formula 1			1st						
E) Motorcycle free-air-freedom / Power / Tourism						1st			2nd
F) Fast and fun to drive on a winding road or track	1st		2nd	1st			3rd		

Security: The vehicle possesses comfortable seats and well spaced cabin with secured fittings. This adaptive design been made according to prescribed limits of the user especially for disabled. However, due to the expectations of the potential customers surveyed, the vehicle will have many peculiar features with recommended solutions.

Size and capacity: The needs statement for this project addresses a desire for a “compact” vehicle that will help alleviate parking concerns. The full dimension and the carton dimensions of the vehicle are 95.5×52.5×89cm and 100×57.5×54cm. The design opted for the vehicle comes under in traditional or delta types having one wheel on front and two on the rear. There is more spacious area with a limited seats (1+1) and separate luggage spaces.

Reliability: The criteria for reliability will be based on the life of the vehicle and the hours of operation between service and maintenance. A reliable source of information for these specifications can be obtained from the electrical vehicle with maintenance schedules and life spans. In addition to the regular maintenance, usage conditions must be considered in the overall design. This will be accounted for by assuming vehicle usage at the vehicles top speed of 25 mph over rough terrain including speed bumps, potholes, and rough brick streets.

International Journal of Innovative Research in Science, Engineering and Technology

(An ISO 3297: 2007 Certified Organization)

Vol. 4, Issue 6, June 2015

Technical specifications of three wheel electric vehicle

Number of wheels	3
Motor power	350W
Battery capacity	17AH
Load capacity	95 Kgs/190 Ibs
Charging time	6 hours
Recharge times	> 280 times
Max speed	25-35 Km/h
Range	40 Km/24.8 miles
Input voltage of charger	100V, 110V,220V
Brake	Hand rear brake
Diameter of Wheel	12 inches & 14 inches
Net weight	70Kgs/60.2Ibs
Color box size	105×32×43cm more convenient and lock stable quality

IV. MECHANICAL ASSEMBLIES

Frame: The frame for this vehicle is outside the scope of this design, however, something must be constructed to give the vehicle structure to hold up the cab components and define a general shape. Aesthetics is a driving force in the general shape of the cab and frame. For the points where the cab structure is part of the frame, a full tube chassis would give the best rigidity and strength. From customer interviews and from the design team's opinions a low slung, sleek looking vehicle would have the most aesthetic value and a Solid Edge mock-up of the vehicle.

This would also lower the center of gravity of the vehicle and reduce the overall weight of the vehicle. Since the frame is not part of the scope of this project, it has not been fully designed or optimized. Material selection is being left at the discretion of the fabricator who will be building the frame. The restrictions being giving to him are the outside dimensions of the tubing must be reasonably close to the concept to allow for other systems to fit. Also, the materials used must be cost effective and currently has some materials which may be used for free.

Therefore only some material will need to be purchased for the prototype. As a note, the fabricator chosen has had experience building tube framed type and buggies, so his judgment will yield a frame that will be more than strong enough for this projects purpose.

Suspension system: For the suspension of the vehicle, a coil spring suspension system has been chosen for the prototype. This system was chosen for several reasons. This system takes up the least amount of space in the front end of the vehicle which leaves more room for the batteries and steering systems.

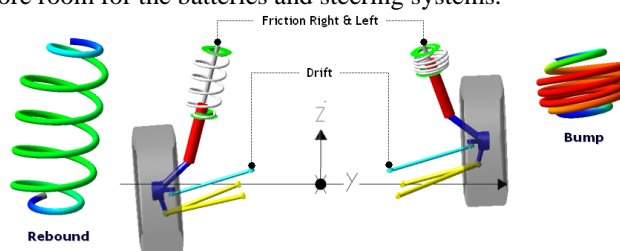

Fig: 2- Suspension system (Coil Spring)

International Journal of Innovative Research in Science, Engineering and Technology

(An ISO 3297: 2007 Certified Organization)

Vol. 4, Issue 6, June 2015

However, testing of the prototype will be used to determine if this setup is suitable for the final design. The most opted suspension system for making this design is coil spring suspension system.

This type been commonly employed in vehicles and the road wheel is positioned in the transverse plane using tubular suspension link at the bottom and a drive shaft at the top. A longitudinally mounted radius arm connects the wheel end of the link to the vehicle body and provides longitudinal stiffness and driving thrust.

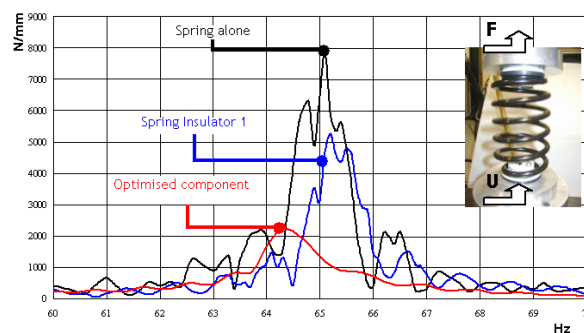

Fig: 2- Analytical illustration on spring action

Materials employed for Exterior and Side Panels:

The vents will be made from polyethylene. Mock-ups of the dash have been completed to aid making a decision of defogger placement. By using, the same system of fasteners to mount the defogger as is being used in the rest of the vehicle was determined to be desirable.[3] A switch will be used to power the defogger and it use of the same switches for all components of the cab is advantageous. These materials were researched for their ease of forming, ease of drilling, low cost, and good visibility Properties. Some of the best PVC materials that to be employed on making exterior panel and body assemblies be

- Polyethylene.
- Polypropylene.
- Polyethylene Terephthalate.
- Polycarbonate (lexan).
- Polyacrylic.

Polypropylene is the most suited material which has high thermal resistive nature and design flexibility.

1. Density, g/cc, ASTM-D782A: This test determines the material weight in grams per cubic centimeter, which means 1 cubic centimeter of our polypropylene resin would have an average weight of .9 grams.

2. Notched Izod Impact, FT-lbs. /in., ASTM-D256-A: This test determines the force used to break a sample of our polypropylene using a pendulum type hammer which is dropped from a standardized distance.[2] A notch is milled into the sample to concentrate stress to that point which promotes a brittle fracture. The tests are reported in terms of energy absorbed per unit of sample width.

3. Tensile Strength at Yield, lbs. /sq.in. ASTM-D638: This test determines force taken to break/ tear a polypropylene sample at a speed rat of 2 inches/minute and percentage of elongation at time of yield or break. It took 4000 lbs./sq.in. of force with 10% elongation at time of yield or break.

4. Deflection Temperature, in Degrees, ASTM-D648: This test determines at what temperature a polypropylene sample exhibits deformation with a specified force applied to the sample bridged across a test apparatus. The test uses a 66 psi load and a 264 psi load and determines deflection temperature at which point that the sample deforms .010 inch.

5. Water Absorption, % in 24 hrs, ASTM-D570: This test determines the relative rate of absorption of water by plastics when submersed for a 24 hour period. Samples are preconditioned (dried) before the test. The moisture content is very

International Journal of Innovative Research in Science, Engineering and Technology

(An ISO 3297: 2007 Certified Organization)

Vol. 4, Issue 6, June 2015

intimately related to such properties as electrical insulation resistance, dielectric losses, mechanical strength, appearance and dimensions.

Seat and Floor material:

Leather and rexin materials been employed for various purposes such as exterior fittings and surface (floor) mountings. Leather is the most suited material for the seating and floral works.

Leather is an organic material and as a result you work with it and handle it in a completely different fashion and manner than you would with synthetic materials. In many respects real leather is far easier to work with than synthetics and far more forgiving of minor mistakes or inconsistencies, up to a point.

Leatherworking can be very addictive. It seems to get inside your soul. It's a very therapeutic craft and many people find a deep almost mystical place of 'being' when they're working the material. Many psychiatric clinics use leather working classes as part of primary therapy. I personally think a lot of it has to do with the smell of raw leather and the fact that 98% of work is done exclusively with hand tools. Some have suggested that we all carry in the core of our brains chemical memories from the far distant past when our ancestors relied on leather as a mainstay of daily existence.

No matter what the reasons are it remains a fact that working with leather is relatively easy, enjoyable and sometimes profitable. Relatively leather is an incredibly strong yet supple material that is extremely durable if properly cared for. Well-made leather items can provide good service for generations over several decades, sometimes centuries of time.

Weight	Thickness	Weight
4 oz.	1/16"	4 oz.
5 oz.	5/64"	5 oz.
6 oz.	3/32"	6 oz.
7 oz.	7/64"	7 oz.

Wind shield: The windshield should be made out of a substance with safety in mind. While conventional car windshields are useful, I have found them to be generally too heavy for my vehicles. Instead, I prefer to use "unbreakable" Lexan type plastic. I normally use the 1/16" thick lexan and for strength, design the windscreen so that it is curved. It is also possible to mould the windscreen using either a vacuum or compression system, though this requires a rather high degree of construction skill.[1]

Tyre material: The efforts are continuously being put to improve the existing tyre materials and to introduce new materials for meeting tyre requirements better. Several types of fabric cord materials are in use for tyre piles. Rayon was introduced in 1938 as a tyre cord material to replace cotton. This material is durable, produced a soft ride, and was more resilient and less expensive than cotton it has tensile strength of 648,110kN/m². In 1962 polyester cord been been employed and it possess tensile strength of about 717,050 KN/m².

They also have numerous merits such as high resistance to heat, flexibility and longer life. In the year 1968 rubber is used a cord for tyre material. They are the compounds of natural and synthetic elastomers. In order to increase the wear and abrasion resistance the large amount of carbon black are added to tread. These hard compounds provide minimized wear and poor traction. Now -a-day's synthetic rubber is mostly used. There are other variants like

- Chloroprene rubber (CR).
- Styrene-butadiene rubber (SBR).
- Polyisoprene rubber (IR).
- Ethylene Propylene rubber (EPR).
- Polybutadiene rubber (BR).
- Isobutene-isoprene rubber (IIR).

International Journal of Innovative Research in Science, Engineering and Technology

(An ISO 3297: 2007 Certified Organization)

Vol. 4, Issue 6, June 2015

But according to design and manufacturing aspects one can choose the tyre material of maximum benefits. Polyisoprene rubber possesses maximum merits such as resistivity, flexing, good resistance to wear, more resilient, less cost and excellent ageing resistance.

V. ELECTRICAL ASSESSORIES

Batteries: Batteries, like fuel cells, turn chemicals into energy. Unlike fuel cells, the chemicals in batteries are entirely enclosed so when the reactants are used up, the battery can no longer produce power and must be replaced. Batteries are a very popular form of energy because of their availability and recharge ability. Though batteries tend to be heavy, they are less expensive than other forms of energy like fuel cells. There are also several different kinds of batteries to choose from.

- Lead-Acid Batteries.
- NiMH Batteries.
- Lithium-Ion Batteries.
- Nickel-Cadmium Batteries.

Lead-Acid Batteries: For the aspect of utilizing batteries, the factors that been considered were opted to their life and performance of usage. Lead acid battery been employed for this purpose. While being the most common type of car batteries, they also are the heaviest and provide the smallest amount of energy per unit weight. Although they are large, they are also the least expensive. They can also self-discharge anywhere from 3% - 20% per month.

The battery efficiency is calculated on the amount of power used from the battery while discharging divided by the amount of power delivered to the batter while charging, multiplied by 100 to yield percent. $P_{out} \times 100$ pin.

A lead acid battery has an efficiency of only 75-85%. The energy lost appears as heat and warms the battery. Keeping the charge and discharge rate of a battery low, helps to keep a battery cool and improves the battery life.



Fig: 3- Lead acid battery

Battery charger: Battery charger is used to charge the battery pack of electric vehicle. Some battery chargers are in-built and some are separate that carried always on the move. The charger converts an AC supply to DC to store power in the battery and it can be used with any normal domestic plug point. This makes charging of battery pack easy and convenient.

Voltage Converter: The voltage converter to be used in the vehicle will be provided by Elreg Distributors LTD. The converter, model number 511-1200, has an input voltage range of 24-48 volts DC and will output a voltage of 12 volts DC. This model is used specifically to operate 12 volt electronics off 24 volt vehicles. The 511-1200 has a maximum output of 300 watts or 25 amps and multiple forms of protection for the electrical subsystems.

There is protection against too much voltage, short circuits, and input polarity while also limiting the output current. There is also an automatic thermal shutdown at 90 degrees Celsius with an auto reset. There are also multiple outputs Terminals for any subsystems needed in the vehicle, and it is relatively small in size, having dimensions of approximately 7" x 5.2" x 2.7".

International Journal of Innovative Research in Science, Engineering and Technology

(An ISO 3297: 2007 Certified Organization)

Vol. 4, Issue 6, June 2015

DC Motor: Electric motors also have no emissions. Electricity, or “fuel”, for electric engines cost less per mile than gasoline. Yet, if batteries are taken into account, this does not apply. Batteries are expensive, heavy, and slow on charge. Fuel cells could be used in place of batteries but fuel cells are more expensive. Electric motors are virtually silent compared to IC engines. They may be operated by DC from a battery.

Dc motor reversing can be achieved with the use of a simple changeover switch, and when wired it changes the polarity of the voltage when operated therefore changing the direction of the motor.

As DC motor can draw lots more current under loaded conditions. It’s a good idea to ensure the DC amps rating of your switch can handle the required loaded current of the motor. A typical hook-up with the changeover switch, the switch has six connections and it been wired .This results in change in direction of motor and it been enhanced by using three position double pole changeover switch. This helps to move vehicle in forward and reverse. DC amperage exceeds 8-10 Amps.

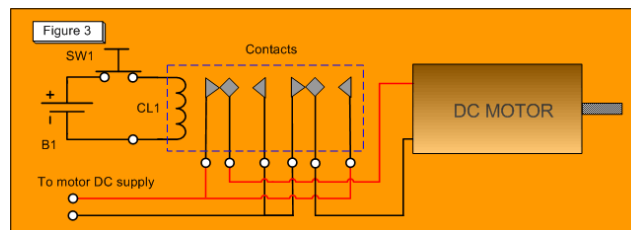

Fig: 4- Circuit Diagram of DC motor connection

Relays: Relays are the electro mechanical devices and basically consist of an electromagnet and number of contact seats. It is the same setup as the changeover switch. The only difference is is that we are going to use electricity to change the direction of motor. The prime function of relay is switching of large currents from small currents. Many configurations of relay are available, but for our purpose change over relay been used. It has two sets and each set has three connections, the common being A2 and B2. The normally open contacts being A1 & B1 and the normally closed contacts are A3 & B3.

The ‘normally’ word in the context of relays always refers to the de-energized (no power to the coil) state. The circuit shows a battery B1, to supply power to operate the relay and a simple push button switch SW1. SW1 is in open position so no contact sets A2 / A3 and B2 / B3 are electrically connected. When voltage is applied to the relay coil CL1, the magnet energizes and closes the contact set changing the connected circuits to A1 / A2 & B1 /B2.

24 volt DC changeover relay: It has the same relay but with push button in the closed (button pressured) position .This supplies voltage to the coil, energizing the magnet and moving the contacts to the energized state. The circuit also shows the wiring needed to make our motor change direction whenever the button is pressed. We have deliberately shown the DC supply to the motor as a separate connection.

This highlights the advantage of relay use – isolation – this means that the coil voltage does not have to be the same as the voltage being switched via the contacts. For example we could use a relay with a Dc coil voltage rating of 12 volts (easy to drive solid state PIC’s or transistors) and use the contacts to switch a motor with a 48 volt requirement. The two voltages had been completely isolated from each other.

International Journal of Innovative Research in Science, Engineering and Technology

(An ISO 3297: 2007 Certified Organization)

Vol. 4, Issue 6, June 2015

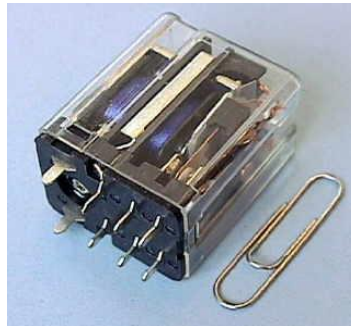

Fig: 5- 24 volt DC Changeover relay

Speedometer: A speedometer was researched that would have a range of 0-30 mph and would look appealing in the dash. During research for the gauge, several were found but were either boat gauges or bicycle gauges. Boat gauges could not be found with a sensor that would work with this vehicle and the bicycle gauges looked poorly manufactured and were hard to read. After contacting several suppliers, an LED speedometer was found that could work. However, after finding calibration for the sensor required traveling at 45 mph for 1 mile, the speedometer was deemed impractical. Speed limits below 35 mph are those in neighborhoods and school zones and are at least 15 mph.

These are areas in which 15 mph is used to state that reasonable caution should be used. Because the vehicle travels at a maximum of 35 mph, the decision was made to not use a speedometer. A speedometer for the LSV seemed to be an unnecessary expense. Once this decision was made, potential customers were notified and the reactions were a general acceptance. Although they would have liked a speedometer, they agreed that it was not a necessity.

Switches: A switch to turn on the headlights, parking lights, and defogger will be needed. It will need to be single pole and single throw (SPST). For consistency with the three-way switch, it will also be a toggle. Since there are many switches, a quick connect is desirable for easy installation. For appeal, the switch will be the same look as the three way switch. There is a safety hazard that the user may flip the wrong switch, therefore, the switches will be labeled appropriately. If it is dark out and the user cannot see the switch panel, LEDs light up the labels so the user can tell what the switch turns on. The three way switch is located on the opposite side of the dashboard next to the ignition key.

Forward/Reverse Switch: The controller is capable of allowing the vehicle to move in forward and reverse mode. A toggle, rocker, or slide switch can send a signal to the controller when the user wants to move forward or in reverse. For this operation, a double pole and double through (DPDT) switch can be used.

The switches were rated on a “+”, “-”, and “0” system of different criteria. A “+” indicates it is the best in the selected criteria and a “-” means it is the worst. A “0” means it is that neither the best nor the worst.

Head / Dome lights: The interior lights for the vehicle were determined based on value engineering. This was done by deciding what would be sufficient for lighting the interior cab while not drawing a large amount of power from the batteries. Since the dome lights researched are specifically made for full sized vehicles, the one chosen will give the operator adequate light to see inside the smaller cab. While researching possible options, the total price of the lights including wiring was considered. Once these factors were considered, bright 12 volt dome lights were decided upon.

A smaller battery operated system was initially considered in order to minimize assembly costs. In terms of materials, such as wiring, costs would have been lowered but this would have added more work for the person constructing the system, possibly even adding workers. Using the voltage converter, all of the electrical systems are connected in one manner, making assembly possible for one worker without adding more operations to the lighting systems with separate battery systems. Also charging the batteries for the entire system keeps the power for the dome light charged instead of having a separate battery in the dome light that the operator of the vehicle would have to change repeatedly as time passed. While other lights were considered, most did not have the wiring or switch supplied that would be needed. Trying to buy each part separately would have increased the price, assembly time, and

International Journal of Innovative Research in Science, Engineering and Technology

(An ISO 3297: 2007 Certified Organization)

Vol. 4, Issue 6, June 2015

complexity to the subsystem. After all of these reasons were taken into consideration, the dome light selected was found. The light features a nylon switch to turn the light on and off. The light also has separate ground and lead wires for electrical connections. The dome lens itself is made of polycarbonate Lexan. With the small interior space of the cab, one interior light will be able to provide the driver with ample light. The best possible option is to use sealed beam bifocal unit for the following reasons.

- Sealed beam head lights can be considered as a further advancement from the separate pre focused light bulb and reflector assembly. This unit incorporates the reflector and lens to form a large all glass sealed envelope filled with inert gas to replace the conventional glass bulb.
- Two heating filaments are correctly mounted inside an aluminized glass reflector by ceramic insulators. These designs provide precise filament focus as well as prevent the entry of dirt, dust, grease, and moisture so that the rapid deterioration of the reflecting properties of the reflector is avoided. Because of the very large area, filament metal transfer due to evaporation of the tungsten does not blacken glass lens.
- Its light intensity only drops off by at the most 3% of its original value during its normal four-life period, compared with a 40% reduction for the conventional double filament light bulb.

VI. DESIGN CONSIDERATIONS AND CALCULATIONS

Simple visual analysis of 3-Wheeler stability:

A) Center of gravity position:

Consider first a 4-Wheeler as seen from the rear, like here to the right. If the vehicle is in a curve towards the left, for example, we can imagine that a centrifugal force (magenta color) is exerted on the center of gravity (black and yellow circle) of the vehicle-occupants system, while the vehicle's weight exerts a downward gravitational force (cyan color).[5][6]

Thus, the centrifugal force (magenta) tends to roll the vehicle over towards the right, around an imaginary point (deep blue) under the right tires, while the gravitational force (cyan) holds the vehicle back to avoid rollover. It's as though the centrifugal force and the gravitational force combined together into a resulting force (black) exerted on the center of gravity to turn it around this imaginary point (deep blue).[2] We can thus easily understand that if the center of gravity height (red) is greater than the half-track (in green) (the half distance between the two wheels seen from the rear), the resulting force (black) will be aligned over the imaginary point (deep blue) and will thus roll the vehicle over in a curve.[3]

The ratio of the center of gravity height (red) to this half-track (green) thus plays a crucial role in determining the stability against rollover of a 4-Wheeler. Ideally, this center of gravity height (red) should be low like for a sports car, in order to insure a safety margin against rollover. In the case of 'sport-utility' 4X4s, this height is relatively larger than for regular family cars. This explains why these vehicles have a higher rollover propensity.[4]

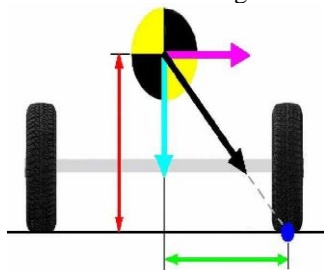

Fig: 6- Visual analysis of Centre of Gravity position

In the case of 3-Wheelers, another factor comes into play:

As can be seen for a 4-Wheeler on the illustration at the right, the 4-Wheeler rolls over around a line (blue) corresponding to the imaginary point (deep blue) of the previous illustration. But in the case of a 3-Wheeler, the vehicle rather rolls over around a line (blue) going from the unique wheel to one of the two symmetrical wheels. We can immediately see that the green line between the center of gravity and the rollover line is thus shorter than in the case of

International Journal of Innovative Research in Science, Engineering and Technology

(An ISO 3297: 2007 Certified Organization)

Vol. 4, Issue 6, June 2015

the 4-Wheeler, even though the center of gravity height, the length and the track of the 3-Wheeler are the same as those of the 4-Wheeler.[7]

The center of gravity height (red) is thus proportionately greater, which reduces the safety margin against rollover in curves. Moreover, a 3-Wheeler in a curve can also be subject to a braking or accelerating force that will combine with the lateral centrifugal force, which may further increase chances of rolling over of this 3-Wheeler. For example in the case of the single-front-wheel 3-Wheeler, here above to the right, braking in a curve towards the left will increase chances of rolling over this 3-Wheeler.[8]

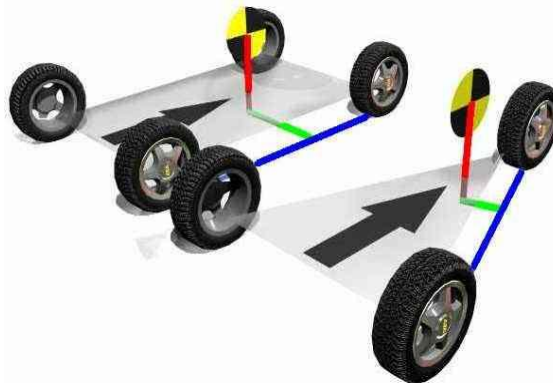
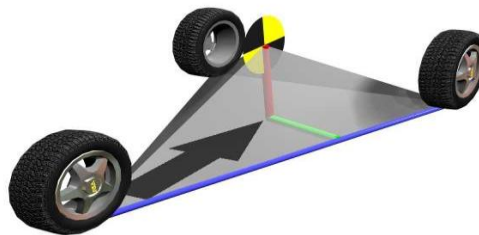

Fig: 7- Visual analysis of Centre of Gravity position and roll over axis

So in the case of a 3-Wheeler the center of gravity height should be low in relation to the half-track, like for a 4-Wheeler. But the center of gravity's position also has importance: The farther it is from the two symmetric wheels towards the single wheel, the shorter is the distance from the center of gravity to the rollover line, which reduces the safety margin against rollover of the 3-Wheeler compared to the 4-Wheeler.[10]



B) Accelerating or braking in a straight line:

When going straight, a 3-Wheeler may be accelerating or braking. Thus It may tip backward while accelerating, as in the case of a two rear wheels 3-Wheeler where the center of gravity is located too far back, - Or, while braking in the case of a two front wheels 3-Wheeler illustrated at the right, it may roll around the blue point under the front wheels and tip forward. Summarizing, the 3-Wheeler's center of gravity must be low and close to the two symmetrical wheels, that are alone to avoid a rollover in curves.[9]

But this center of gravity must not be too close to these two symmetric wheels, to avoid tipping backward or forward. Basically, the center of gravity must be located under a pyramid, as shown to the right in the case of a two-front-wheel 3-Wheeler, to avoid rolling over sideways or tipping forward.

C) Motor Vehicle Safety Regulations:

These Motor Vehicle Safety Regulations of 2003 stipulate in Standard 505 that:

"... The height of the center of mass, shown in Figure, of a motor tricycle or a three-wheeled vehicle shall not exceed one and a half times the horizontal distance from the center of mass to the nearest roll axis, shown in Figure."

International Journal of Innovative Research in Science, Engineering and Technology

(An ISO 3297: 2007 Certified Organization)

Vol. 4, Issue 6, June 2015

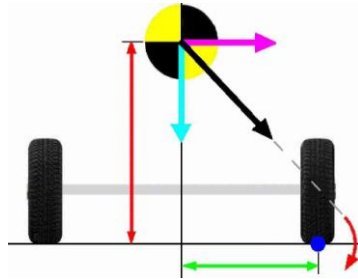

Fig: 8- Visual analysis of Centre of Gravity position with wheel roll over axis

So according to this regulation, the center of gravity height (in red) may thus be one and a half times the green line between the center of gravity and the rollover line, as illustrated at the right. The resulting force (black) may thus be aligned over the imaginary point (deep blue) and roll the vehicle over in a curve. Obviously, this regulation is very large if not too large; since it lets certain insufficiently stable vehicles circulate on public roads.

As a counter part, this new regulation has the merit of bringing order to the world of two and three wheel motorcycle definitions and regulation. Also, while avoiding going too far, there are less chances of killing the touring motorcycle aftermarket, where goodwill manufacturers can continue replacing single rear wheels by two rear wheels, on motorcycles used by goodwill people that use them carefully and do not ride fast.[13]

This regulation also stipulates in article 505, that:

"The total weight of a motor tricycle or three-wheeled vehicle on all its front wheels, as measured at the tire-ground interfaces, shall be not less than 25 per cent and not greater than 70 per cent of the loaded weight of that vehicle." The rear wheel drive car moving at constant speed up a gradient of angle Θ , the forces be $R_r + R_f = W \cos \Theta$ and $F_r = \mu R_r = W \sin \Theta$. By division

$$\tan \Theta = \mu R_r / R_r + R_f.$$

The image at the below illustrates the case of a single-front-wheel 3-Wheeler having its vehicle-occupants center of gravity located at less than 25% of the wheelbase length from the rear wheels. This leaves less than 25% of the weight on the front wheel.[15]

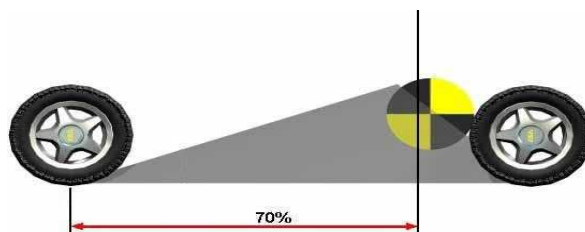

Fig: 9- Visual analysis of Centre of Gravity position from wheel base

The image above illustrates the case of a two-front-wheels 3-Wheeler having its vehicle-occupants center of gravity located at more than 70% of the wheelbase length from the rear wheel. This leaves more than 70% of the weight on the front wheel. Even though this new regulation may bring order to motorcycle definitions and regulation, it's nonetheless peculiar that:[11][12]

There is no 'mechanical' reason to treat differently these two types of 3-Wheelers: The first could 'merit' 30% of the weight on its unique front wheel. Or the second could 'merit' 75% of the weight on its two front wheels. In each of these two cases illustrated above, the vehicle-occupants center of gravity is located below the pyramid, so that the single-front-wheel will not flip backwards when accelerating and the two-front-wheel will not tip forward when braking. Summarizing, there is no reason to treat differently the risk of overturning laterally (rolling) and the risk of flipping backwards or tipping forward.[14]

International Journal of Innovative Research in Science, Engineering and Technology

(An ISO 3297: 2007 Certified Organization)

Vol. 4, Issue 6, June 2015

In both cases:

It seems more appropriate to consider overturning, flipping or tipping points or axes. And to insure an adequate ratio between the vehicle-occupants center of gravity height and the horizontal distance between the center of gravity and these points or axes, instead of a weight percentage on the front wheels.

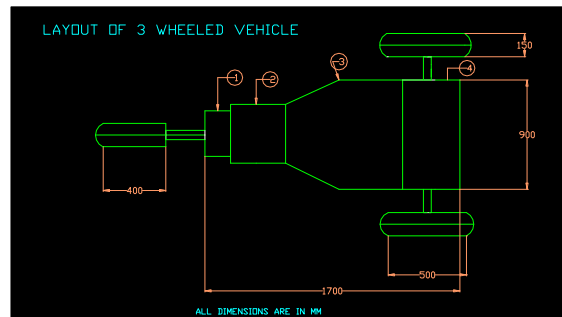

End area & Volume calculation for sections

Section 1

Pipe section = 350 mm.

Radius (r) = 3 cm.

Length (l) = 35 cm.

End area (e) = $\pi \times r^2$
e = 28.26 cm².

Volume (v) = End area \times Length
v = 989.1 cm³.

Section 2

Pipe section = 350 mm.

Radius (r) = 3 cm.

Length (l) = 30 cm.

End area (e) = $\pi \times r^2$
e = 28.26 cm².

Volume (v) = End area \times Length
v = 847.8 cm³.

Section 3

Pipe section = 350 mm.

Radius (r) = 3 cm.

Length (l) = 40 cm.

End area (e) = $\pi \times r^2$
e = 28.26 cm².

Volume (v) = End area \times Length
v = 1130.4 cm³.

Section 4

Pipe section = 350 mm.

Radius (r) = 3 cm.

Length (l) = 80 cm.

End area (e) = $\pi \times r^2$
e = 28.26 cm².

Volume (v) = End area \times Length
v = 2260.8 cm³.

International Journal of Innovative Research in Science, Engineering and Technology

(An ISO 3297: 2007 Certified Organization)

Vol. 4, Issue 6, June 2015

Density calculation for section

Section 1

Density = $m/v = 450/989.1 = 0.454 \text{ g/cm}^3$.

Section 2

Density = $m/v = 450/847.8 = 0.530 \text{ g/cm}^3$.

Section 3

Density = $m/v = 450/1130.4 = 0.398 \text{ g/cm}^3$.

Section 4

Density = $m/v = 450/2260.8 = 0.199 \text{ g/cm}^3$.

Time and Distance calculation

Initial speed = 35 m/s.

Final speed = 60 m/s.

Velocity (m/s) = Distance covered / Time taken = $ds/dt = 3.3 \text{ m/s}$.

Acceleration (a) = Change in velocity / time = $dv/dt = 0.51 \text{ m/s}$.

Friction force

Mass (m) = 450 N = 0.450 kg.

Acceleration due to gravity (g) = 9.81 m/s.

Force of gravitation = $m \times g = 0.450 \text{ kg} \times 9.81 \text{ m/s} = 4.41 \text{ KN}$.

C.O.F of material = 0.2 to 0.4.

Stress

Downward force = $(m \times g)/1000 = 4.41 \text{ KN}$.

Stress (A) =

Downward force / Cross sectional area = 19.55332 N/cm^2 .

Motion

Power (p) = Work/time.

Work (w) = Force \times Distance = 44150.

$P = 44150 / 3000 = 14.72 \text{ KW}$.

Power required = 17.31 KW.

Momentum

Initial speed = 35 m/s.

Final speed = 60 m/s.

Velocity (m/s) = Distance covered / Time taken = $ds/dt = 3.3 \text{ m/s}$.

Acceleration = (Final speed – Initial speed) / (Time taken) = 11.47 cm/s^2 .

Force = mass \times a = 0.029 N.

Moment of force

Moment = 125 N.

Moment = Applied force \times Bar length = 4.41 KN.

Gear

$V/R = \text{Driver revolution} / \text{Driven load revolution} = 2$.

Driver rpm = 120.

Driver teeth = 20.

Driven teeth = 40.

Rev ratio = 0.50: 1.

Speed = 2: 1.

Speed ratio = No of Driver teeth / Driven teeth = 1.38: 1.

Driven speed rpm = Driver rpm + Speed ratio = 4.53 rpm.

International Journal of Innovative Research in Science, Engineering and Technology

(An ISO 3297: 2007 Certified Organization)

Vol. 4, Issue 6, June 2015

Design of an electrically operated compact vehicle on different views using AutoCAD and Pro-E: (Fig 11, 12, 13, 14)

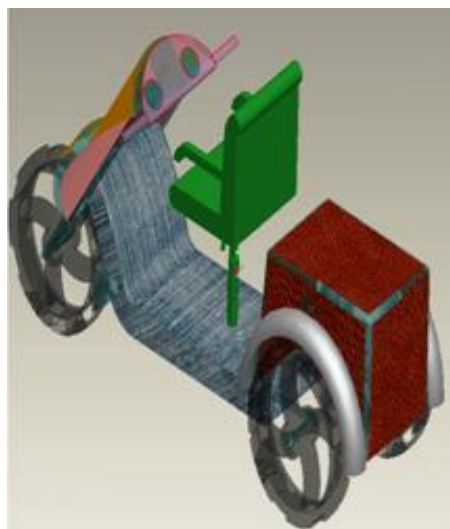
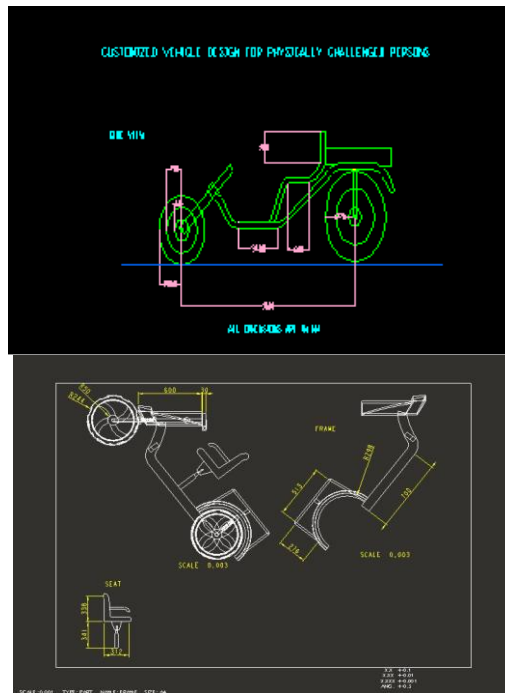

Emerging Scenario: The oil crisis is round the corner. Oil is extractive resource whose supply is deficient and exhaustive. In the context of ever rising demand for oil as a fuel base, the scientists are now searching for alternative non conventional source of energy of which electrical source of energy is considered to be more handy and cost effective. The manufacturers are bent upon producing electrically operated vehicles with option of recharging. [16]

International Journal of Innovative Research in Science, Engineering and Technology

(An ISO 3297: 2007 Certified Organization)

Vol. 4, Issue 6, June 2015



Fig: 15- Electrical power charging station

In future time is not far off to conceive an idea of inaugurating very many electrical charging stations to meet the user's demand.17]

VI.CONCLUSION

In Government sector and self employment ventures as an employee or employer should employ the design of electrically operated compact vehicle for physically challenged persons may go a long way in making them as equals with normal persons.

In forms of cost, the vehicle with some minor improvement and modifications in the physically challenged people are increasingly finding employment even present design is commercially viable and also the users can afford to buy them.

We hope that however later researchers will make it possible in the real system. We the humans have to expand our horizons and give this design a pragmatic state, as the scope for this thinking is very high.

We are sure that the information brought out in this research work is going to assist in future. We sincerely hope that this research will be a great use to the driving enthusiasts and, especially to the physically challenged people.

REFERENCES

1. 'Design data', PSG College of technology, Kalaikathir Achchagam, Coimbatore, 2007.
2. Giri.N.K, Automobile mechanics, Khanna publishers, New Delhi, 2007.
3. Das J., Paul Das M., Velusamy P., "Sesbania grandiflora leaf extract mediated green synthesis of antibacterial silver nanoparticles against selected human pathogens", Spectrochimica Acta - Part A: Molecular and Biomolecular Spectroscopy, ISSN : 1386-1425, 104(), (2013) pp.265-270.
4. 'Vehicle design' – Steven Harold.
5. <http://www.distel.co.uk> and www.Clevislauzon.com.
6. Wakitani, T. et al. U.S. Patent 7,116,065 Electric vehicle Filed: 2008, October 14.
6. Harish B.N., Menezes G.A., "Antimicrobial resistance in typhoidal salmonellae", Indian Journal of Medical Microbiology, ISSN : 0255-0857, 29(3) (2011) pp. 223-229.
7. Kocher, M. et al. U.S. Patent 7,117,044 Alternative energy system Control method and apparatus Filed: 2009, Jan 25.
8. U.S. Department of Energy, Transportation Energy Data Book Edition 2004. July 2006 (visited 15/2/2009). <http://www.eia.doe.gov/kids/energyfacts/uses/transportation.html>. Last Revised.
9. Kandasamy A., Mohan R., Caroline M.L., Vasudevan S., "Nucleation kinetics, growth, solubility and dielectric studies of L-proline cadmium chloride monohydrate semi organic nonlinear optical single crystal", Crystal Research and Technology, ISSN : 1521-4079, 43(2) (2008) pp. 186-192.
10. U.S. Department of Energy, Field Operations program, Electric and Hybrid Vehicles (visited 10/15/2006). http://avt.inel.gov/pdf/prog_info/futurecarslides2002.pdf
11. Aero rider – Ultra light Vehicle – Electric Hybrid Tricycle <http://www.aerorider.com/en/aerorider.html> (visited 2/19/07).
12. Khanaa, V., Mohanta, K., Saravanan, T., "Comparative study of uwb communications over fiber using direct and external modulations", Indian Journal of Science and Technology, ISSN : 0974-6846, 6(S6) (2013) pp.4845-4847.
13. S. Aoyagi, Y. Hasegawa, T. Yonekura, and H. Abe, "Energ efficiency improvement of series hybrid vehicle," JSAE Review, vol. 22, no. 3, pp. 259–264, 2001.

International Journal of Innovative Research in Science, Engineering and Technology

(An ISO 3297: 2007 Certified Organization)

Vol. 4, Issue 6, June 2015

14. H.S.RUPA, Role of Human Resource Manager in Managing Stress of Employees in Manufacturing Concerns , International Journal of Innovative Research in Science, Engineering and Technology , ISSN: 2319-8753, pp 10234-10237, Vol. 3, Issue 3, March 2014.
15. Kumar Giri, R., Saikia, M., "Multipath routing for admission control and load balancing in wireless mesh networks", International Review on Computers and Software, ISSN : 1828-6003, 8(3) (2013) pp. 779-785.
16. G. J. Offer, D. Howey, M. Contestabile, R. Clague, and N. P. Brandon, "Comparative analysis of battery electric, hydrogen fuel cell and hybrid vehicles in a future sustainable road transport system," Energy Policy, vol. 38, no. 1, pp. 24–29,
17. G. Ayyapan, Chemo Informatics QSAR Analysis of Nitroaromatic Compounds Toxicity, International Journal of Innovative Research in Science, Engineering and Technology, ISSN: 2319-8753, pp 372-375, Vol. 2, Issue 2, February 2013.
18. G. Mathubala , Dr. T. Jayadoss, Evaluation of Non-Conventional Fertilizers On The Growth Response of Zinnia Seedlings , International Journal of Innovative Research in Science, Engineering and Technology, ISSN: 2319-8753, pp 8360-8376 , Vol. 3, Issue 1, January 2014.
19. G. Mathubala , S. Rosy Christy , Hazardous Materials - Restriction, International Journal of Innovative Research in Science, Engineering and Technology, ISSN: 2319-8753 , pp 4398-4400 , Vol. 2, Issue 9, September 2013.
20. G. Mathubala, Dr. V. Krishnasamy , KINETICS OF OXIDATION OF SCHIFF BASE BY CHLORAMINE –T CATALYSED BY MIXTURE OF Os (VIII) AND Ru (III) – EFFECT OF OSMIUM TETRAOXIDE AND RUTHENIUM CHLORIDE , International Journal of Innovative Research in Science, Engineering and Technology , ISSN: 2319-8753 , pp 2756-2762, Vol. 2, Issue 7, July 2013 .
21. G. Mathubala, Dr. V. Krishnasamy , KINETICS OF OS(VIII) CATALYSED OXIDATION OF BENZALDEHYDE ANILS BY PDC – STUDY OF THE EFFECTS OF SUBSTRATE , International Journal of Innovative Research in Science, Engineering and Technology , ISSN: 2319-8753 , pp 2467-2472 , Vol. 2, Issue 5, May 2013.